

Page	Description
1	Table of Contents
2	Controller Layout
3	Audio
4	Audio, Premium Amp
5	Audio, RHD
6	Brake Controls
7	CAN Chassis
8	CAN Party
9	CAN Vehicle
10	Center Console
11	Charge Port Inlet
12	Diagnostics
13	Door Front Left
14	Door Front Right
15	Door Rear
16	Drive Inverters
17	Driver Assistance
18	Driver Assistance, RHD
19	Frunk Actuators/Sensors
20	Grounding - Cabin
21	Grounding - Frunk
22	Grounding - Liftgate
23	Headliner
24	HV Battery & HVIL
25	HV Penthouse
26	HVAC - Cabin
27	HVAC - Heat Pump
28	HVAC - Powertrain
29	HVAC Case
30	Instrument Panel
31	Liftgate and Trunk
32	Lighting - Exterior
33	Power Distribution - Main
34	Power Distribution - VCFront 1/2
35	Power Distribution - VCFront 2/2
36	Power Distribution - VCLeft 1/2
37	Power Distribution - VCLeft 2/2
38	Power Distribution - VCRight 1/2
39	Power Distribution - VCRight 2/2
40	Restraint Controller - Airbags
41	Restraint Controller - Retractors
42	Restraint Controller - Sensors
43	RF/Special Cables
44	RF/Special Cables, RHD
45	Seats Front Left
46	Seats Front Right
47	Seats Second Row 40%
48	Seats Second Row 60%
49	Seats Second Row Cushion 5-Seater
50	Seats Second Row Cushion 7-Seater
51	Seats Third Row
52	Security Controls
53	Steering
54	Towing
55	Windshield Wiper/Washer/Heater

Table 5: Option Codes	
LHST	Left side Seat
RHST	Right Side Seat
FOG	Fog Light
PCOLM	Power Steering Column
PAUDIO	Premium Audio
COLDW	Cold Weather Package
LHD	Left Hand Drive
RHD	Right Hand Drive
AWD	All Wheel Drive
RWD	Rear Wheel Drive
PINLT	Premium Interior Lights
PMIRR	Premium Mirror with Powerfold
REEU	Region Europe
RENA	Region North America
RECN	Region China
CSUSP	Coil Suspension
PREMST	Premium Seat
SBR	Seat Belt Reminder Switch
OCS	Occupant Classification System
STPS	Seat Track Position Sensor
CPGB	Chargeport GB
FSAB	Farside Airbag

Table 1: Abbreviations

LF	Left Front	RF	Right Front
LR	Left Rear	RR	Right Rear
LHS	Left-Hand Side	RHS	Right-Hand Side

Table 2: Harness Designators

A	LH BODY	R	LH RR DOOR
B	RH BODY	S	RH RR DOOR
C	CENTER CONSOLE	T	LIFT GATE
D	LH FR DOOR	TT	LIFT GATE TRIM
F	FR FASCIA	U	THERMAL
G	RR FASCIA	UHP	THERMAL, HEAT PUMP
H	HV PENTHOUSE	V	GLASS
J	IP	W	FRUNK
K	HEADLINER	X	REAR SUBFRAME
L	FRONT END MODULE	Y	FRONT SEATS
N	FRONT SUBFRAME	Z	MISC. CABLES
P	RH FR DOOR		

Table 3: Wire Color Designators

BK	Black	OG	Orange
BN	Brown	RD	Red
BU	Blue	VT	Violet (Purple)
GN	Green	WH	White
GY	Gray	YE	Yellow

Table 4: Wire Type Designators

FLRY	Thin wall 105C rated, regular stranded PVC insulated [FLRY-A]
FLRB	Thin wall 105C rated, bunched conductor PVC insulated [FLRY-B]
MCIIV	Thin wall 105C rated, compressed conductor PVC (halogen free) insulated
XR15	Thin wall 150C rated, cross-linked polyolefin, high flexible
FLXB	Thin wall 125C rated, cross-linked polyolefin, high flexible, halogen free insulated
3TBL	Thick wall 105C rated, aluminum conductor PVC insulated
F91X	Thin wall 150C rated, cross-linked polyethylene, high flexible

General Notes:

- Switches [Relays] are shown in their inactive [de-energized] state.
- Splices may be split across pages for visual clarity with respect to the function displayed on the particular page.
- Some connectors are split across multiple pages for clarity.
There is no overall reference in this document for the signals routed to a specific connector.
- Wire sizes are specified in mm² cross-sectional area (CSA) per SAE 1127/8
- Wire Specification: 60V, thin-wall PVC (ISO type or equivalent).
Default wire type to be rated 60VDC/25VAC and -40C to 105C operating temperature.
See DIN 13602 or ISO 6722 for detailed specifications.
- Unless otherwise specified at the device pins, terminal plating is to be Tin or Pre-Tin

TERMINAL PLATING

- GOLD TERMINAL NECESSARY
- SILVER PLATING NECESSARY

- Inline connector gender specification is based on the terminal type.
Inline connectors with "M" suffix have male, tab or pin terminals
Inline connectors with "F" suffix have female, receptacle or socket terminals

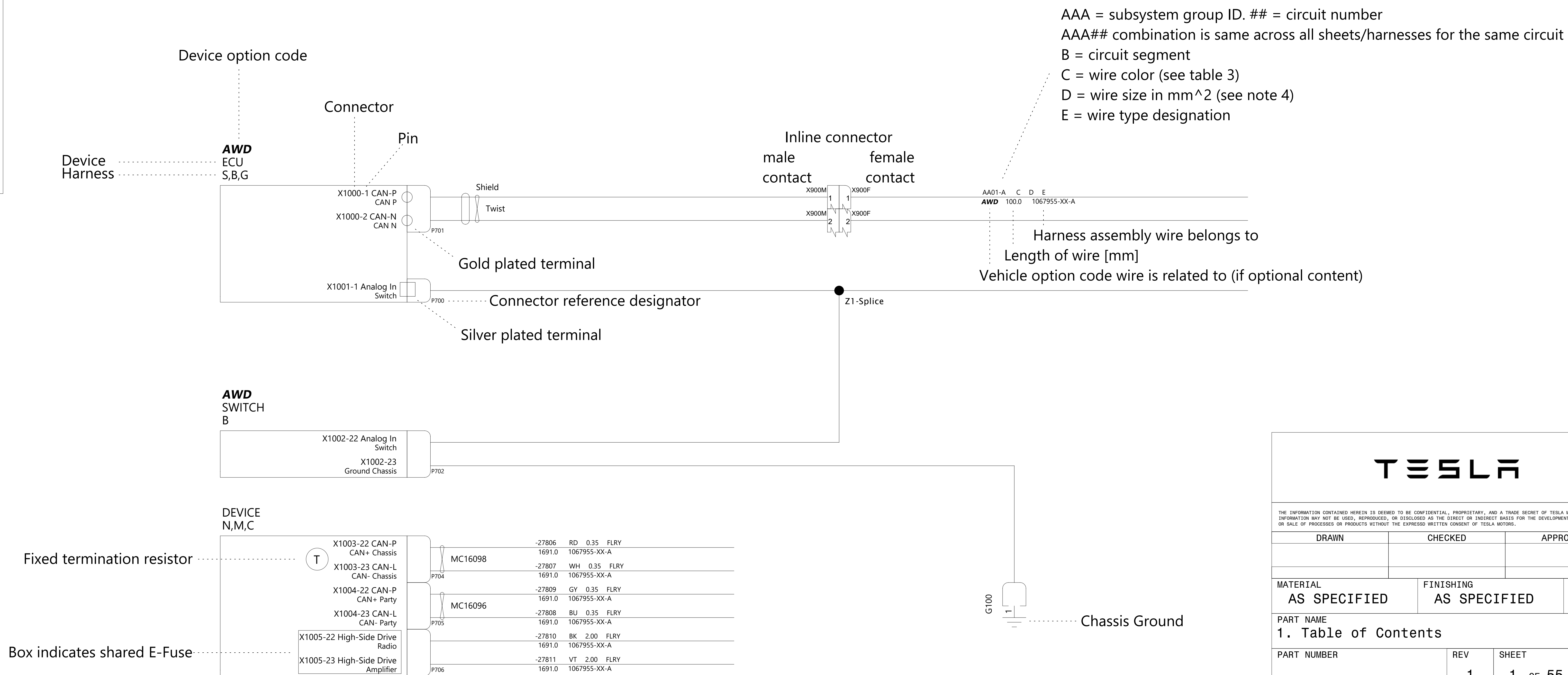

THE INFORMATION CONTAINED HEREIN IS DEEMED TO BE CONFIDENTIAL, PROPRIETARY, AND A TRADE SECRET OF TESLA MOTORS. THIS INFORMATION MAY NOT BE USED, REPRODUCED, OR DISCLOSED AS THE DIRECT OR INDIRECT BASIS FOR THE DEVELOPMENT, MANUFACTURE, OR SALE OF PROCESSES OR PRODUCTS WITHOUT THE EXPRESS WRITTEN CONSENT OF TESLA MOTORS.			
DRAWN	CHECKED	APPROVED	
MATERIAL AS SPECIFIED	FINISHING AS SPECIFIED	SCALE NONE	
PART NAME 1. Table of Contents			
PART NUMBER	REV	SHEET	SIZE
	1	1 OF 55	A0

Left Controller

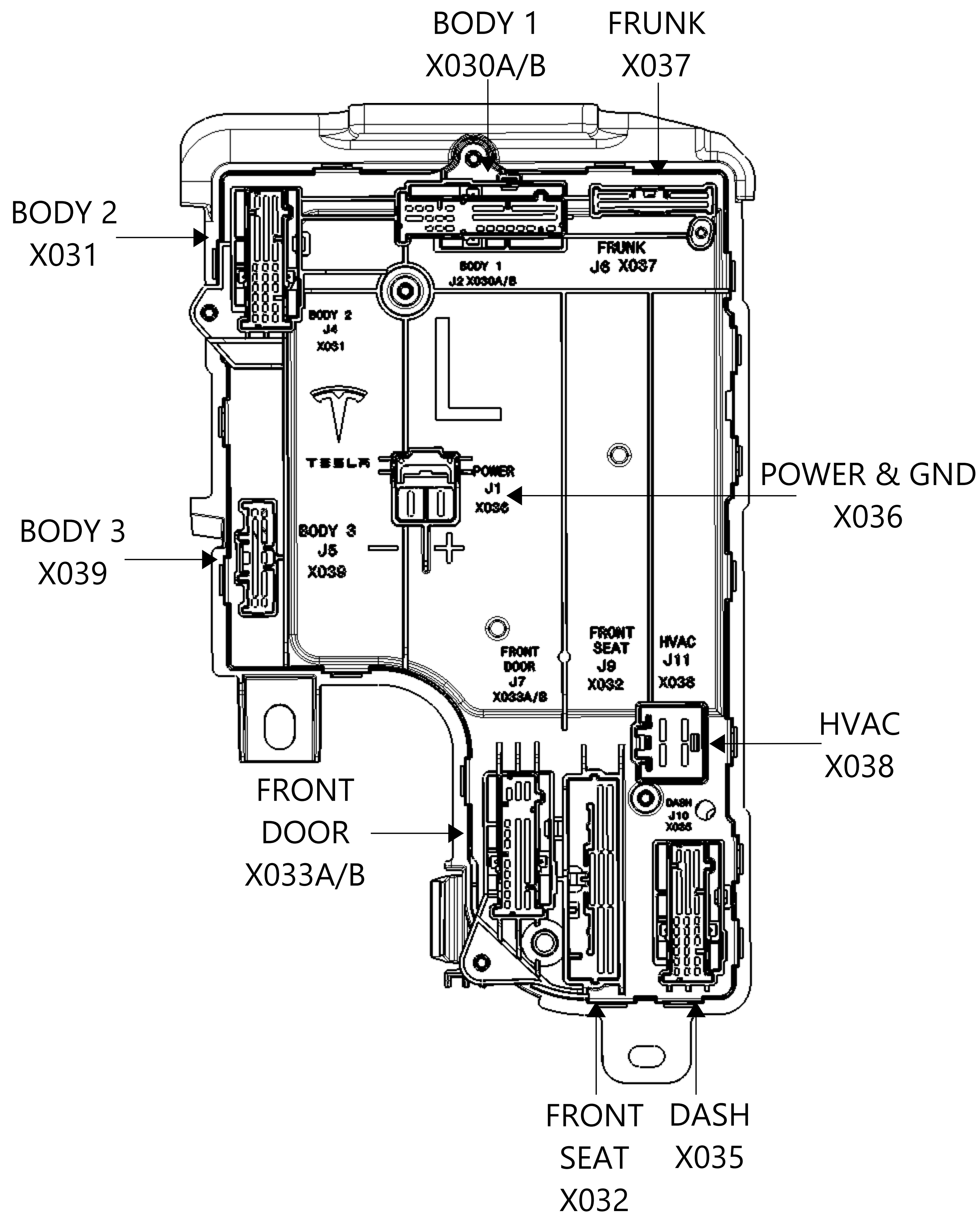

Front Controller

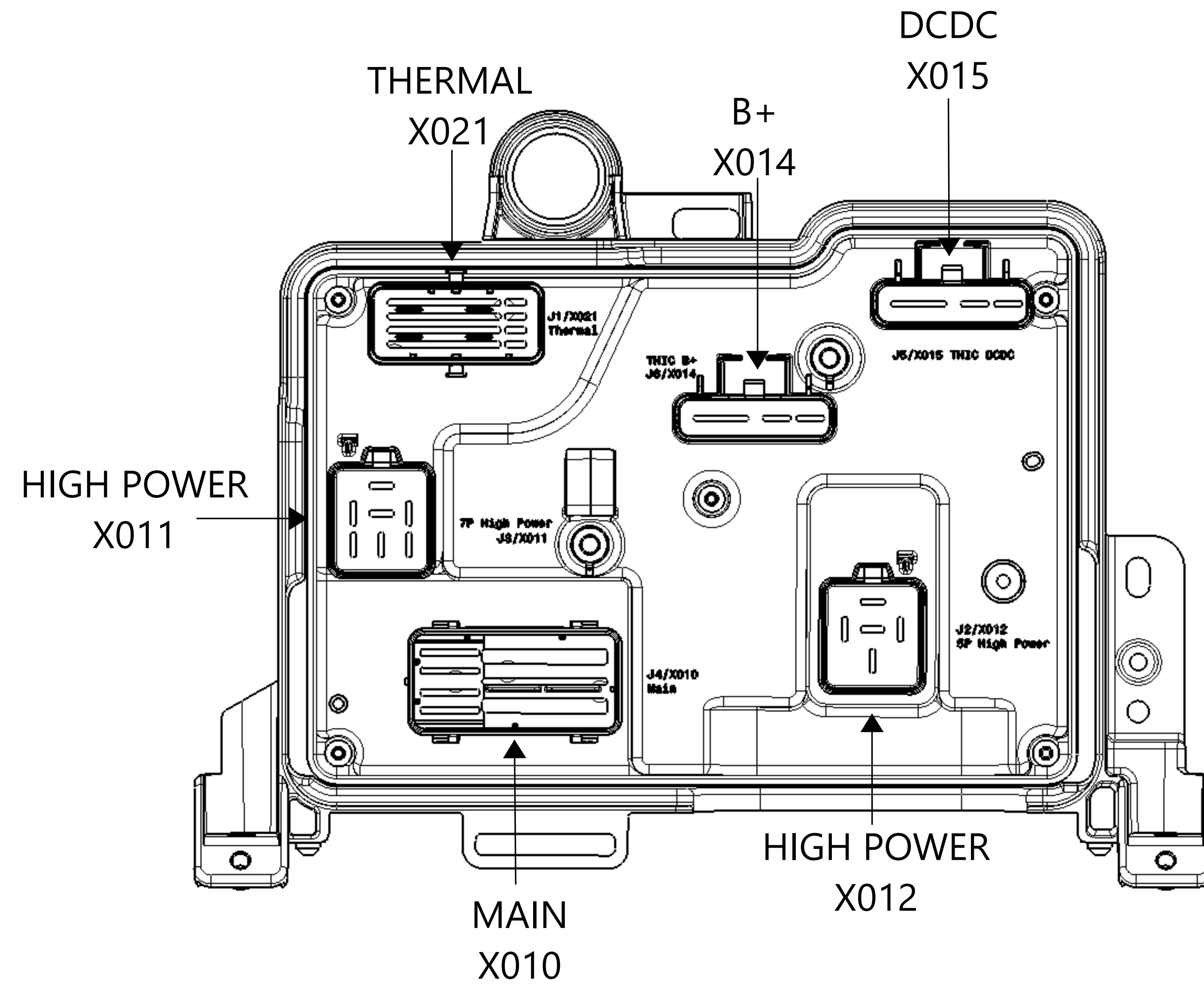

Right Controller

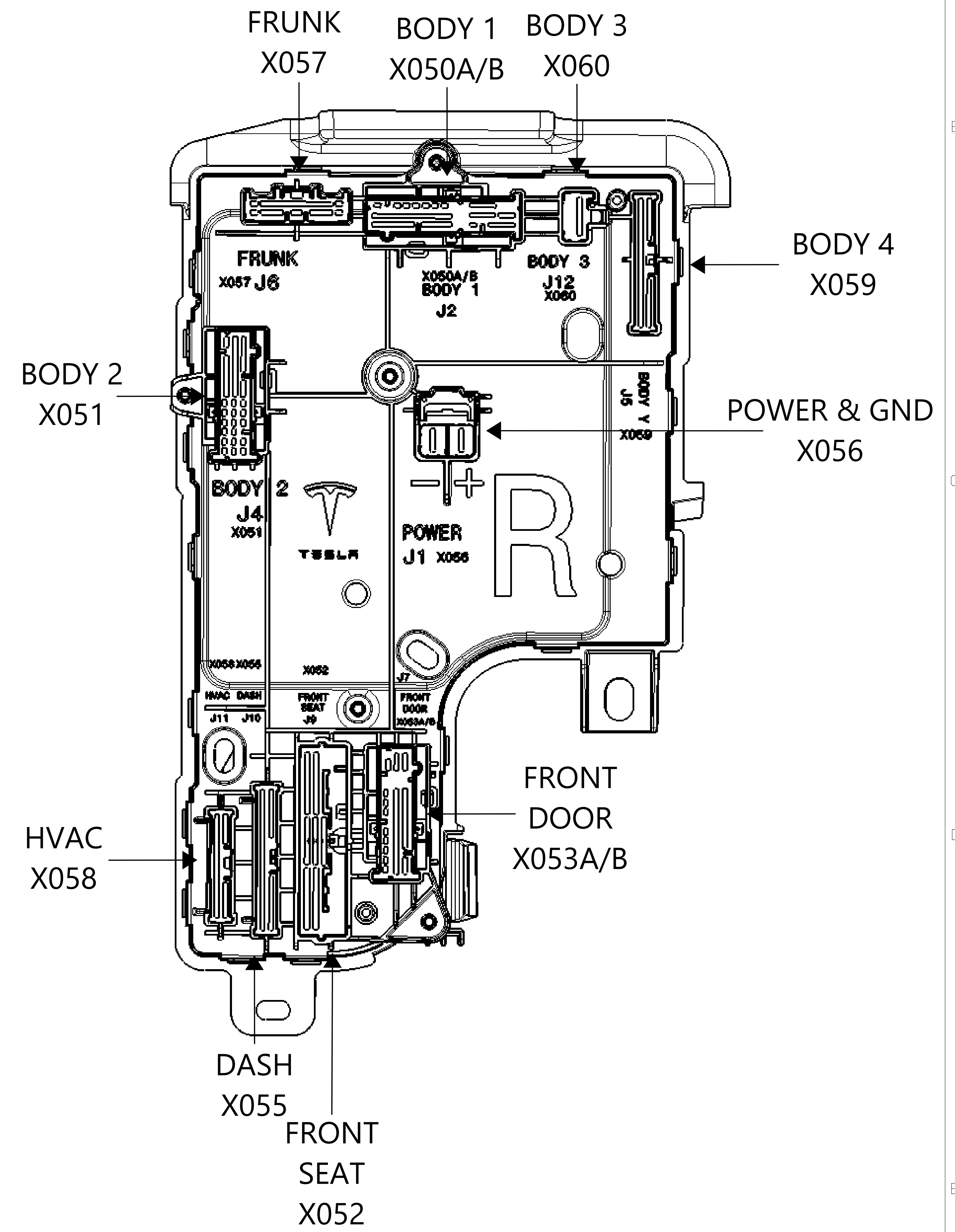

TESLA

THE INFORMATION CONTAINED HEREIN IS DEEMED TO BE CONFIDENTIAL, PROPRIETARY, AND A TRADE SECRET OF TESLA MOTORS. THIS INFORMATION MAY NOT BE USED, REPRODUCED, OR DISCLOSED AS THE DIRECT OR INDIRECT BASIS FOR THE DEVELOPMENT, MANUFACTURE, OR SALE OF PROCESSES OR PRODUCTS WITHOUT THE EXPRESS WRITTEN CONSENT OF TESLA MOTORS.

DRAWN	CHECKED	APPROVED
MATERIAL AS SPECIFIED	FINISHING AS SPECIFIED	SCALE NONE
PART NAME 2. Controller Layout		
PART NUMBER	REV	SHEET
	1	2 OF 55
		SIZE A0

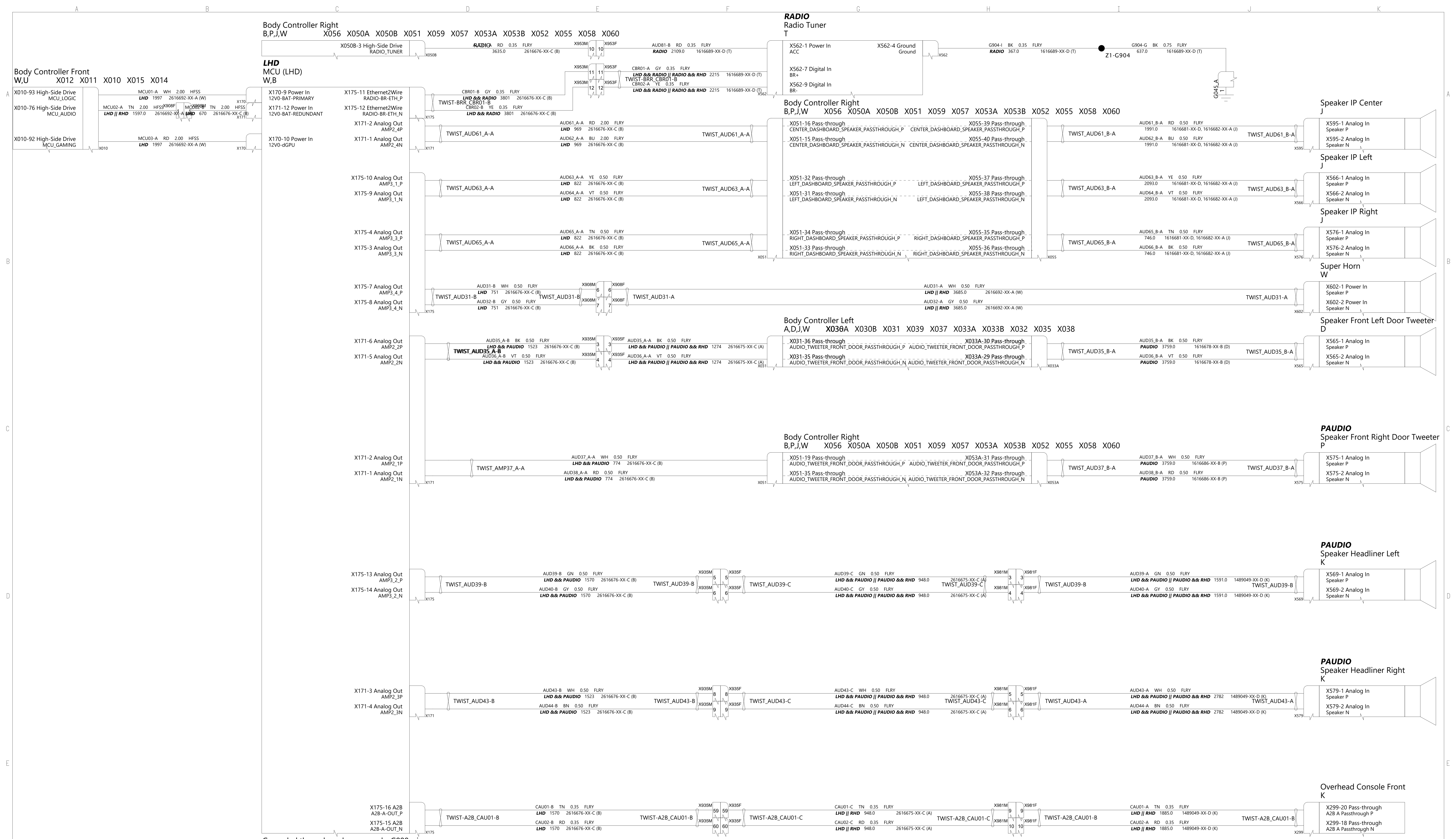

THE INFORMATION CONTAINED HEREIN IS DEEMED TO BE CONFIDENTIAL, PROPRIETARY, AND A TRADE SECRET OF TESLA MOTORS. THIS INFORMATION MAY NOT BE USED, REPRODUCED, OR DISCLOSED AS THE DIRECT OR INDIRECT BASIS FOR THE DEVELOPMENT, MANUFACTURE, OR SALE OF PROCESSES OR PRODUCTS WITHOUT THE EXPRESSED WRITTEN CONSENT OF TESLA MOTORS.

DRAWN	CHECKED	APPROVED

MATERIAL AS SPECIFIED	FINISHING AS SPECIFIED	SCALE NONE

PART NAME
Audio

PART NUMBER	REV	SHEET	SIZE
	1	3 OF 55	A0

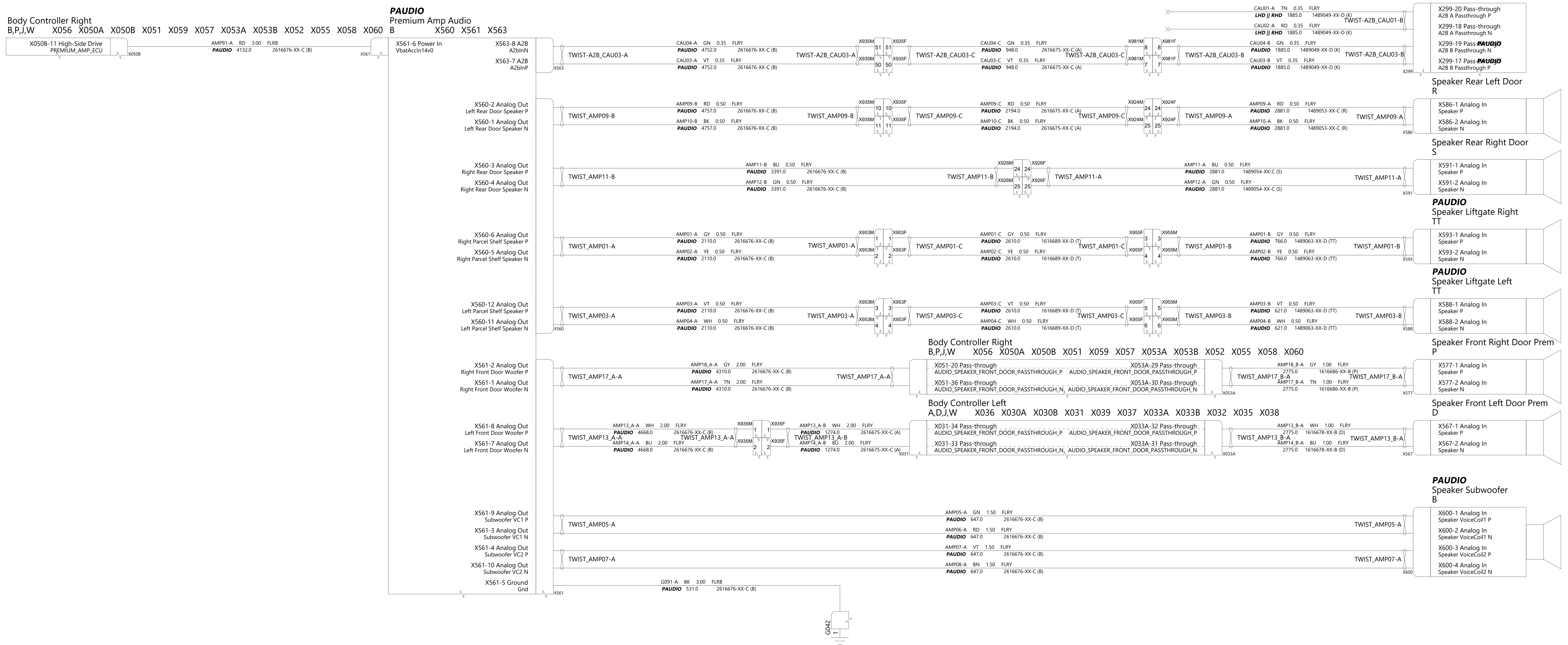

TESLA

THE INFORMATION CONTAINED HEREIN IS DEEMED TO BE CONFIDENTIAL, PROPRIETARY, AND A TRADE SECRET OF TESLA MOTORS. THIS INFORMATION MAY NOT BE USED, REPRODUCED, OR DISCLOSED AS THE DIRECT OR INDIRECT BASIS FOR THE DEVELOPMENT, MANUFACTURE, OR SALE OF PROCESSES OR PRODUCTS WITHOUT THE EXPRESSED WRITTEN CONSENT OF TESLA MOTORS.

DRAWN	CHECKED	APPROVED
-------	---------	----------

MATERIAL AS SPECIFIED	FINISHING AS SPECIFIED	SCALE NONE
--------------------------	---------------------------	---------------

PART NAME
Audio, Premium Amp

PART NUMBER	REV	SHEET	SIZE
	1	4 OF 55	A0

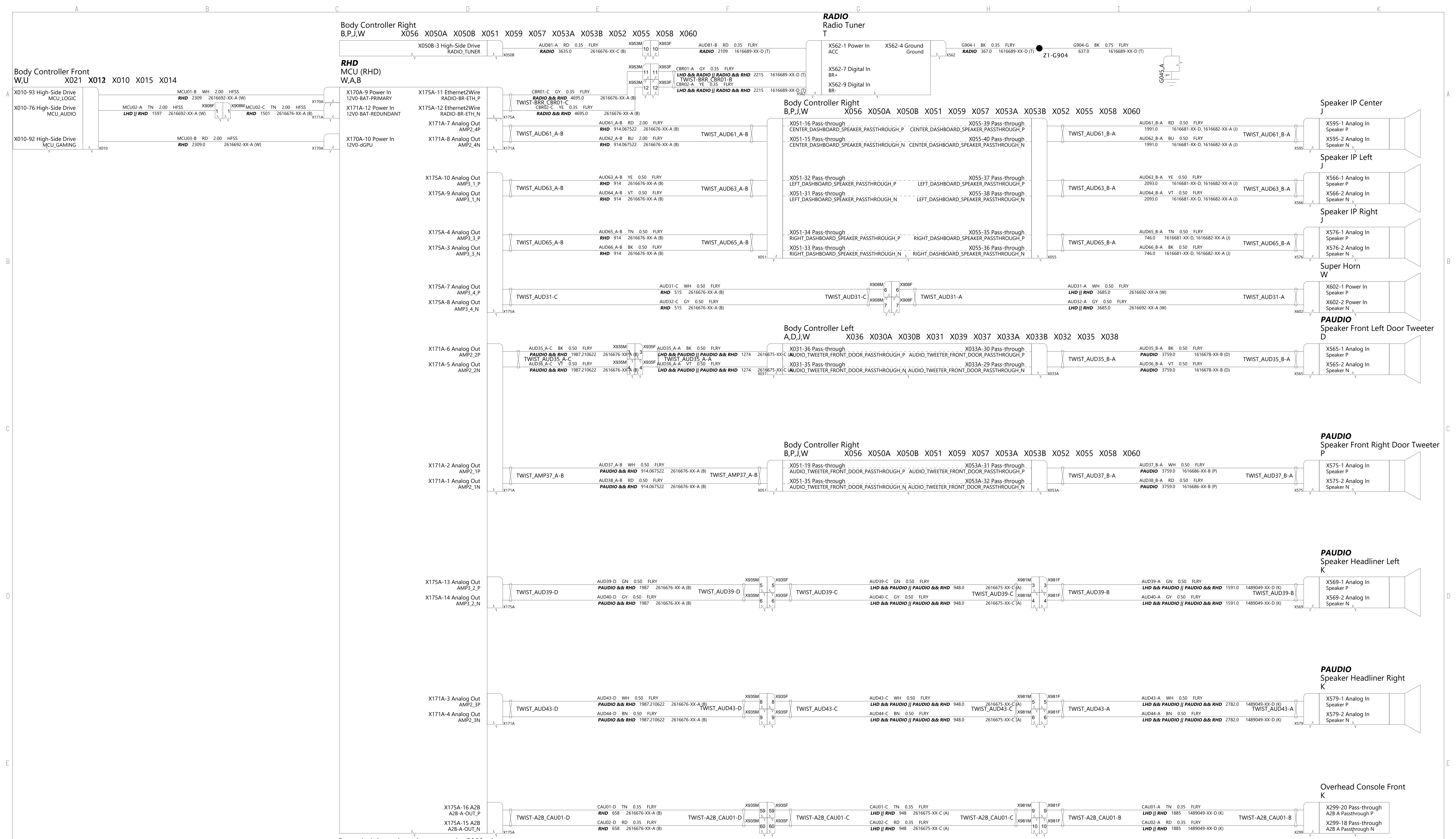

Grounded through enclosure and +G999 wire



THE INFORMATION CONTAINED HEREIN IS DEEMED TO BE CONFIDENTIAL, PROPRIETARY, AND A TRADE SECRET OF TESLA MOTORS. THIS INFORMATION MAY NOT BE USED, REPRODUCED, OR DISCLOSED AS THE OBJECT OR INSTRUMENT BASIS FOR THE DEVELOPMENT, MANUFACTURE, OR SALE OF PROCESSES OR PRODUCTS WITHOUT THE EXPRESSED WRITTEN CONSENT OF TESLA MOTORS.

DRAWN	CHECKED	APPROVED
MATERIAL AS SPECIFIED	FINISHING AS SPECIFIED	SCALE NONE
PART NAME Audio, RHD		
PART NUMBER	REV	SHEET
	1	5 OF 55
		SIZE A0

LHD
Autopilot ECU (LHD)
W,J,B



HCU/ESP
W

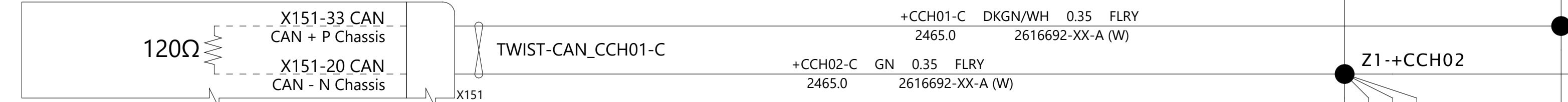

RHD
EPAS (RHD)
W

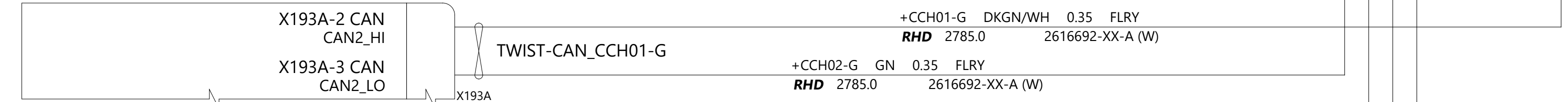

LHD
iBooster & DTS (LHD)
W X150 X158 X159



RHD
iBooster & DTS (RHD)
W X150A X158A X159A

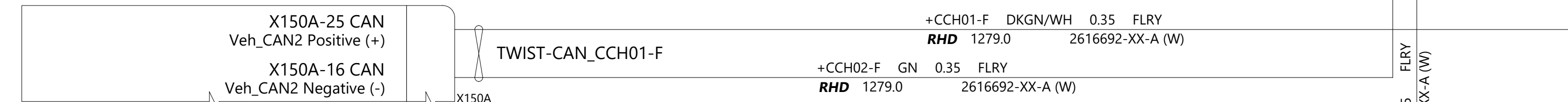

RHD
MCU (RHD)
W,A,B

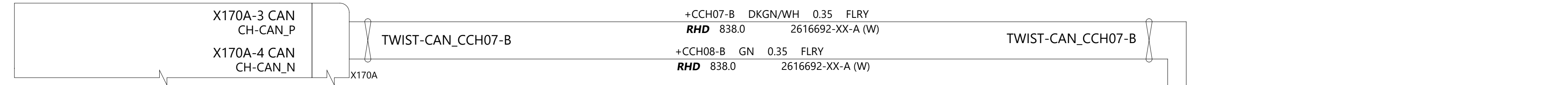

LHD
MCU (LHD)
W,B

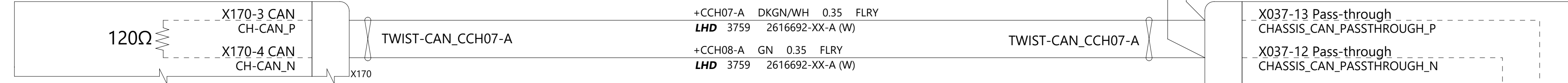

RHD
Autopilot ECU (RHD)
W,J,B

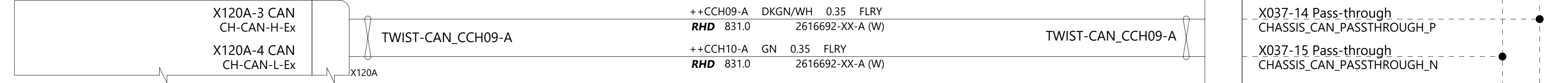

LHD
EPAS (LHD)
W

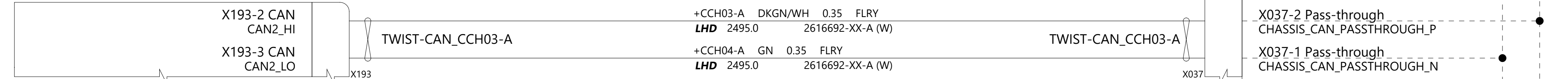

Restraints Controller
A,J X200 X201

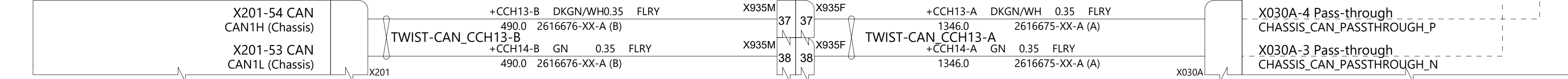

OCS
OCS
Y

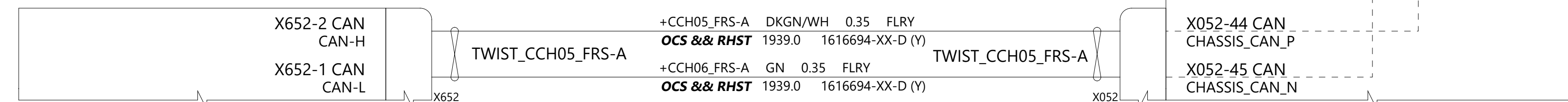

Body Controller Left
A,D,J,W

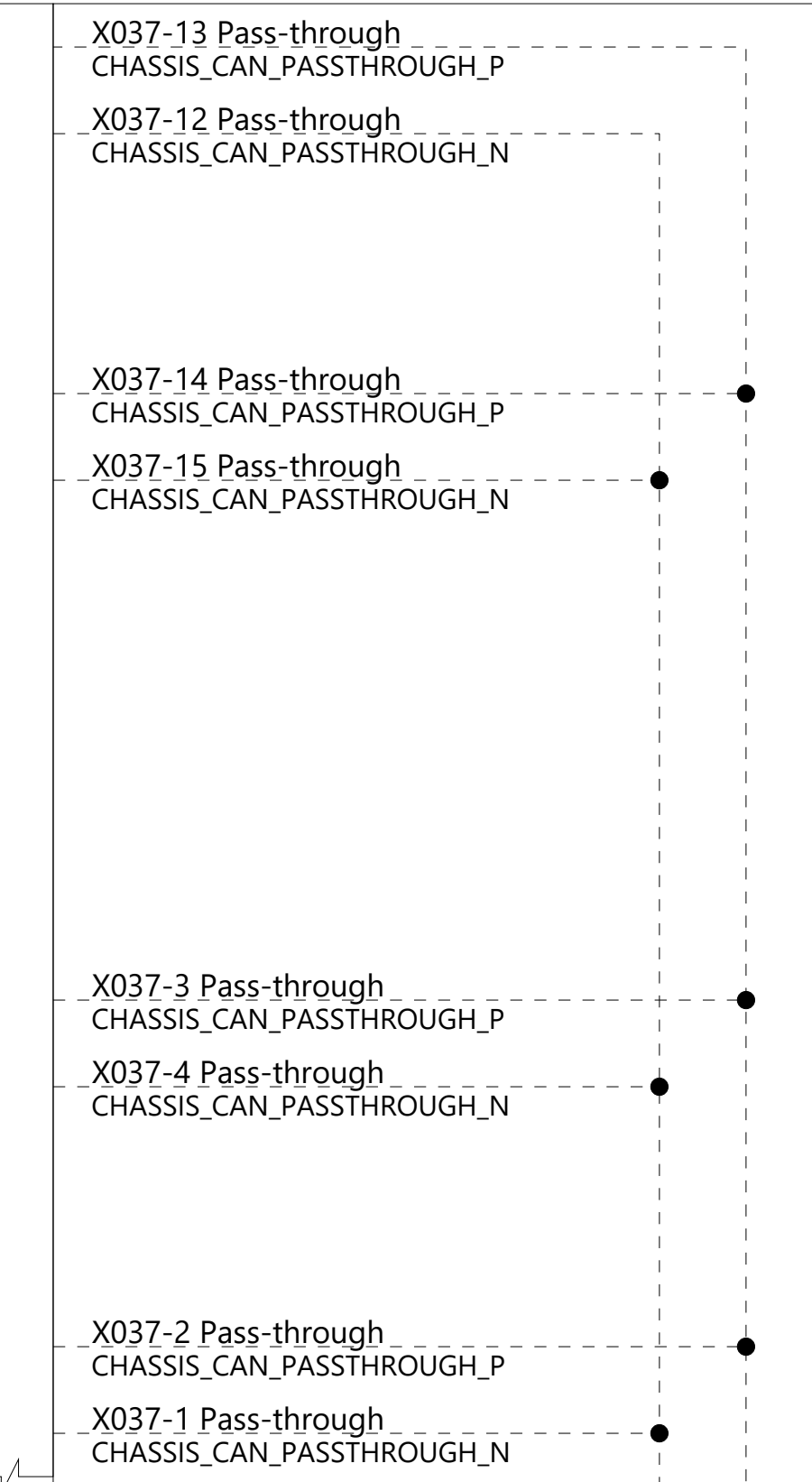

Body Controller Right
B,P,J,W

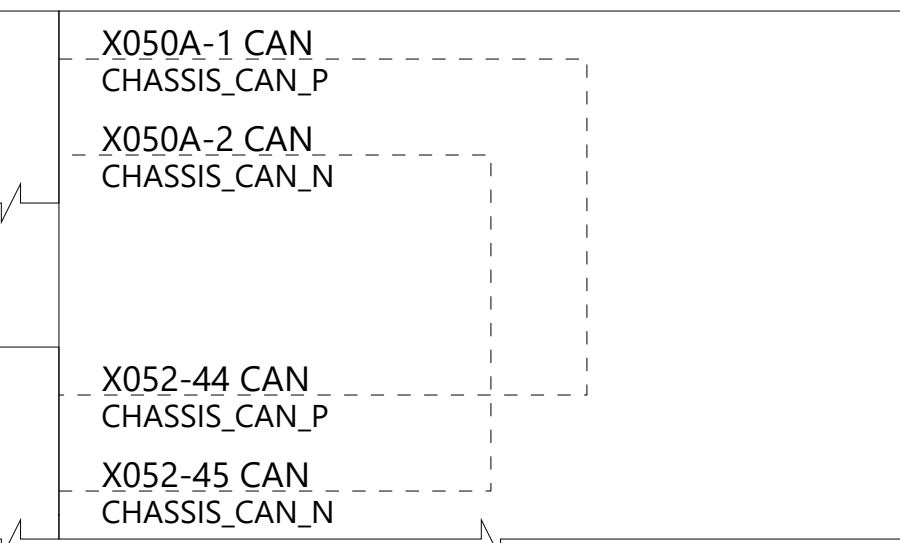

THE INFORMATION CONTAINED HEREIN IS DEEMED TO BE CONFIDENTIAL, PROPRIETARY, AND A TRADE SECRET OF TESLA MOTORS. THIS INFORMATION MAY NOT BE USED, REPRODUCED, OR DISCLOSED AS THE DIRECT OR INDIRECT BASIS FOR THE DEVELOPMENT, MANUFACTURE, OR SALE OF PROCESSES OR PRODUCTS WITHOUT THE EXPRESSED WRITTEN CONSENT OF TESLA MOTORS.

DRAWN	CHECKED	APPROVED
MATERIAL AS SPECIFIED	FINISHING AS SPECIFIED	SCALE NONE
PART NAME CAN Chassis		
PART NUMBER	REV	SHEET
	1	7 OF 55
		A0

Body Controller Front
W,U X02 X012 X011 X010 X015 X014

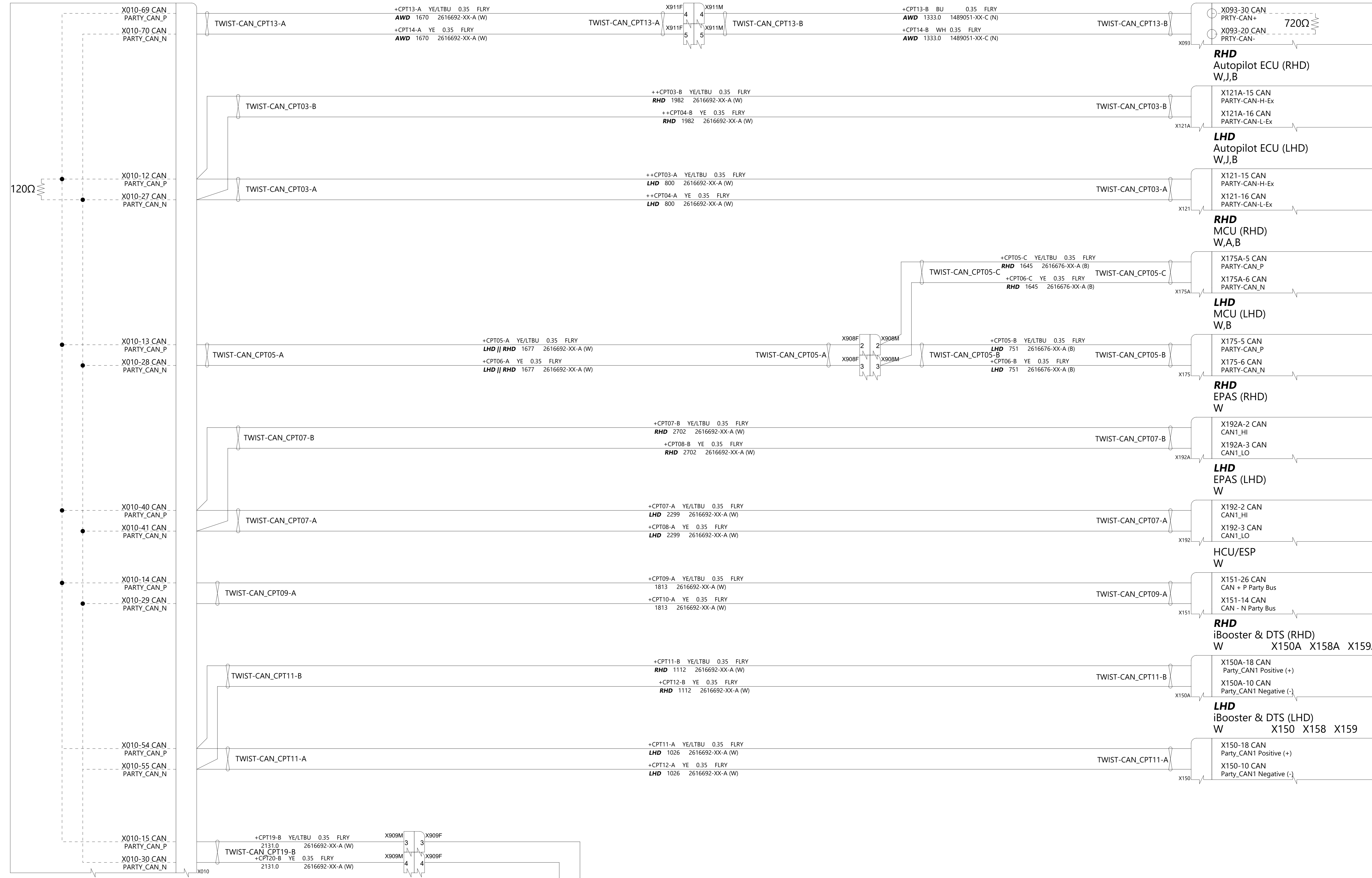

Body Controller Left
A,D,J,W X036 X030A X030B X031 X039 X037 X033A X033B X032 X035 X038

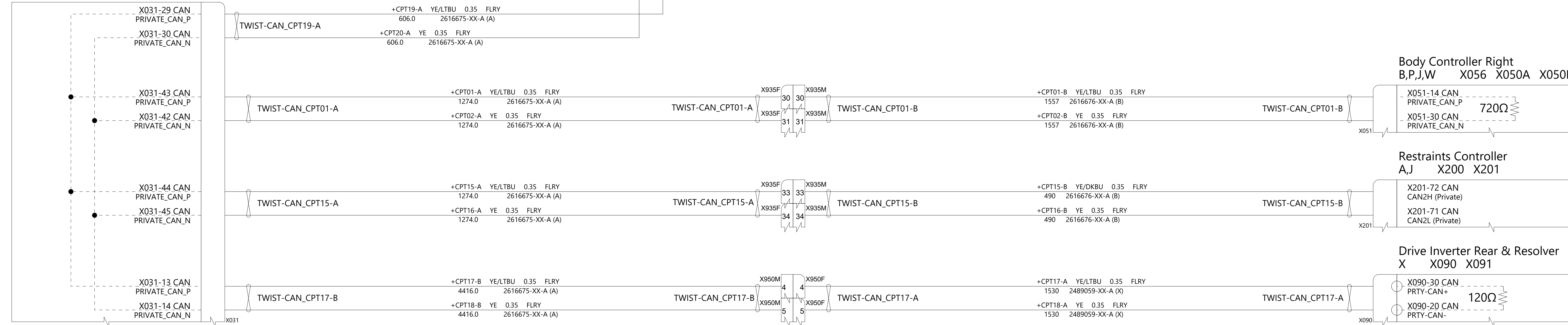

THE INFORMATION CONTAINED HEREIN IS DEEMED TO BE CONFIDENTIAL, PROPRIETARY, AND A TRADE SECRET OF TESLA MOTORS. THIS INFORMATION MAY NOT BE USED, REPRODUCED, OR DISCLOSED AS THE DIRECT OR INDIRECT BASIS FOR THE DEVELOPMENT, MANUFACTURE, OR SALE OF PROCESSES OR PRODUCTS WITHOUT THE EXPRESSED WRITTEN CONSENT OF TESLA MOTORS.

DRAWN	CHECKED	APPROVED
MATERIAL AS SPECIFIED	FINISHING AS SPECIFIED	SCALE NONE
PART NAME CAN Party		
PART NUMBER	REV	SHEET
	1	8 OF 55
		A0

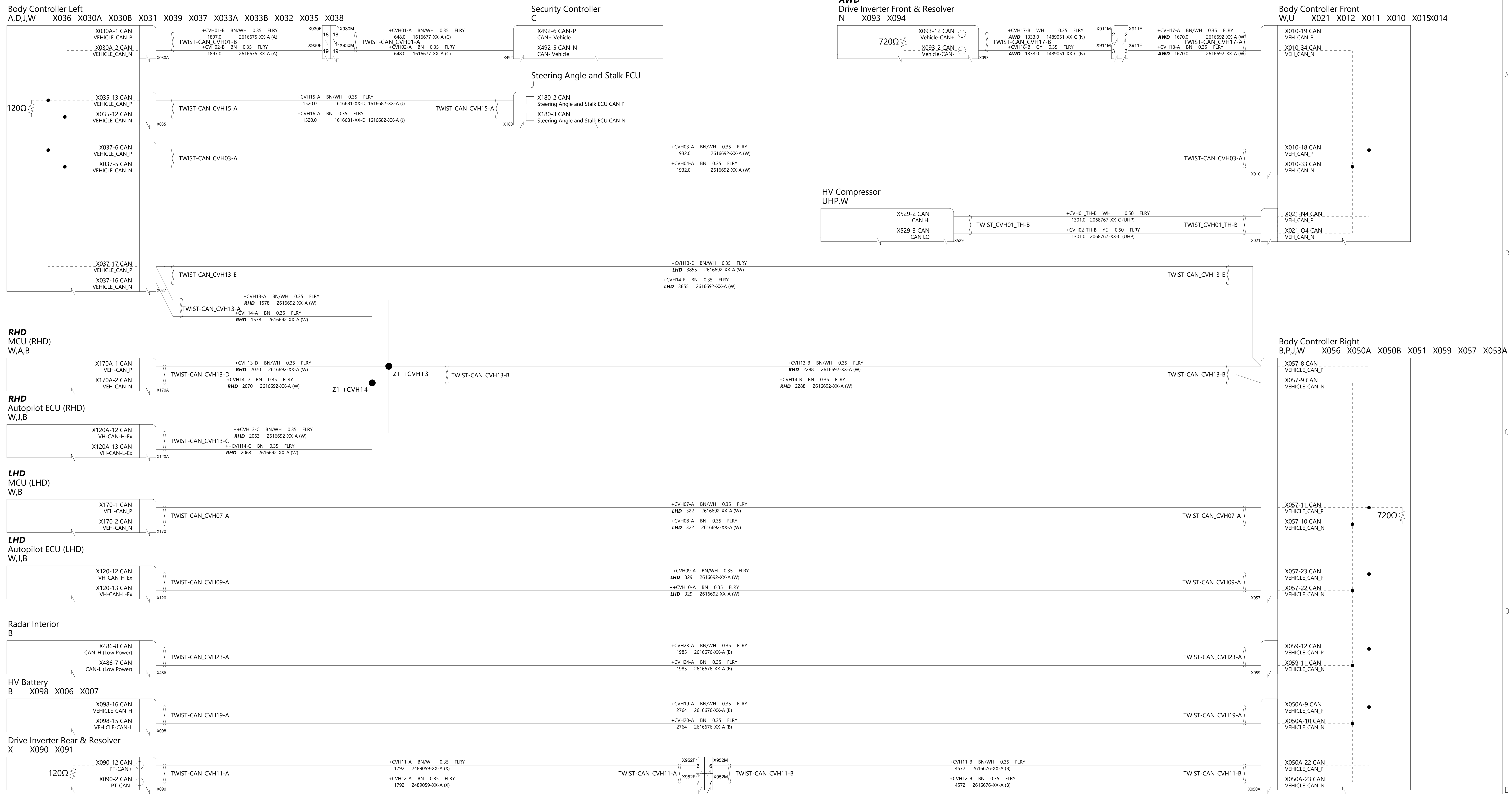

THE INFORMATION CONTAINED HEREIN IS DEEMED TO BE CONFIDENTIAL, PROPRIETARY, AND A TRADE SECRET OF TESLA MOTORS. THIS INFORMATION MAY NOT BE USED, REPRODUCED, OR DISCLOSED AS THE DIRECT OR INDIRECT BASIS FOR THE DEVELOPMENT, MANUFACTURE, OR SALE OF PROCESSES OR PRODUCTS WITHOUT THE EXPRESS WRITTEN CONSENT OF TESLA MOTORS.

DRAWN	CHECKED	APPROVED
MATERIAL AS SPECIFIED	FINISHING AS SPECIFIED	SCALE NONE
PART NAME CAN Vehicle		
PART NUMBER	REV	SHEET
	1	9 OF 55
		SCALE A0

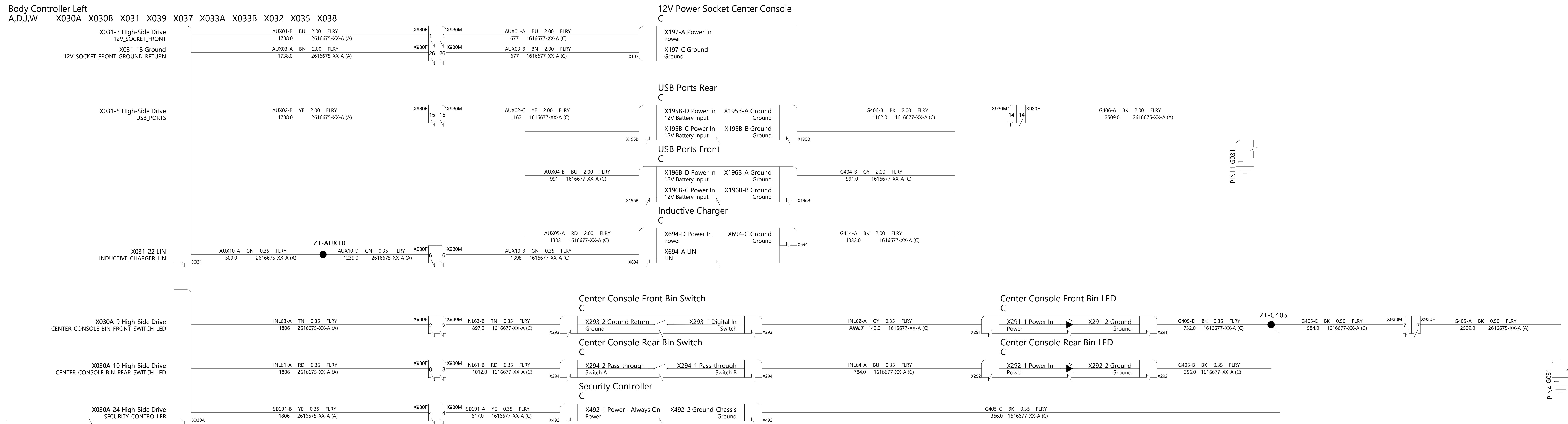

TESLA

THE INFORMATION CONTAINED HEREIN IS DEEMED TO BE CONFIDENTIAL, PROPRIETARY, AND A TRADE SECRET OF TESLA MOTORS. THIS INFORMATION MAY NOT BE USED, REPRODUCED, OR DISCLOSED AS THE DIRECT OR INDIRECT BASIS FOR THE DEVELOPMENT, MANUFACTURE, OR SALE OF PROCESSES OR PRODUCTS WITHOUT THE EXPRESSED WRITTEN CONSENT OF TESLA MOTORS.

DRAWN	CHECKED	APPROVED
MATERIAL AS SPECIFIED	FINISHING AS SPECIFIED	SCALE NONE
PART NAME Center Console		
PART NUMBER	REV	SHEET
	1	10 of 55
		SIZE
		A0

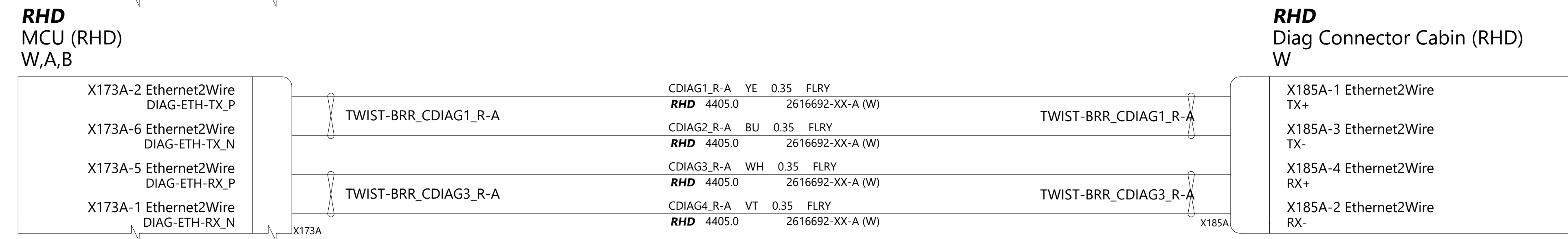
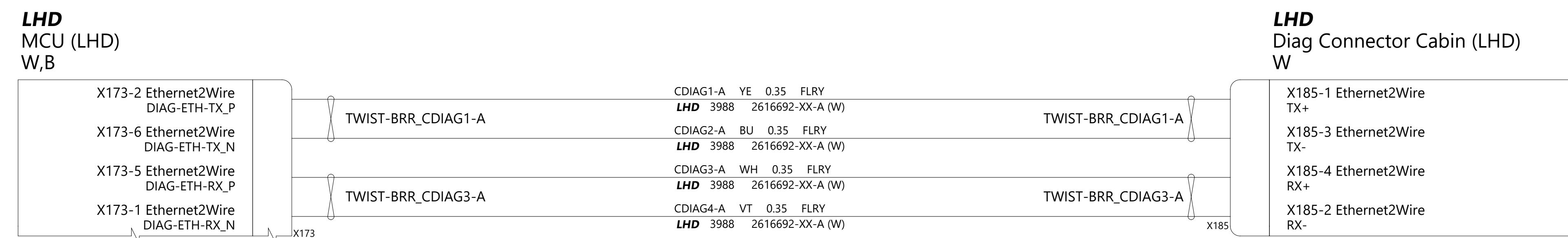
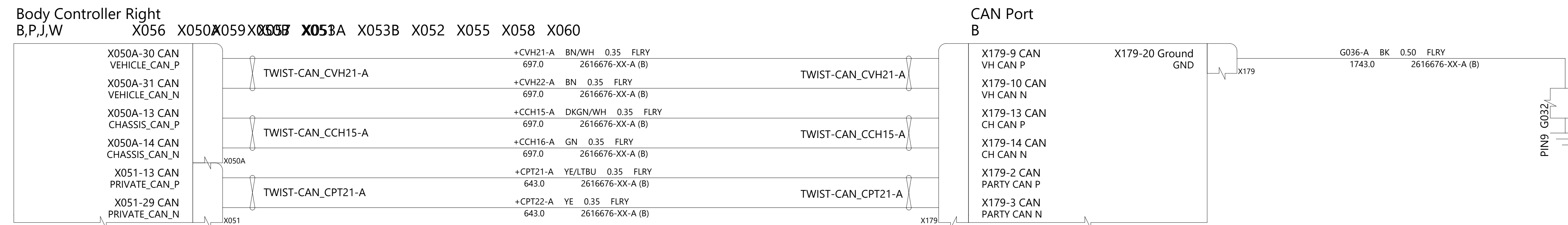

TESLA

THE INFORMATION CONTAINED HEREIN IS DEEMED TO BE CONFIDENTIAL, PROPRIETARY, AND A TRADE SECRET OF TESLA MOTORS. THIS INFORMATION MAY NOT BE USED, REPRODUCED, OR DISCLOSED AS THE DIRECT OR INDIRECT BASIS FOR THE DEVELOPMENT, MANUFACTURE, OR SALE OF PROCESSES OR PRODUCTS WITHOUT THE EXPRESSED WRITTEN CONSENT OF TESLA MOTORS.

DRAWN	CHECKED	APPROVED

MATERIAL	FINISHING	SCALE
AS SPECIFIED	AS SPECIFIED	NONE

PART NAME
Diagnostics

PART NUMBER	REV	SHEET	SIZE
	1	12 of 55	A0

Body Controller Left
A,D,J,W X036 X030A X030B X031 X039

X033A-35 Half-Bridge WINDOW_LIFT_FRONT_UP
X033A-34 Half-Bridge WINDOW_LIFT_FRONT_DOWN
X033A-24 Ground WINDOW_LIFT_FRONT_ENCODER_GROUND_RETURN
X033A-1 Signal In WINDOW_LIFT_FRONT_ENCODER_A

X033A-13 High-Side Drive DOOR_FRONT_LATCH_OPEN_PUDDLE_LED
X033A-17 Signal In DOOR_FRONT_LATCH_ENDSTOP_SWITCH
X033B-6 Half-Bridge DOOR_FRONT_LATCH_RELEASE
X033B-3 Half-Bridge DOOR_FRONT_LATCH_RESET

X033A-22 Signal In WINDOW_SWITCHPACK_FL
X033A-19 Signal In WINDOW_SWITCHPACK_RR
X033A-20 Signal In WINDOW_SWITCHPACK_RL
X033A-21 Signal In WINDOW_SWITCHPACK_FR
X033A-11 High-Side Drive DOOR_FRONT_WINDOW_SWITCH_LED

X033A-4 Signal In DOOR_FRONT_INTERIOR_HANDLE_SWITCH
X033A-12 High-Side Drive DOOR_FRONT_INTERIOR_HANDLE_SWITCH_LED

X033A-6 Signal In DOOR_FRONT_EXTERIOR_HANDLE_SENSOR
X033A-5 High-Side Drive DOOR_FRONT_EXTERIOR_HANDLE_SENSOR_SV

X033A-8 Half-Bridge MIRROR_TILT_UP_DOWN
X033A-9 Half-Bridge MIRROR_TILT_COMMON
X033A-7 Half-Bridge MIRROR_TILT_LEFT_RIGHT
X033B-1 High-Side Drive MIRROR_HEAT
X033B-2 High-Side Drive MIRROR_DIM
X033A-10 Half-Bridge MIRROR_FOLD
X033A-23 Half-Bridge MIRROR_UNFOLD
X033A-18 High-Side Drive MIRROR_TILT_POSITION_SV
X033A-3 Signal In MIRROR_TILT_POSITION_UP_DOWN
X033A-2 Signal In MIRROR_TILT_POSITION_LEFT_RIGHT
X033B-4 PWM Out LC_MIRROR_LEFT_DIM_A
X033B-5 PWM Out LC_MIRROR_LEFT_DIM_B

X033B-8 High-Side Drive DOOR_FRONT_MAP_POCKET_LED
X033A-33 Ground SHARED_DOOR_GROUND_RETURN

X037 X033A X033B X032 X035 X038

DCLO1-A RD 1.50 FLYR
2807.0 1616678-XX-B (D)

DCLO2-A TN 1.50 FLYR
2807.0 1616678-XX-B (D)

DCL12-A BK 0.35 FLYR
2807.0 1616678-XX-B (D)

DCL13-A GN 0.35 FLYR
2807.0 1616678-XX-B (D)

DCL21-A VT 0.35 FLYR
3016.0 1616678-XX-B (D)

DCL22-A BN 0.35 FLYR
1752.0 1616678-XX-B (D)

DCL23-A WH 0.50 FLYR
1840.0 1616678-XX-B (D)

DCL24-A GY 0.50 FLYR
1840.0 1616678-XX-B (D)

DCL31-A GN 0.35 FLYR
LHD 3528.0 1616678-XX-B (D)

DCL32-A VT 0.35 FLYR
LHD 3528.0 1616678-XX-B (D)

DCL33-A BN 0.35 FLYR
LHD 3528.0 1616678-XX-B (D)

DCL34-A YE 0.35 FLYR
LHD 3528.0 1616678-XX-B (D)

DCL35-A GY 0.35 FLYR
LHD 3528.0 1616678-XX-B (D)

DCL31-B GN 0.35 FLYR
RHD 3528.0 1616678-XX-B (D)

DCL35-B GY 0.35 FLYR
RHD 3528.0 1616678-XX-B (D)

DCL41-A WH 0.35 FLYR
3318.0 1616678-XX-B (D)

DCL42-A YE 0.35 FLYR
3318.0 1616678-XX-B (D)

DCL43-A BU 0.35 FLYR
1924.0 1616678-XX-B (D)

DCL44-A TN 0.35 FLYR
1924.0 1616678-XX-B (D)

DCL51-B VT 0.35 FLYR
LCDIM 2758.0 1616678-XX-B (D)

DCL52-B YE 0.35 FLYR
LCDIM 2758.0 1616678-XX-B (D)

DCL53-B WH 0.35 FLYR
LCDIM 2758.0 1616678-XX-B (D)

DCL55-B RD 0.35 FLYR
LCDIM 2758.0 1616678-XX-B (D)

DCL56-B BN 0.35 FLYR
LCDIM 2758.0 1616678-XX-B (D)

DCL58-B GN 0.35 FLYR
LCDIM 2758.0 1616678-XX-B (D)

DCL59-B BU 0.35 FLYR
LCDIM 2758.0 1616678-XX-B (D)

DCL60-B RD 0.35 FLYR
LCDIM 2758.0 1616678-XX-B (D)

DCL61-B VT 0.35 FLYR
LCDIM 2758.0 1616678-XX-B (D)

DCL62-B GY 0.35 FLYR
LCDIM 2758.0 1616678-XX-B (D)

DCL63-A VT 0.35 FLYR
LCDIM 2758.0 1616678-XX-B (D)

DCL64-A BU 0.35 FLYR
LCDIM 2758.0 1616678-XX-B (D)

DCL71-A RD 0.35 FLYR
3603.0 1616678-XX-B (D)

DCL80-G BK 1.00 FLYR
2384.0 1616678-XX-B (D)

Puddle LED Front Left
D

X371-1 Power In
X371-2 Ground

DCL22-A BN 0.35 FLYR
1752.0 1616678-XX-B (D)

DCL23-A WH 0.50 FLYR
1840.0 1616678-XX-B (D)

DCL24-A GY 0.50 FLYR
1840.0 1616678-XX-B (D)

DCL31-A GN 0.35 FLYR
LHD 3528.0 1616678-XX-B (D)

DCL32-A VT 0.35 FLYR
LHD 3528.0 1616678-XX-B (D)

DCL33-A BN 0.35 FLYR
LHD 3528.0 1616678-XX-B (D)

DCL34-A YE 0.35 FLYR
LHD 3528.0 1616678-XX-B (D)

DCL35-A GY 0.35 FLYR
LHD 3528.0 1616678-XX-B (D)

DCL31-B GN 0.35 FLYR
RHD 3528.0 1616678-XX-B (D)

DCL35-B GY 0.35 FLYR
RHD 3528.0 1616678-XX-B (D)

DCL41-A WH 0.35 FLYR
3318.0 1616678-XX-B (D)

DCL42-A YE 0.35 FLYR
3318.0 1616678-XX-B (D)

DCL43-A BU 0.35 FLYR
1924.0 1616678-XX-B (D)

DCL44-A TN 0.35 FLYR
1924.0 1616678-XX-B (D)

DCL51-B VT 0.35 FLYR
LCDIM 2758.0 1616678-XX-B (D)

DCL52-B YE 0.35 FLYR
LCDIM 2758.0 1616678-XX-B (D)

DCL53-B WH 0.35 FLYR
LCDIM 2758.0 1616678-XX-B (D)

DCL55-B RD 0.35 FLYR
LCDIM 2758.0 1616678-XX-B (D)

DCL56-B BN 0.35 FLYR
LCDIM 2758.0 1616678-XX-B (D)

DCL58-B GN 0.35 FLYR
LCDIM 2758.0 1616678-XX-B (D)

DCL59-B BU 0.35 FLYR
LCDIM 2758.0 1616678-XX-B (D)

DCL60-B RD 0.35 FLYR
LCDIM 2758.0 1616678-XX-B (D)

DCL61-B VT 0.35 FLYR
LCDIM 2758.0 1616678-XX-B (D)

DCL62-B GY 0.35 FLYR
LCDIM 2758.0 1616678-XX-B (D)

DCL63-A VT 0.35 FLYR
LCDIM 2758.0 1616678-XX-B (D)

DCL64-A BU 0.35 FLYR
LCDIM 2758.0 1616678-XX-B (D)

DCL71-A RD 0.35 FLYR
3603.0 1616678-XX-B (D)

DCL80-G BK 1.00 FLYR
2384.0 1616678-XX-B (D)

Window Lift Motor Front Left
D

X373-1 Motor B(+)
X373-3 Motor B(-)
X373-6 Ground Hall IC GND
X373-4 Hall Sensor Out Hall Signal 1

Latch Front Left
D

X380-8 Signal Out AJAR/OPEN
X380-1 Signal Out UNLATCH_CAM_POSITION
X380-4 Motor UNLATCH_OPEN
X380-3 Motor UNLATCH_RESET

LHD Window Switch Driver Front Left
D

X365-1 Analog Out Front Left Window
X365-4 Analog Out Rear Right Window
X365-3 Analog Out Rear Left Window
X365-2 Analog Out Front Right Window
X365-5 Power In Illumination

RHD Window Switch Pass Front Left
D

X369-2 Analog Out Switch
X369-1 Power In LED

Interior Open Switch Front Left
D

X366-3 Digital Out Switch
X366-2 PWM In Illumination

Exterior Open Switch Front Left
D

X367-2 Analog Out Signal
X367-4 Power In Sensor Power

LCDIM Mirror Left Premium, EC/LC
D

X376A-9 Motor Motor Tilt (Up+, Down-)
X376A-8 Motor Motor Common
X376A-3 Motor Motor Pan (Left-, Right+)
X376A-1 Power In Heater (+)
X376A-14 Power In EC (+)
X376A-2 Motor Fold (+), Unfold (-)
X376A-10 Motor Fold (-), Unfold (+)
X376A-4 Power In Position Vref 5V
X376A-5 Analog Out Position Vertical (Tilt)
X376A-12 Analog Out Position Horizontal (Pan)
X376A-11 PWM In LC (+)
X376A-13 PWM In LC (-)

Door Map Pocket LED Front Left
D

X370-1 Power In
X370-2 Ground

DCL80-B BK 0.50 FLYR
LCDIM 384.0 1616678-XX-B (D)

DCL80-X BK 0.35 FLYR
1616678-XX-B (D)



THE INFORMATION CONTAINED HEREIN IS DEEMED TO BE CONFIDENTIAL, PROPRIETARY, AND A TRADE SECRET OF TESLA MOTORS. THIS INFORMATION MAY NOT BE USED, REPRODUCED, OR DISCLOSED AS THE DIRECT OR INDIRECT BASIS FOR THE DEVELOPMENT, MANUFACTURE, OR SALE OF PROCESSES OR PRODUCTS WITHOUT THE EXPRESSED WRITTEN CONSENT OF TESLA MOTORS.

DRAWN	CHECKED	APPROVED
MATERIAL AS SPECIFIED	FINISHING AS SPECIFIED	SCALE NONE
PART NAME Door Front Left		
PART NUMBER	REV 1	SHEET 13 OF 55
		SIZE A0

Body Controller Right
B,P,J,W X053A X050B X051 X059 X057 X053A X053B X052 X055 X058 X060



THE INFORMATION CONTAINED HEREIN IS DEEMED TO BE CONFIDENTIAL, PROPRIETARY, AND A TRADE SECRET OF TESLA MOTORS. THIS INFORMATION MAY NOT BE USED, REPRODUCED, OR DISCLOSED AS THE DIRECT OR INDIRECT BASIS FOR THE DEVELOPMENT, MANUFACTURE, OR SALE OF PROCESSES OR PRODUCTS WITHOUT THE EXPRESSED WRITTEN CONSENT OF TESLA MOTORS.

DRAWN	CHECKED	APPROVED
MATERIAL AS SPECIFIED	FINISHING AS SPECIFIED	SCALE NONE
PART NAME Door Front Right		
PART NUMBER	REV 1	SHEET 14 OF 55
		SIZE A0

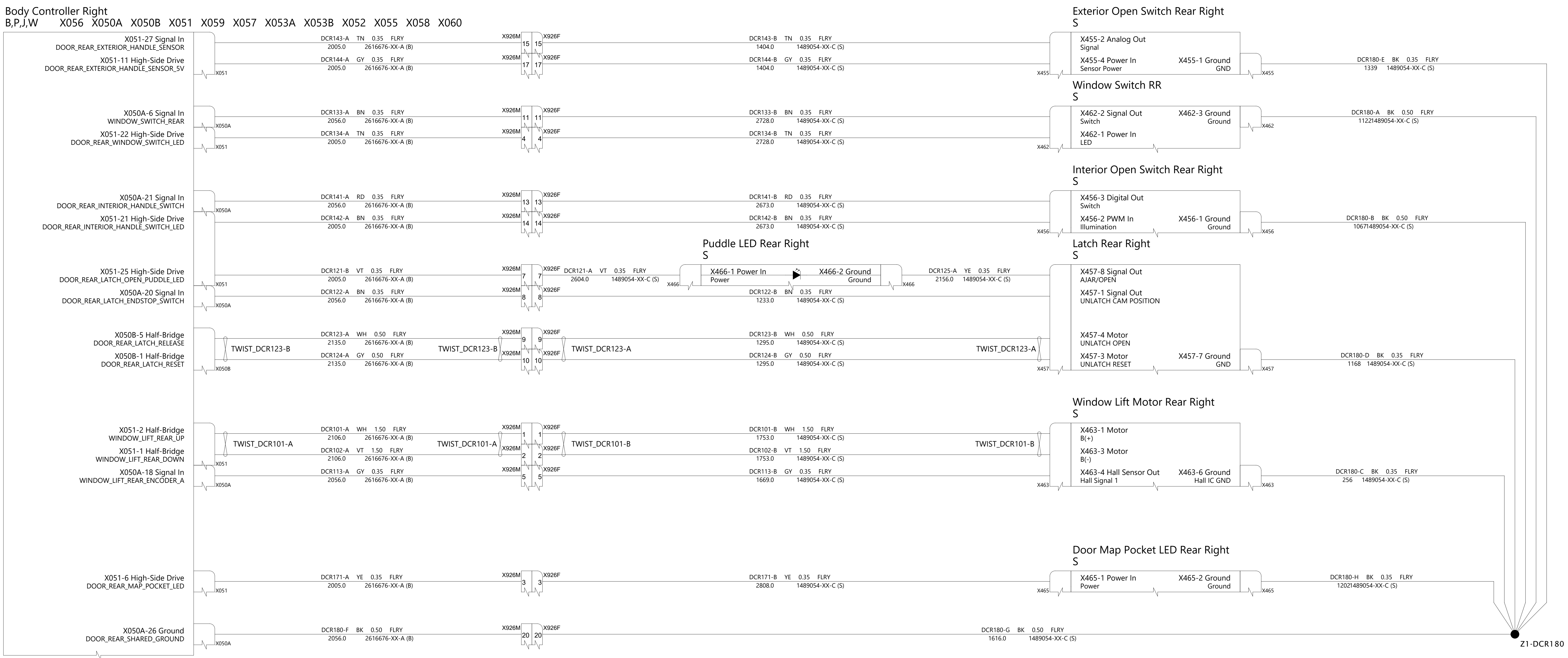
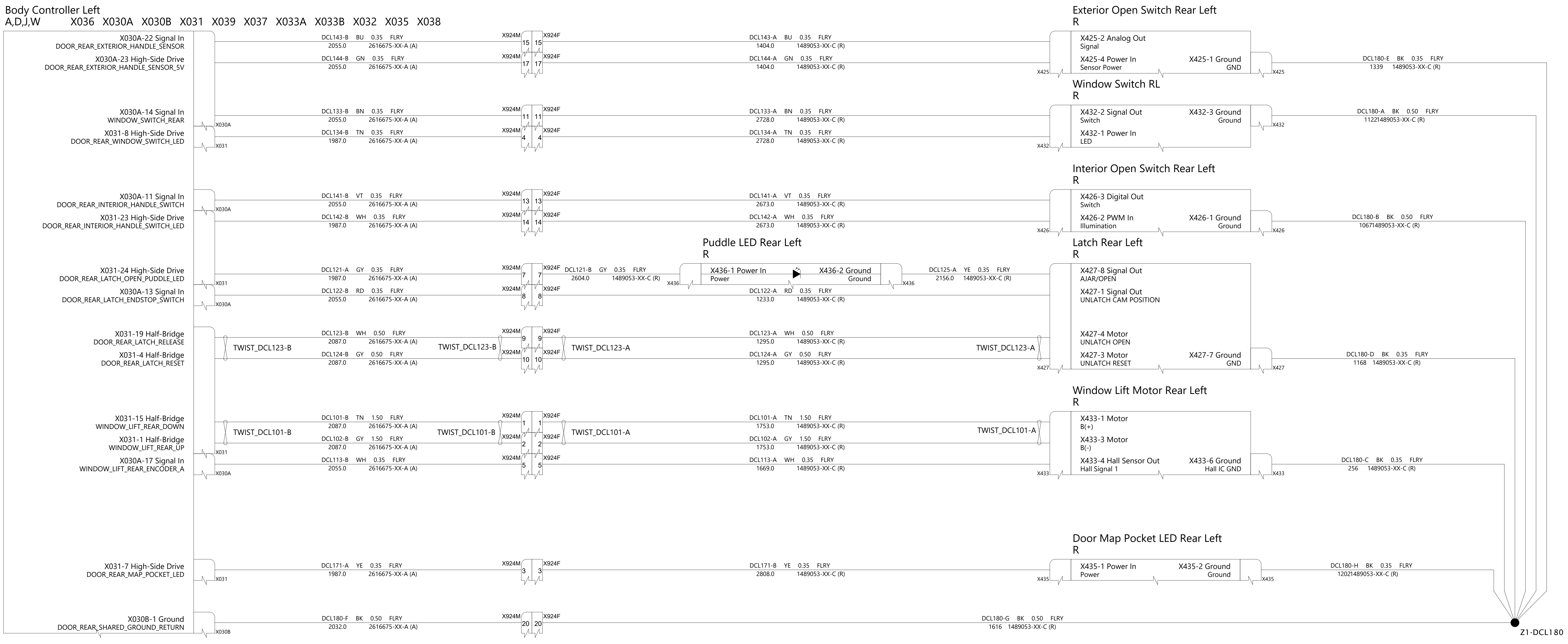

TESLA			
THE INFORMATION CONTAINED HEREIN IS DEEMED TO BE CONFIDENTIAL, PROPRIETARY, AND A TRADE SECRET OF TESLA MOTORS. THIS INFORMATION MAY NOT BE USED, REPRODUCED, OR DISCLOSED AS THE DIRECT OR INDIRECT BASIS FOR THE DEVELOPMENT, MANUFACTURE, OR SALE OF PROCESSES OR PRODUCTS WITHOUT THE EXPRESSED WRITTEN CONSENT OF TESLA MOTORS.			
DRAWN	CHECKED	APPROVED	
MATERIAL AS SPECIFIED		FINISHING AS SPECIFIED	
SCALE NONE		PART NAME Doors Rear	
PART NUMBER	REV	SHEET	SIZE
	1	15 of 55	A0

Body Controller Front
W,U X021 X012 X011 X010 X015 X014

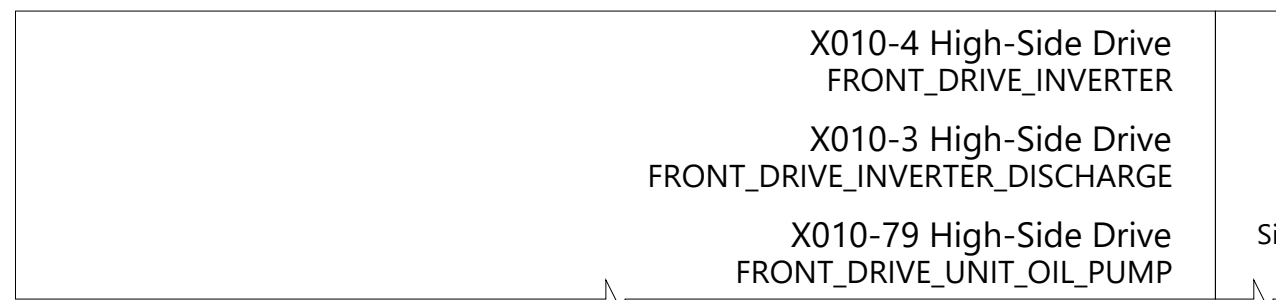

AWD Drive Inverter Front & Resolver
N X093 X094

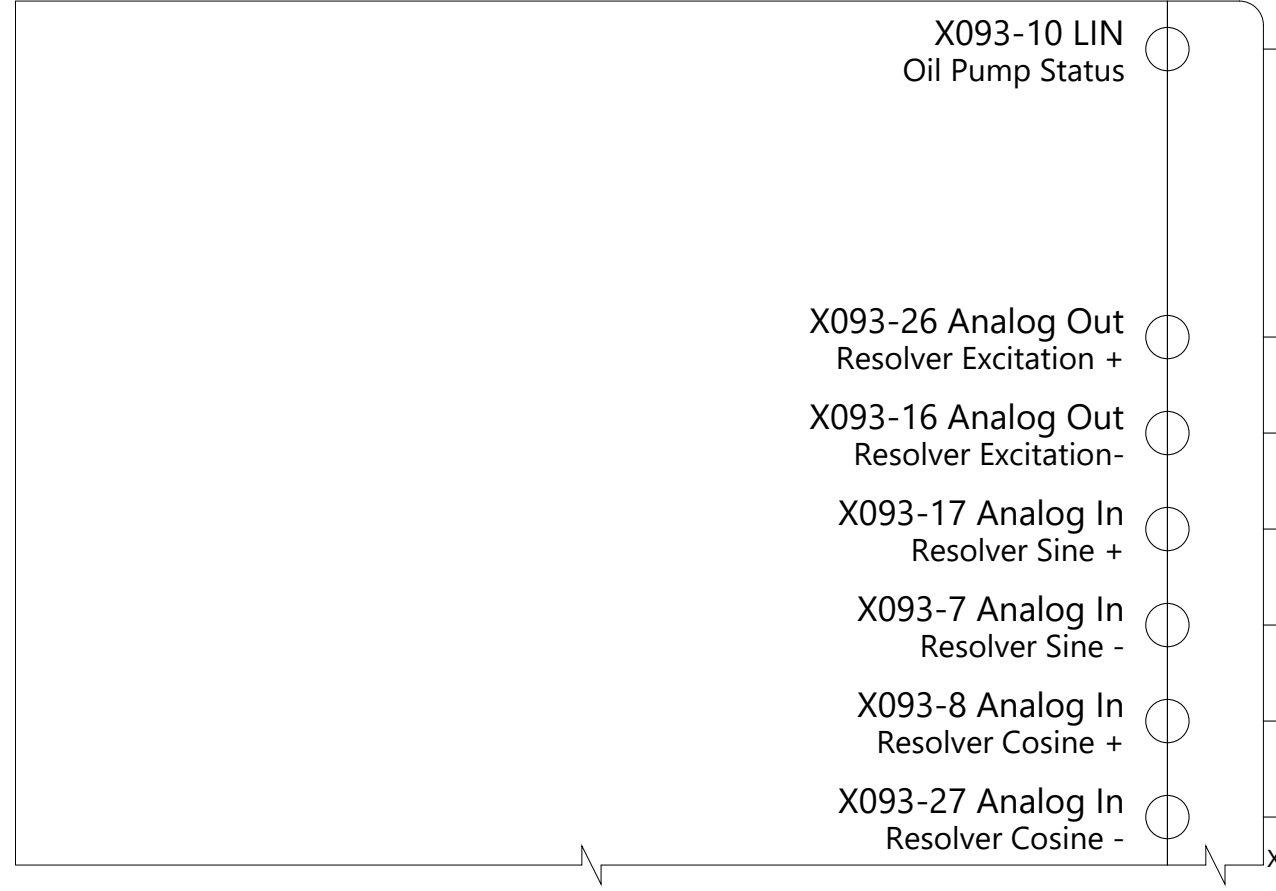

Drive Inverter Rear & Resolver
X X090 X091

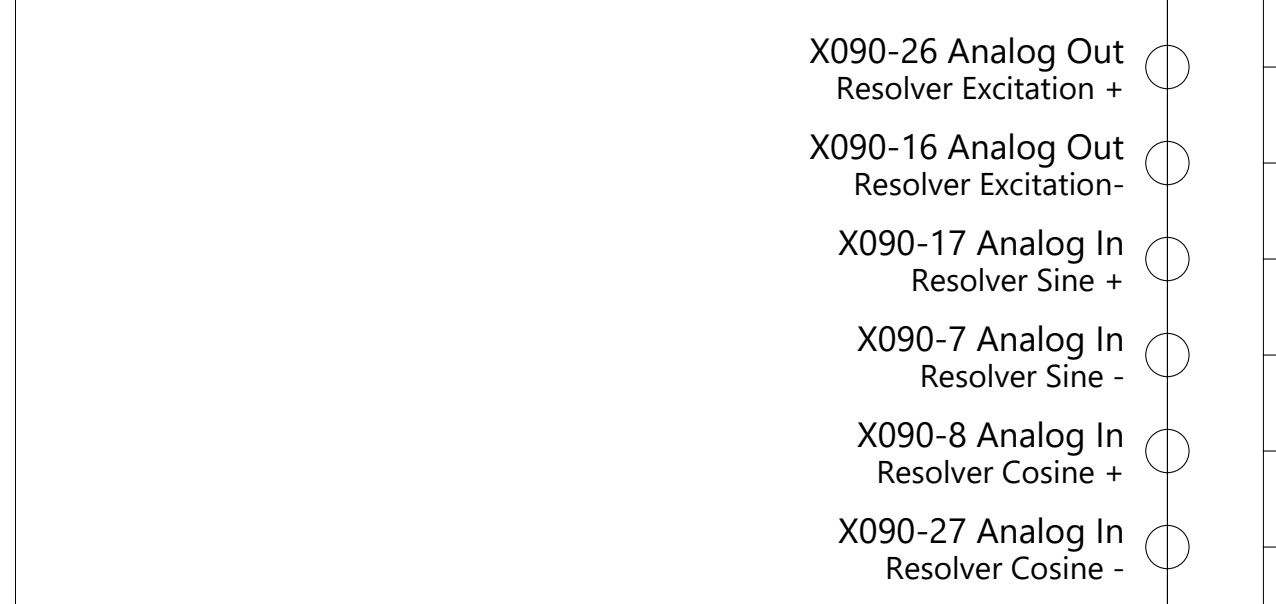
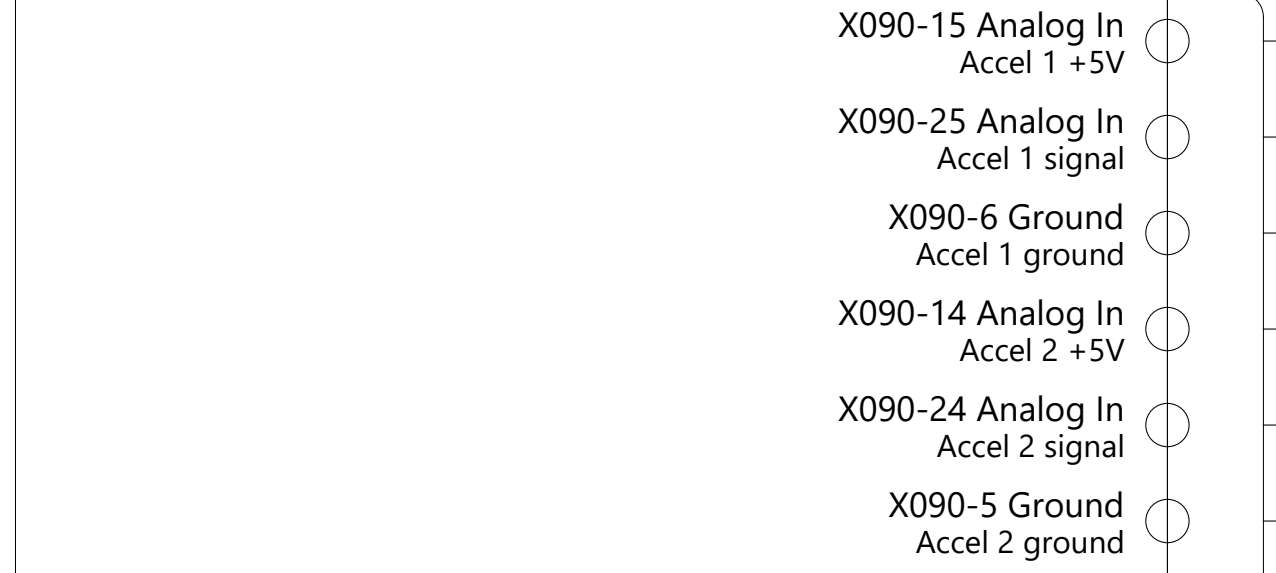

Body Controller Right
B,P,J,W X056 X050A X050B X051 X059 X057 X053A X053B X052 X055 X058 X060

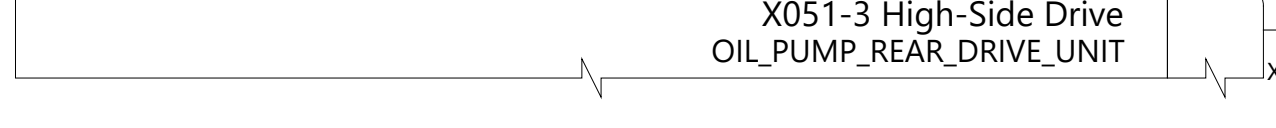

Body Controller Left
A,D,J,W X036 X030A X030B X031 X039 X037 X033A X033B X032 X035 X038

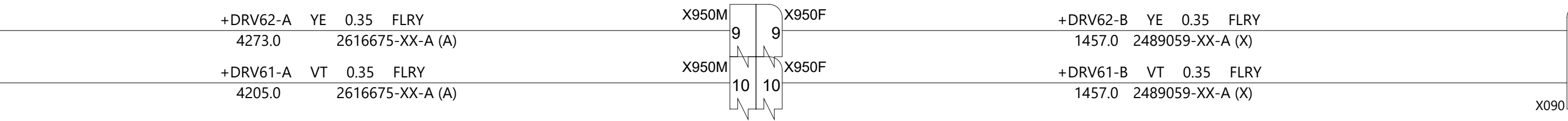
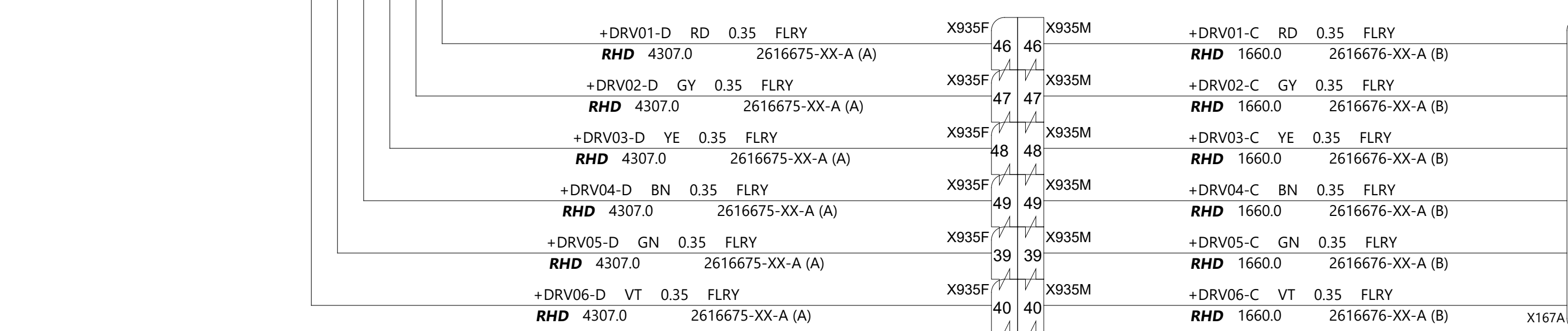
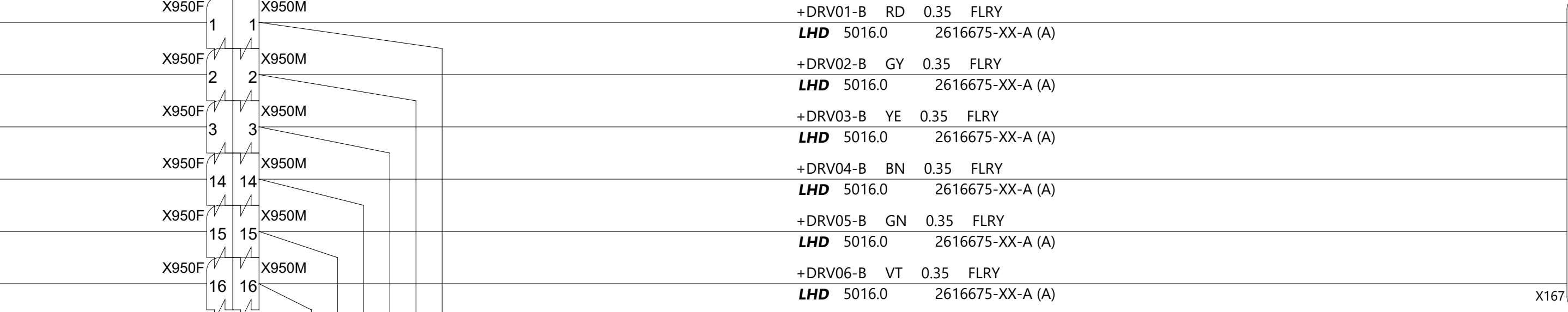
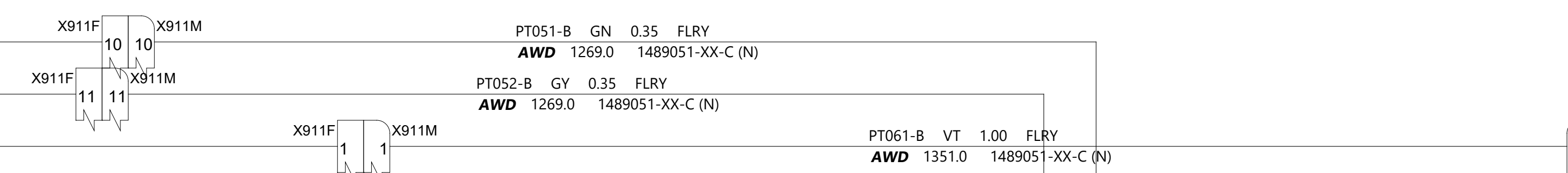
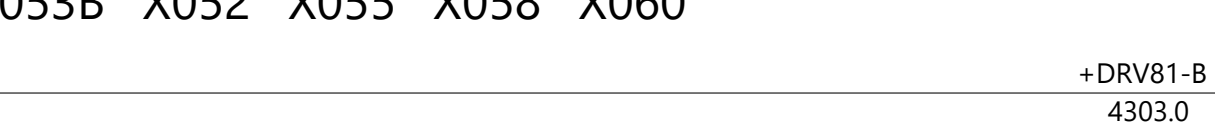

AWD Drive Unit Oil Pump Front
N

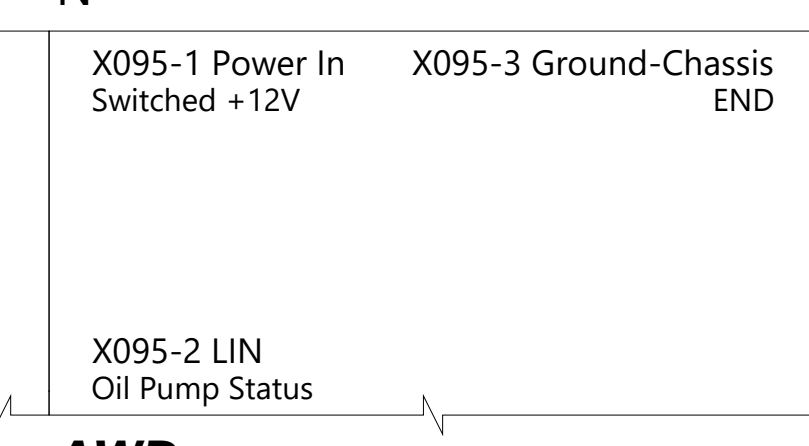

AWD Drive Inverter Front & Resolver
N X093 X094

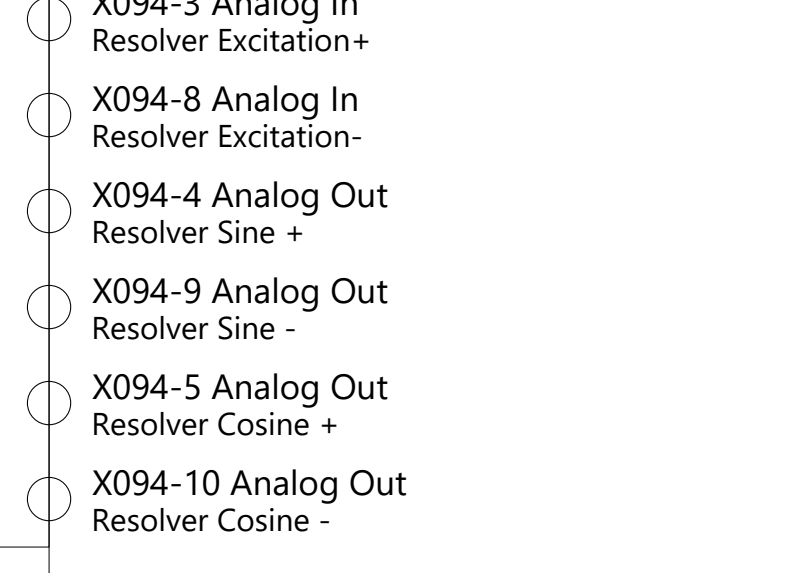

LHD Accel Pedal Sensor (LHD)
A

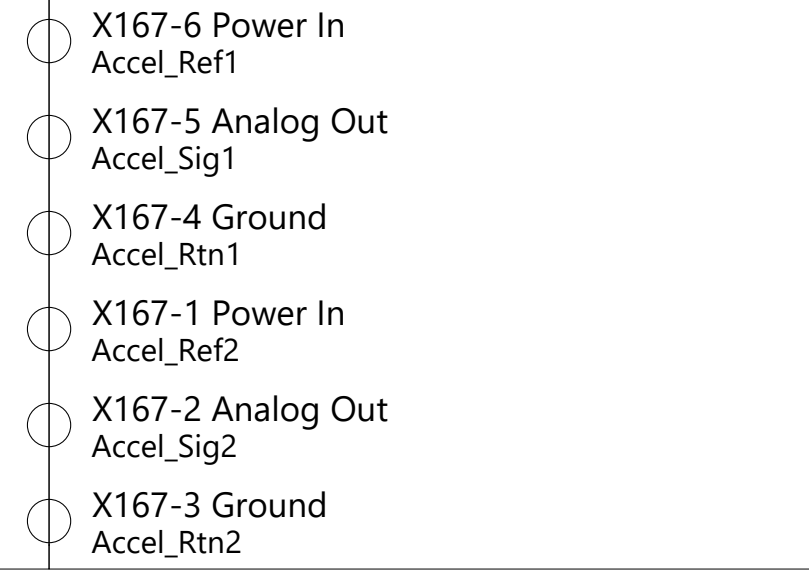

RHD Accel Pedal Sensor (RHD)
B

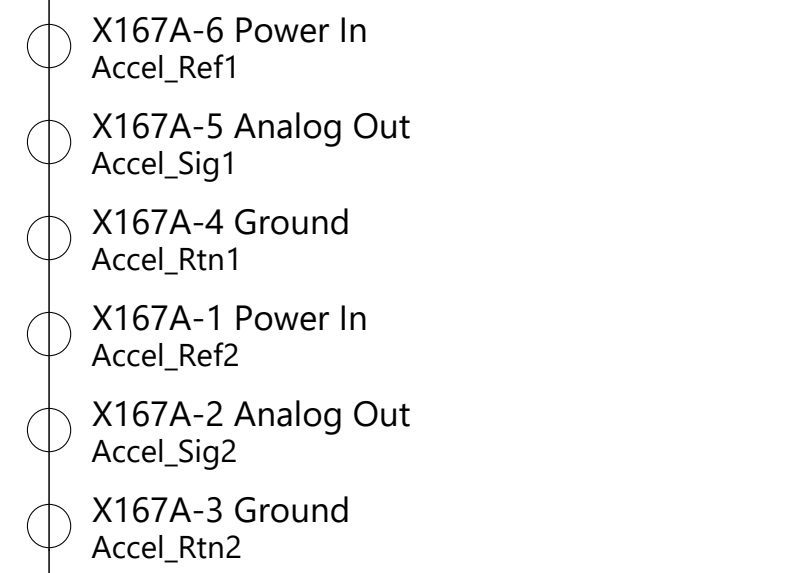

Drive Inverter Rear & Resolver
X X090 X091

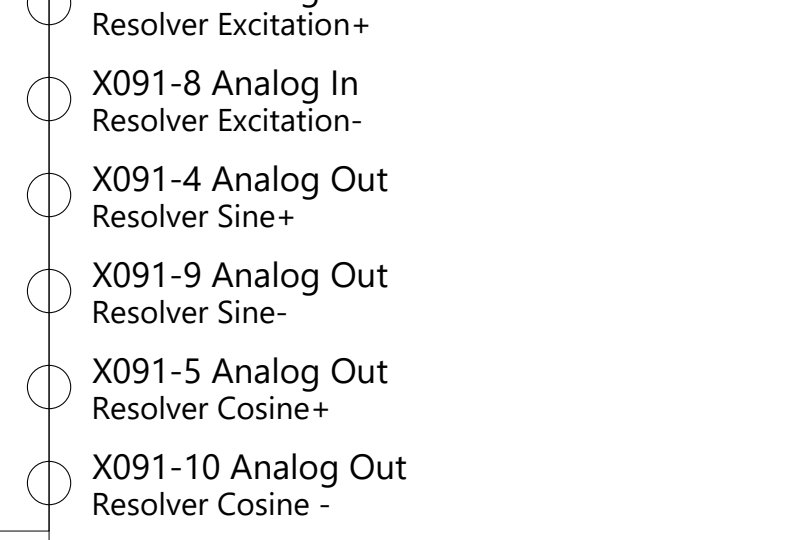

Drive Unit Oil Pump Rear
X

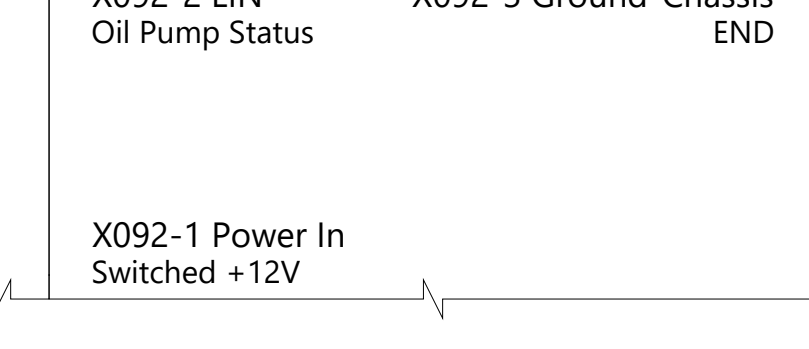

THE INFORMATION CONTAINED HEREIN IS DEEMED TO BE CONFIDENTIAL, PROPRIETARY, AND A TRADE SECRET OF TESLA MOTORS. THIS INFORMATION MAY NOT BE USED, REPRODUCED, OR DISCLOSED AS THE DIRECT OR INDIRECT BASIS FOR THE DEVELOPMENT, MANUFACTURE, OR SALE OF PROCESSES OR PRODUCTS WITHOUT THE EXPRESSED WRITTEN CONSENT OF TESLA MOTORS.

DRAWN	CHECKED	APPROVED
MATERIAL AS SPECIFIED	FINISHING AS SPECIFIED	SCALE NONE
PART NAME Drive Inverters		
PART NUMBER	REV	SHEET
	1	16 of 55
		A0

Body Controller Front
W,U X021 X012 X011 X010 X015 X014

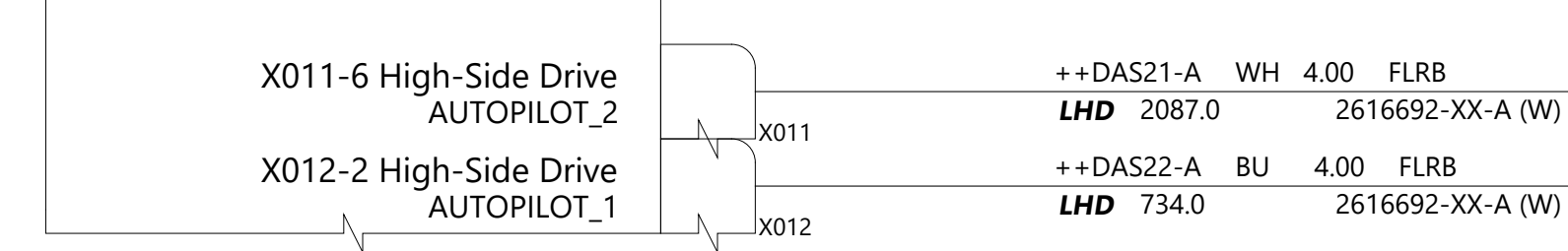

LHD
Autopilot ECU (LHD)
W,J,B

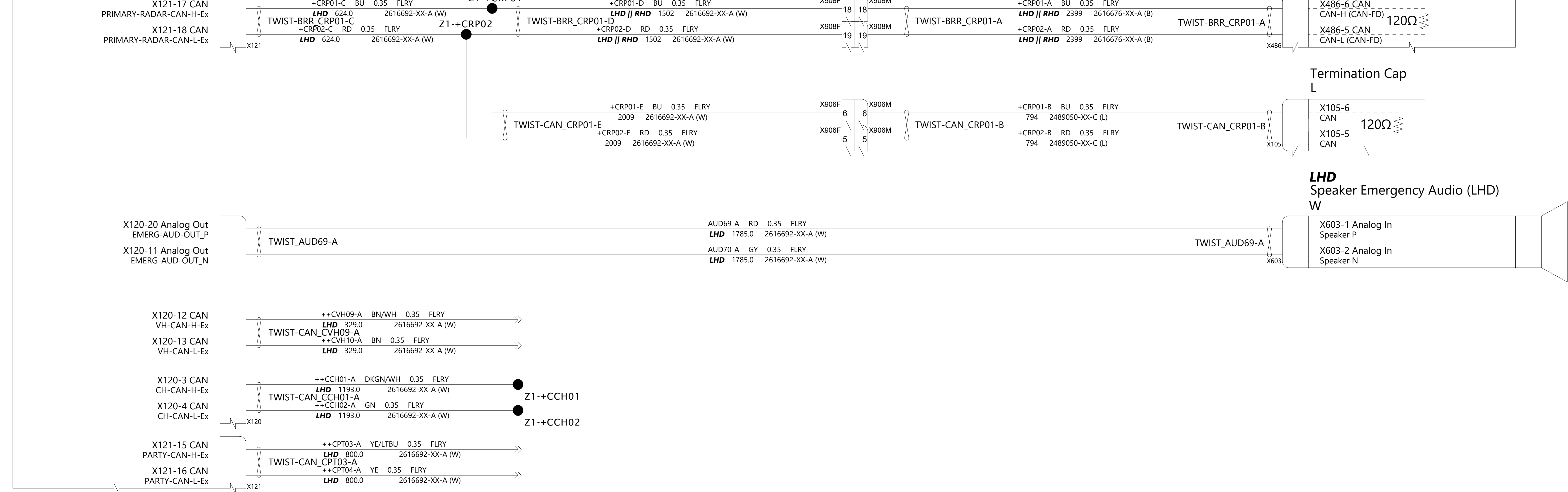
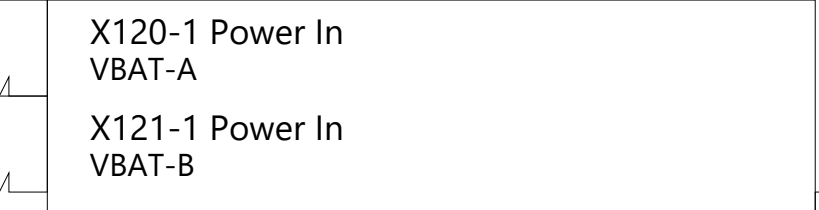

Grounded through enclosure and +G999 wire

TESLA

THE INFORMATION CONTAINED HEREIN IS DEEMED TO BE CONFIDENTIAL, PROPRIETARY, AND A TRADE SECRET OF TESLA MOTORS. THIS INFORMATION MAY NOT BE USED, REPRODUCED, OR DISCLOSED AS THE DIRECT OR INDIRECT BASIS FOR THE DEVELOPMENT, MANUFACTURE, OR SALE OF PROCESSES OR PRODUCTS WITHOUT THE EXPRESSED WRITTEN CONSENT OF TESLA MOTORS.

DRAWN	CHECKED	APPROVED
-------	---------	----------

MATERIAL AS SPECIFIED	FINISHING AS SPECIFIED	SCALE NONE
--------------------------	---------------------------	---------------

PART NAME
Driver Assistance

PART NUMBER	REV	SHEET	SIZE
	1	17 OF 55	A0

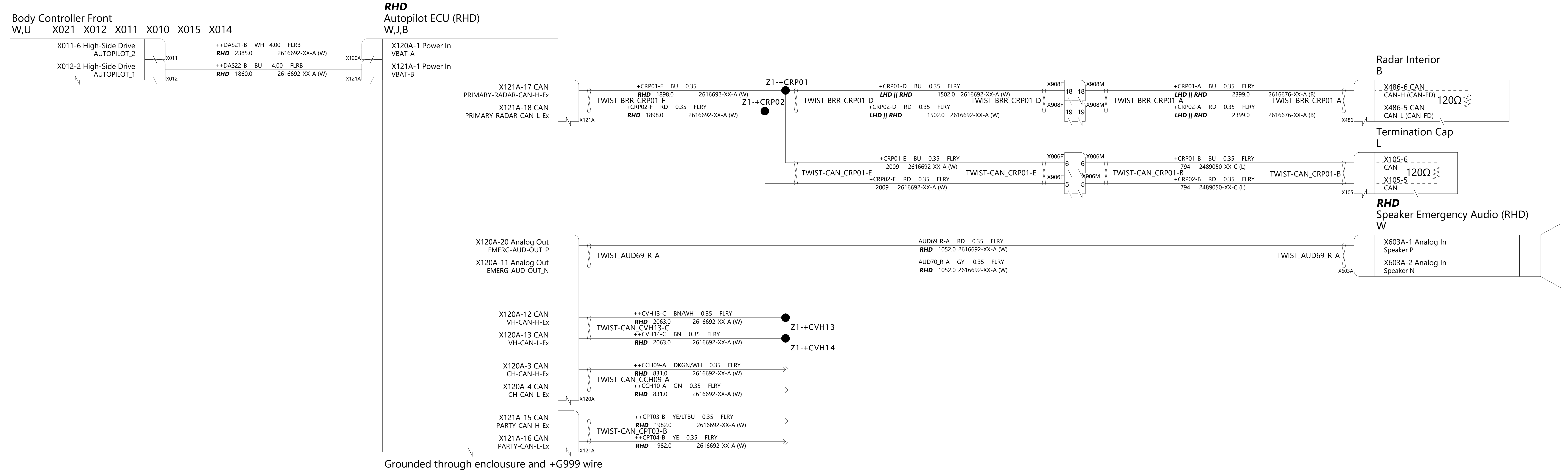

TESLA

THE INFORMATION CONTAINED HEREIN IS DEEMED TO BE CONFIDENTIAL, PROPRIETARY, AND A TRADE SECRET OF TESLA MOTORS. THIS INFORMATION MAY NOT BE USED, REPRODUCED, OR DISCLOSED AS THE DIRECT OR INDIRECT BASIS FOR THE DEVELOPMENT, MANUFACTURE, OR SALE OF PROCESSES OR PRODUCTS WITHOUT THE EXPRESSED WRITTEN CONSENT OF TESLA MOTORS.

DRAWN	CHECKED	APPROVED
-------	---------	----------

MATERIAL AS SPECIFIED	FINISHING AS SPECIFIED	SCALE NONE
--------------------------	---------------------------	---------------

PART NAME
Driver Assistance, RHD

PART NUMBER	REV	SHEET	SIZE
	1	18 OF 55	A0

Body Controller Front
W,U X021 X012 X011 X010 X015 X014

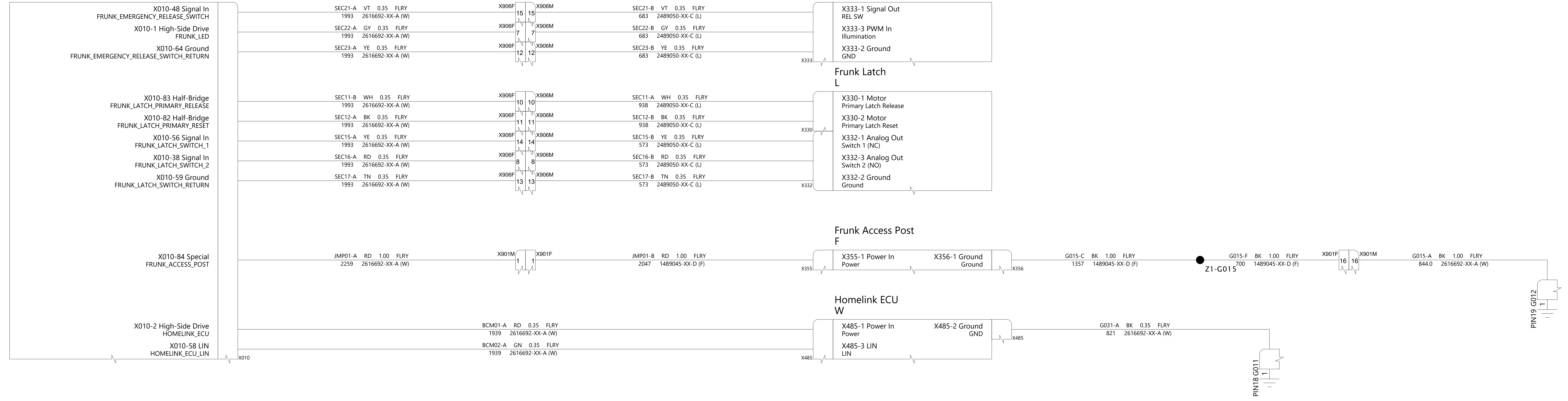

THE INFORMATION CONTAINED HEREIN IS DEEMED TO BE CONFIDENTIAL, PROPRIETARY, AND A TRADE SECRET OF TESLA MOTORS. THIS INFORMATION MAY NOT BE USED, REPRODUCED, OR DISCLOSED AS THE DIRECT OR INDIRECT BASIS FOR THE DEVELOPMENT, MANUFACTURE, OR SALE OF PROCESSES OR PRODUCTS WITHOUT THE EXPRESSED WRITTEN CONSENT OF TESLA MOTORS.

DRAWN	CHECKED	APPROVED

MATERIAL AS SPECIFIED	FINISHING AS SPECIFIED	SCALE NONE
--------------------------	---------------------------	---------------

PART NAME
Frunk Actuator/Sensors

PART NUMBER	REV	SHEET	SIZE
	1	19 of 55	A0

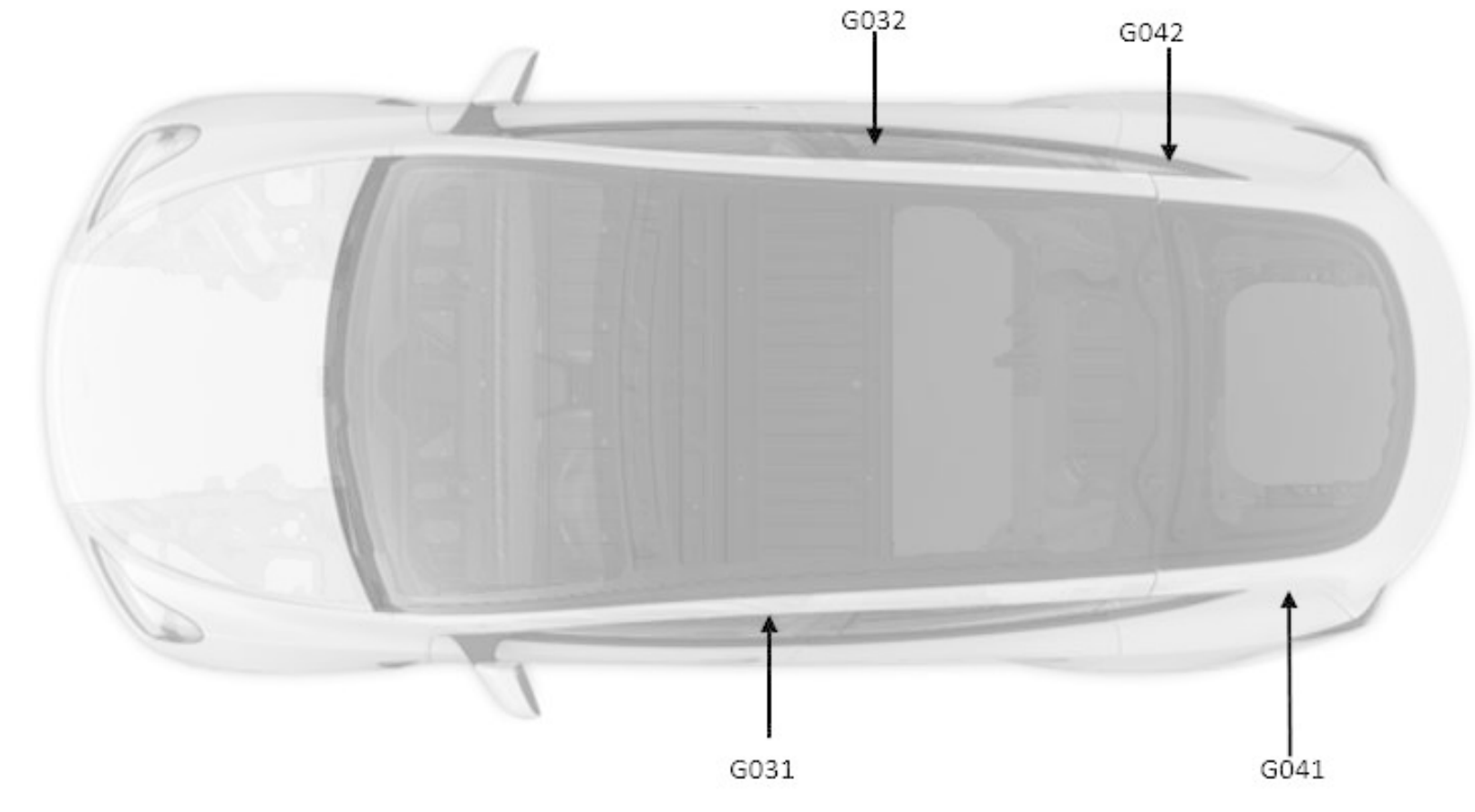
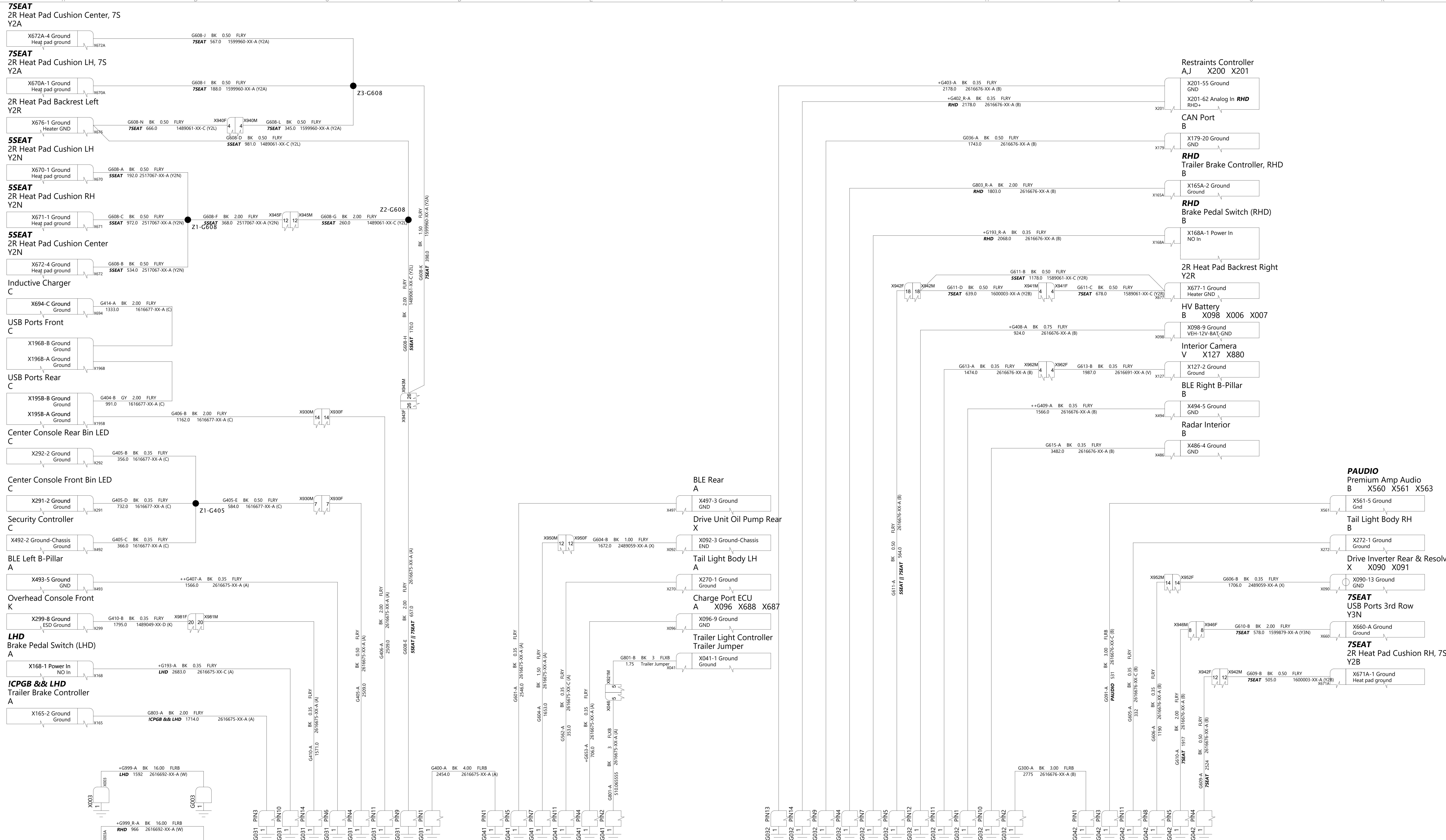

TESLA			
THE INFORMATION CONTAINED HEREIN IS DEEMED TO BE CONFIDENTIAL, PROPRIETARY, AND A TRADE SECRET OF TESLA MOTORS. THIS INFORMATION MAY NOT BE USED, REPRODUCED, OR DISCLOSED AS THE DIRECT OR INDIRECT BASIS FOR THE DEVELOPMENT, MANUFACTURE, OR SALE OF PROCESSES OR PRODUCTS WITHOUT THE EXPRESS WRITTEN CONSENT OF TESLA MOTORS.			
DRAWN	CHECKED	APPROVED	
MATERIAL AS SPECIFIED		FINISHING AS SPECIFIED	SCALE NONE
PART NAME Grounding - Cabin			
PART NUMBER	REV	SHEET	SIZE
	1	20 OF 55	A0

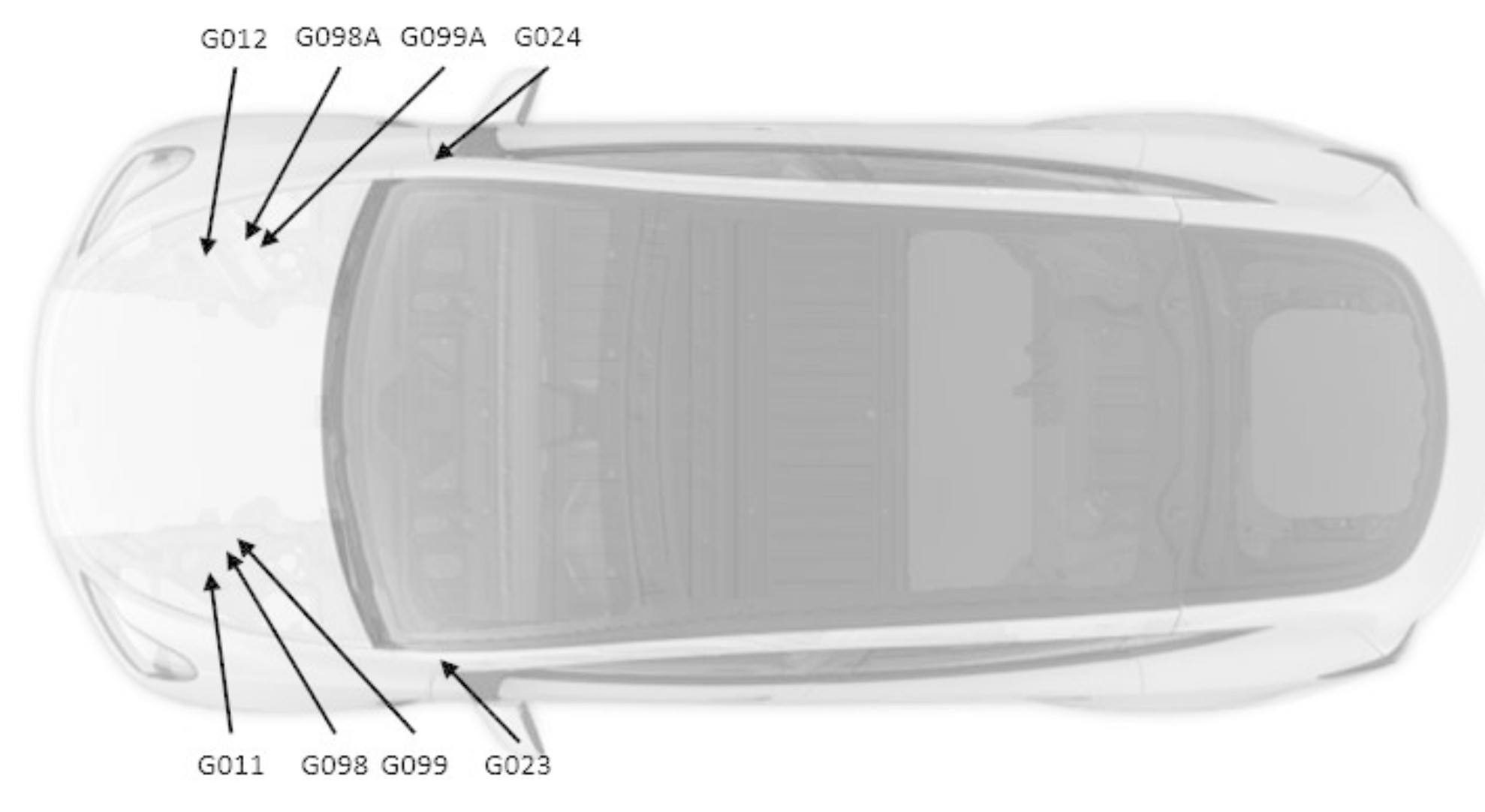
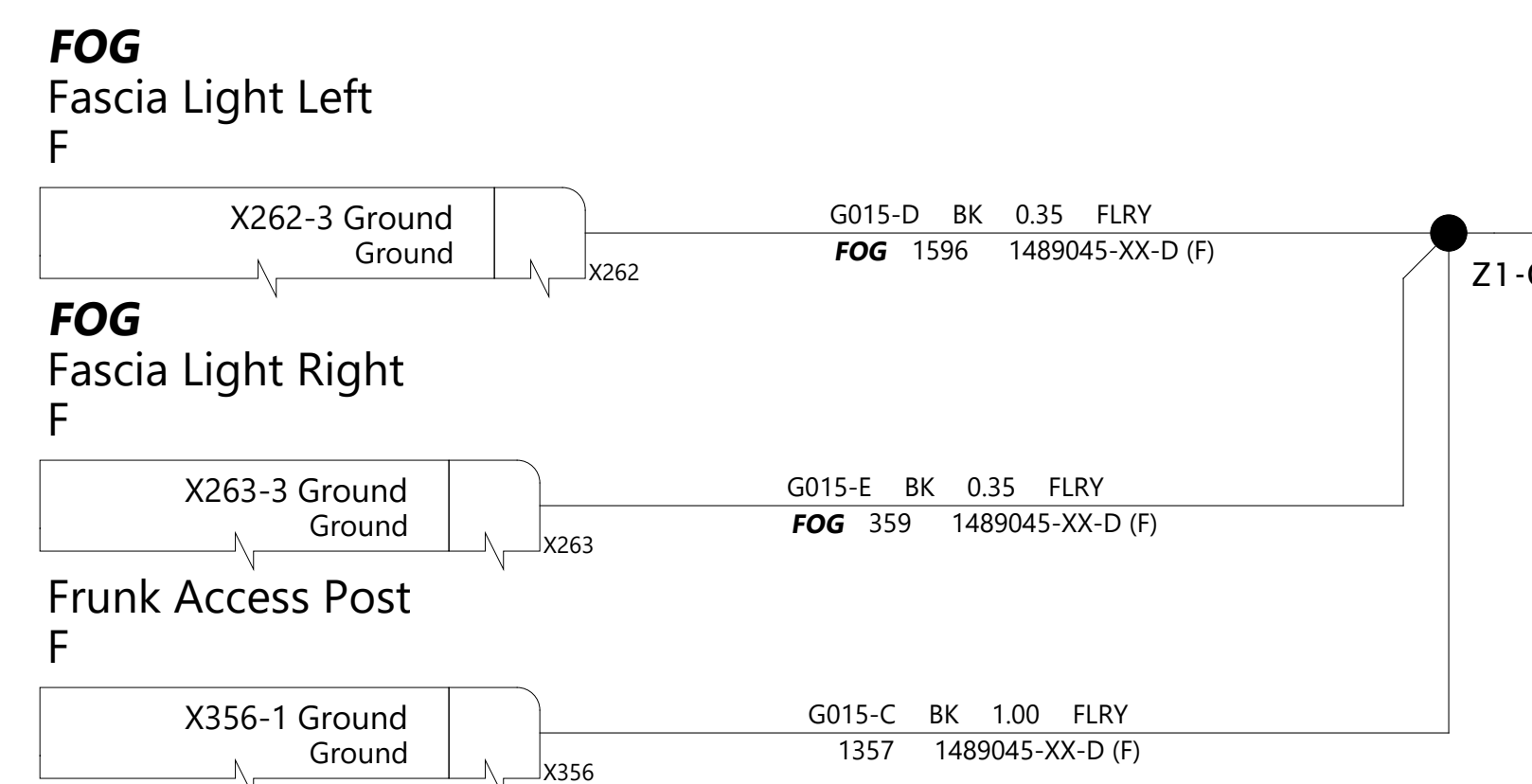
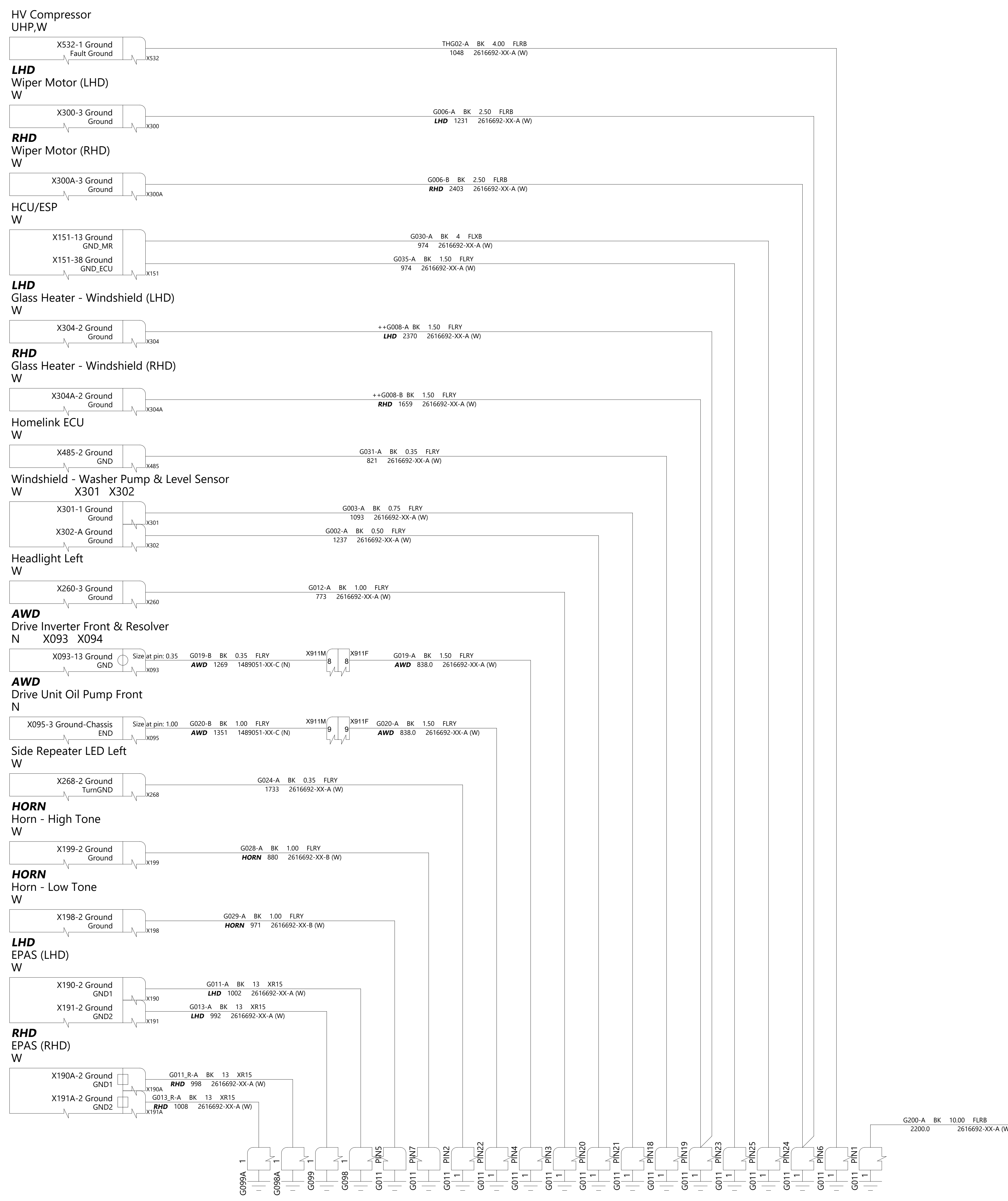

TESLA			
THE INFORMATION CONTAINED HEREIN IS DEEMED TO BE CONFIDENTIAL, PROPRIETARY, AND A TRADE SECRET OF TESLA MOTORS. THIS INFORMATION MAY NOT BE USED, REPRODUCED, OR DISCLOSED AS THE DIRECT OR INDIRECT BASIS FOR THE DEVELOPMENT, MANUFACTURE, OR SALE OF PROCESSES OR PRODUCTS WITHOUT THE EXPRESSED WRITTEN CONSENT OF TESLA MOTORS.			
DRAWN	CHECKED	APPROVED	
MATERIAL AS SPECIFIED		FINISHING AS SPECIFIED	SCALE NONE
PART NAME Grounding - Frunk			
PART NUMBER	REV	SHEET	SIZE
	1	21 OF 55	A0

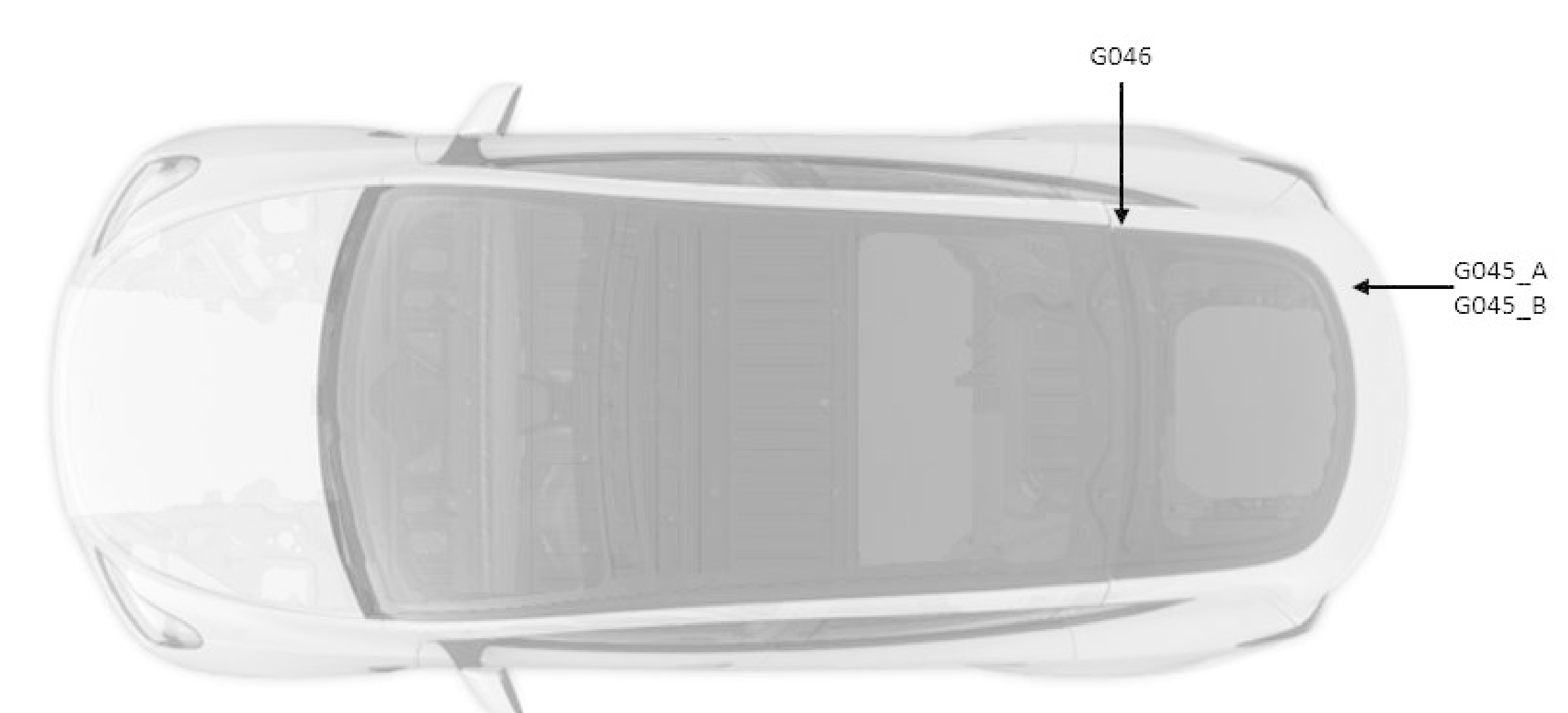
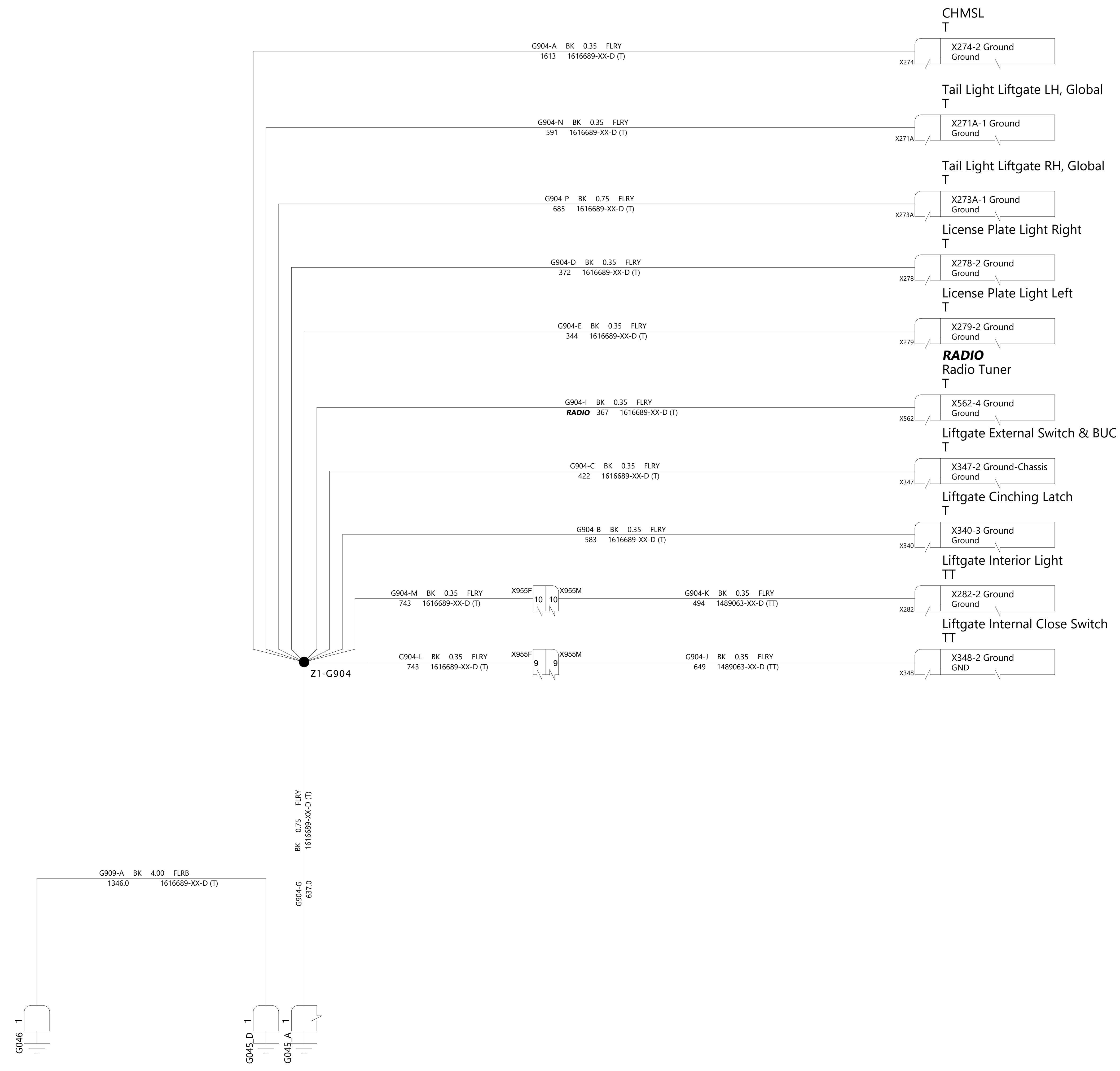

TESLA			
THE INFORMATION CONTAINED HEREIN IS DEEMED TO BE CONFIDENTIAL, PROPRIETARY, AND A TRADE SECRET OF TESLA MOTORS. THIS INFORMATION MAY NOT BE USED, REPRODUCED, OR DISCLOSED AS THE DIRECT OR INDIRECT BASIS FOR THE DEVELOPMENT, MANUFACTURE, OR SALE OF PROCESSES OR PRODUCTS WITHOUT THE EXPRESSED WRITTEN CONSENT OF TESLA MOTORS.			
DRAWN	CHECKED	APPROVED	
MATERIAL AS SPECIFIED		FINISHING AS SPECIFIED	SCALE NONE
PART NAME Grounding - Liftgate			
PART NUMBER	REV	SHEET	SIZE
	1	22 of 55	A0

Body Controller Left
A,D,I,W

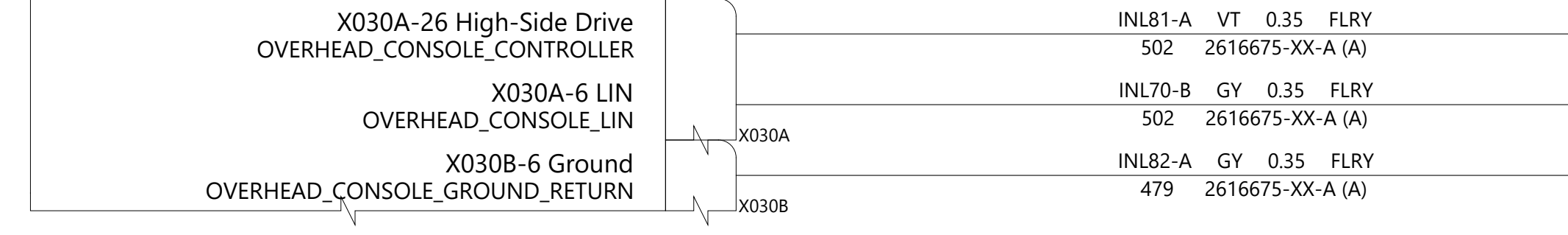

Overhead Console Front
K



Vanity LED Right
K

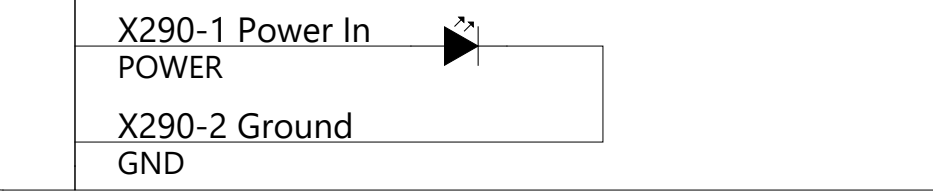

Vanity LED Left
K

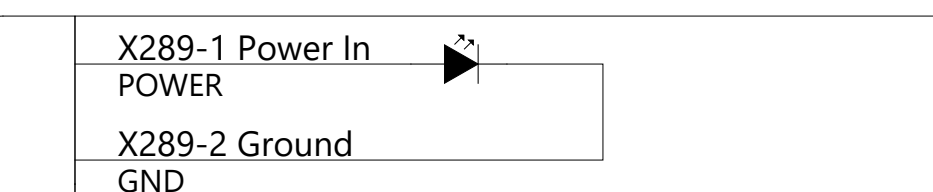

Rear Maplight RH
K

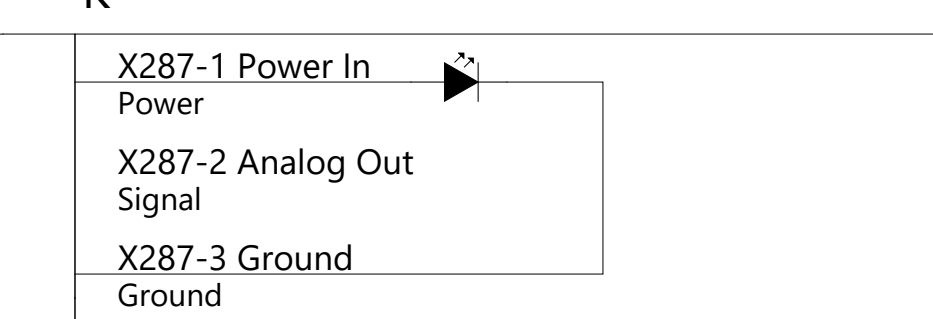

Rear Maplight LH
K

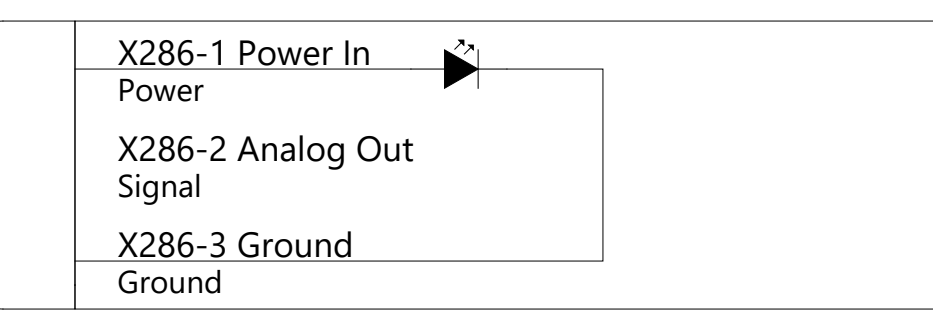

Body Controller Right
B,P,I,W

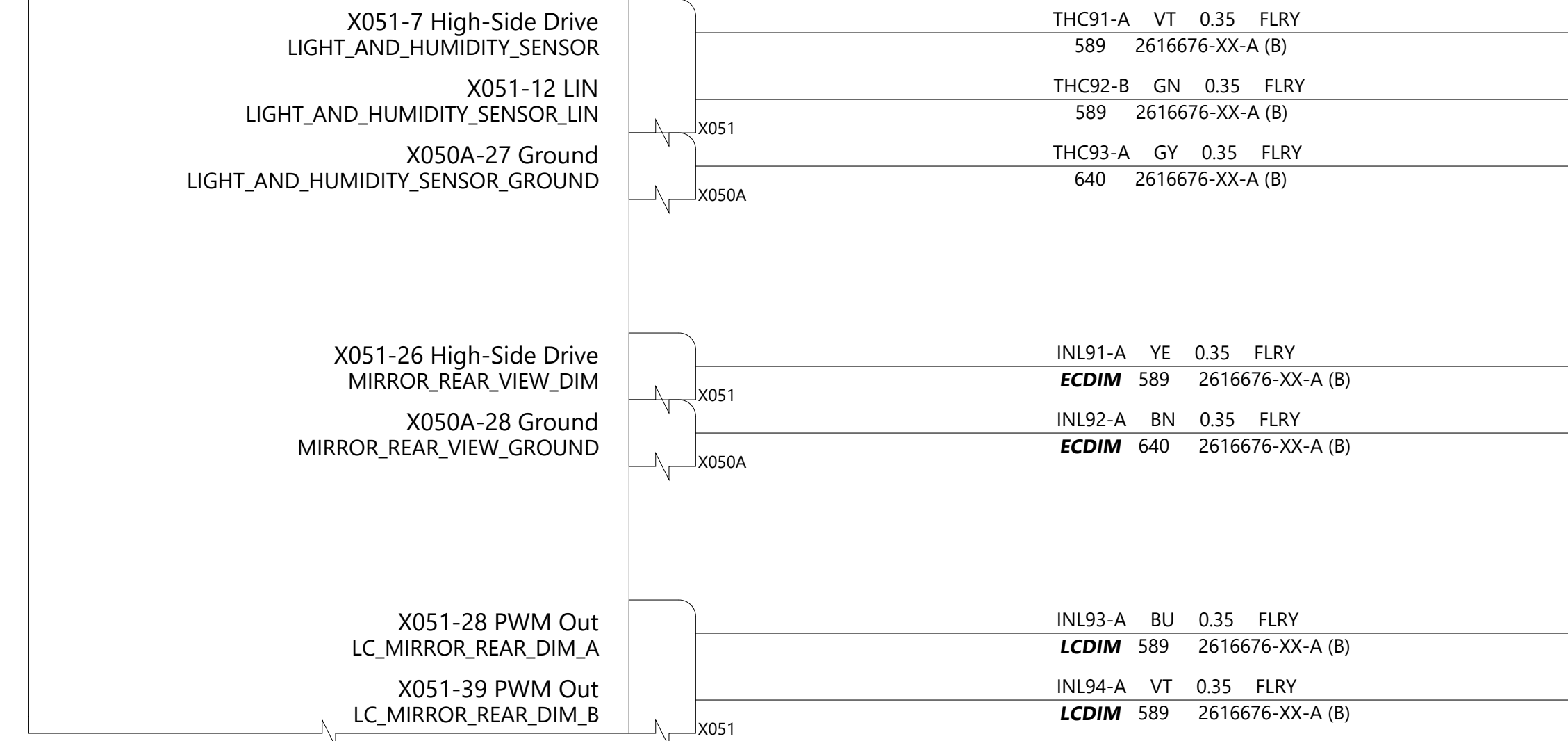

Humidity and Glass Temp
V

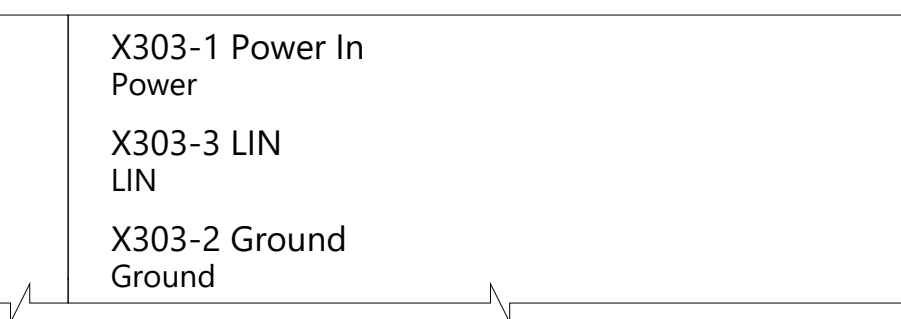

ECDIM
Mirror - Rear View - Electrochromatic
V



LCDIM
Mirror - Rear View - Liquid Crystal
V

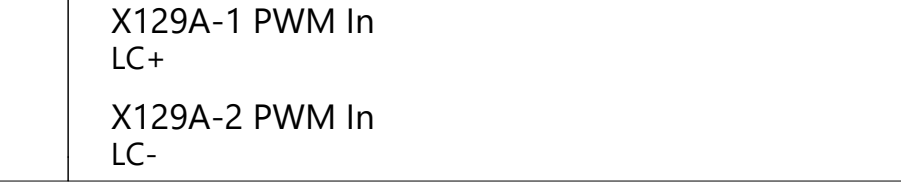

THE INFORMATION CONTAINED HEREIN IS DEEMED TO BE CONFIDENTIAL, PROPRIETARY, AND A TRADE SECRET OF TESLA MOTORS. THIS INFORMATION MAY NOT BE USED, REPRODUCED, OR DISCLOSED AS THE DIRECT OR INDIRECT BASIS FOR THE DEVELOPMENT, MANUFACTURE, OR SALE OF PROCESSES OR PRODUCTS WITHOUT THE EXPRESSED WRITTEN CONSENT OF TESLA MOTORS.

DRAWN	CHECKED	APPROVED
MATERIAL AS SPECIFIED	FINISHING AS SPECIFIED	SCALE NONE
PART NAME Headliner		
PART NUMBER	REV 1	SHEET 23 OF 55
		SIZE A0

Body Controller Left
A,D,J,W X036 X030A X030B X031 X039 X037 X033A X033B X032 X035 X038

Body Controller Right
B,P,J,W X056 X050A X050B X051 X059 X057 X053A X053B X052 X055 X058 X060

HV Battery
B X098 X006 X007

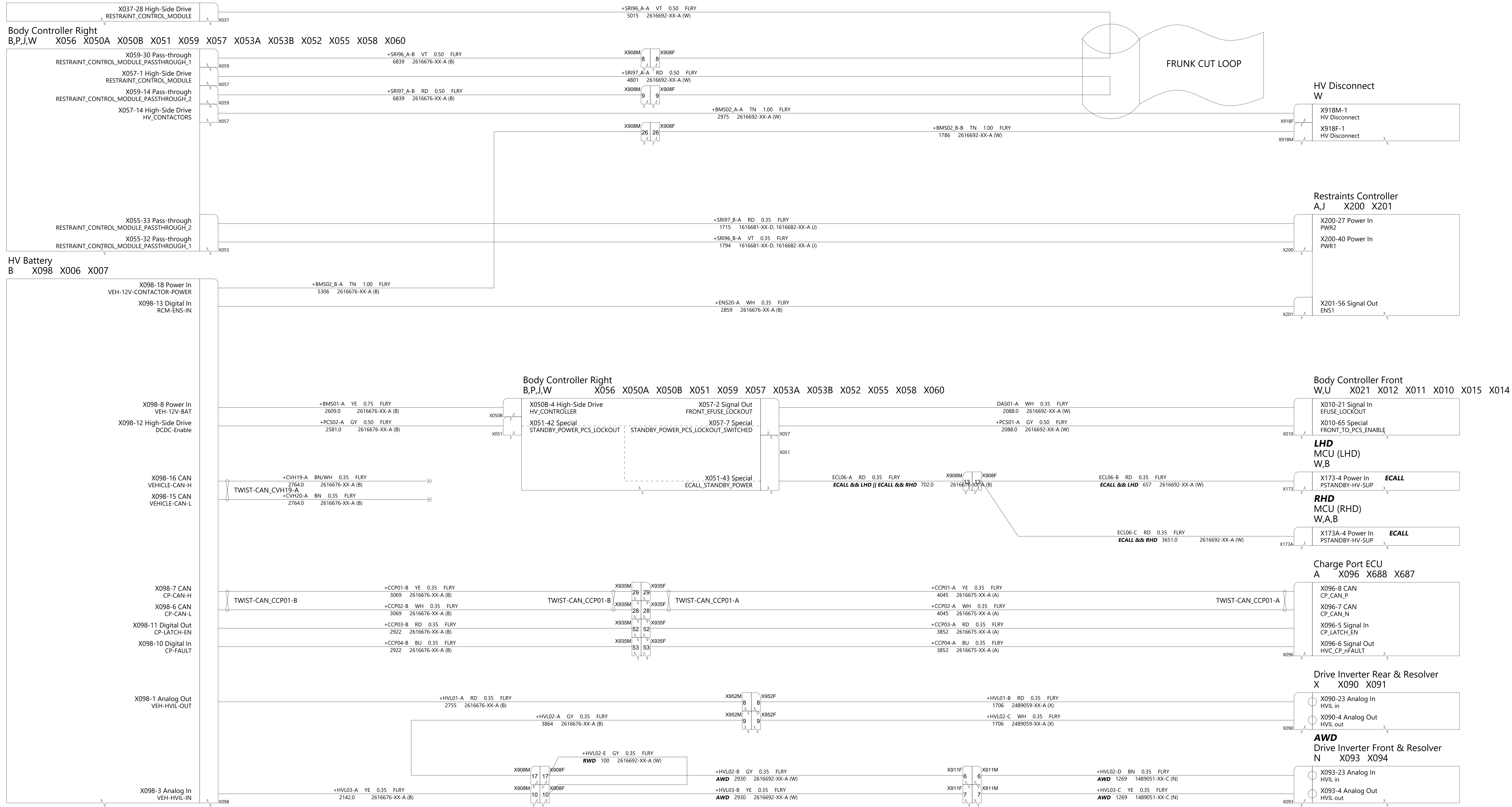

TESLA

THE INFORMATION CONTAINED HEREIN IS DEEMED TO BE CONFIDENTIAL, PROPRIETARY, AND A TRADE SECRET OF TESLA MOTORS. THIS INFORMATION MAY NOT BE USED, REPRODUCED, OR DISCLOSED AS THE DIRECT OR INDIRECT BASIS FOR THE DEVELOPMENT, MANUFACTURE, OR SALE OF PROCESSES OR PRODUCTS WITHOUT THE EXPRESSED WRITTEN CONSENT OF TESLA MOTORS.

DRAWN	CHECKED	APPROVED
MATERIAL AS SPECIFIED	FINISHING AS SPECIFIED	SCALE NONE
PART NAME HV Battery and HVIL		
PART NUMBER	REV	SHEET
	1	24 OF 55
		SCALE A0

Body Controller Right
X050A X050B X051 X059 X057 X053A X053B X052 X055 X058 X060

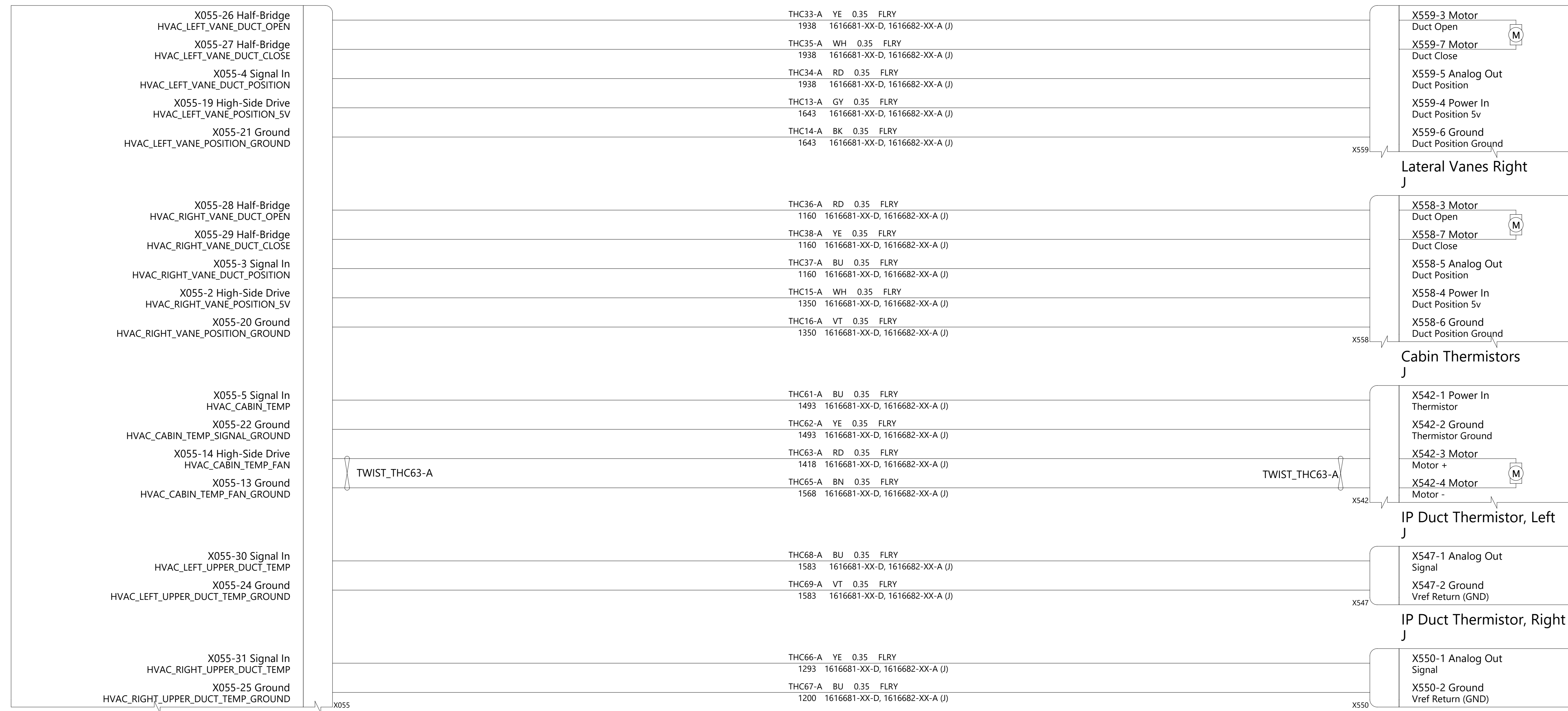

Body Controller Left
X030A X030B X031 X039 X037 X033A X033B X032 X035 X038

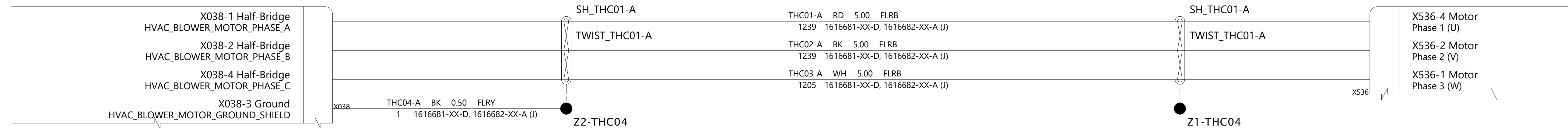

THE INFORMATION CONTAINED HEREIN IS DEEMED TO BE CONFIDENTIAL, PROPRIETARY, AND A TRADE SECRET OF TESLA MOTORS. THIS INFORMATION MAY NOT BE USED, REPRODUCED, OR DISCLOSED AS THE DIRECT OR INDIRECT BASIS FOR THE DEVELOPMENT, MANUFACTURE, OR SALE OF PROCESSES OR PRODUCTS WITHOUT THE EXPRESSED WRITTEN CONSENT OF TESLA MOTORS.

DRAWN	CHECKED	APPROVED

MATERIAL AS SPECIFIED	FINISHING AS SPECIFIED	SCALE NONE
--------------------------	---------------------------	---------------

PART NAME
HVAC - Cabin

PART NUMBER	REV	SHEET	SIZE
	1	26 of 55	A0

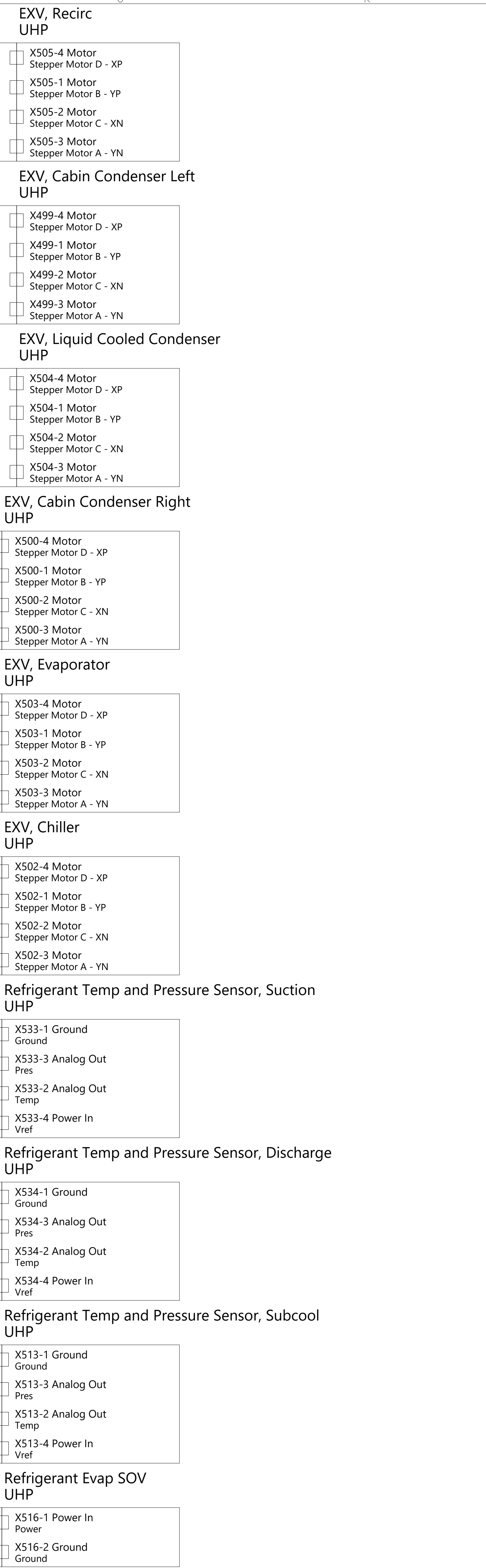
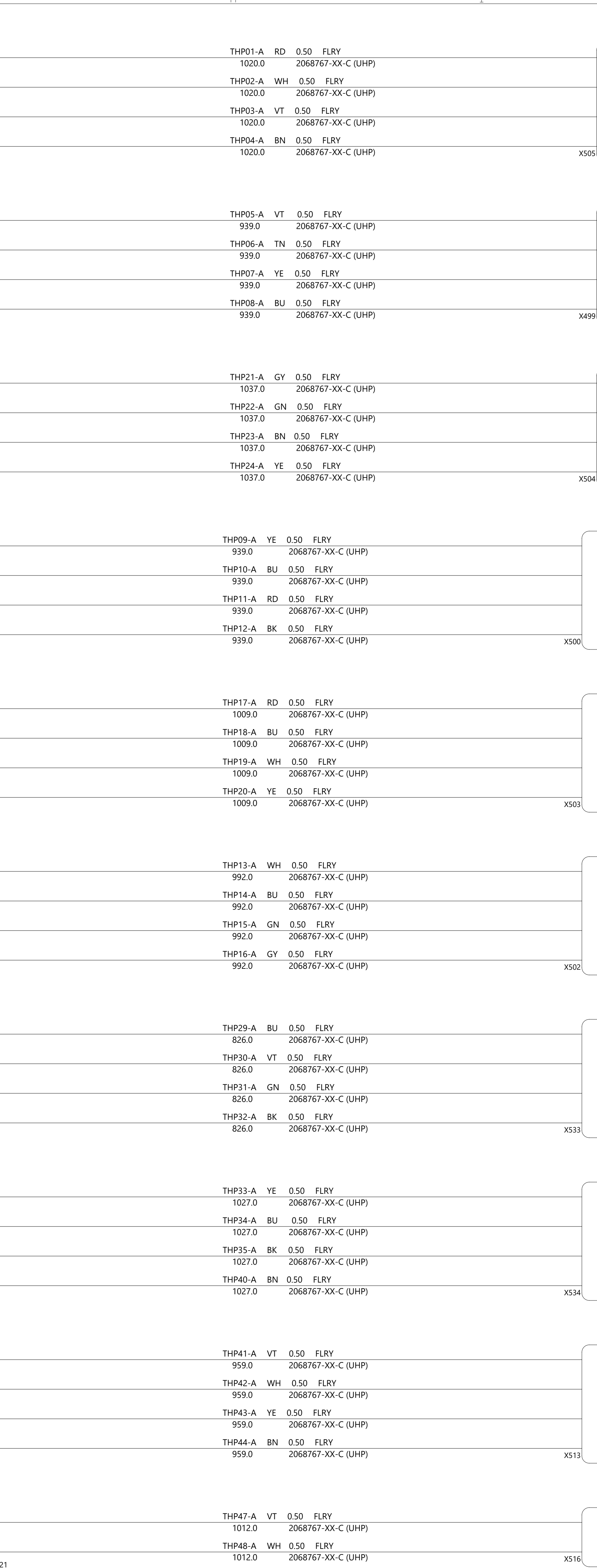
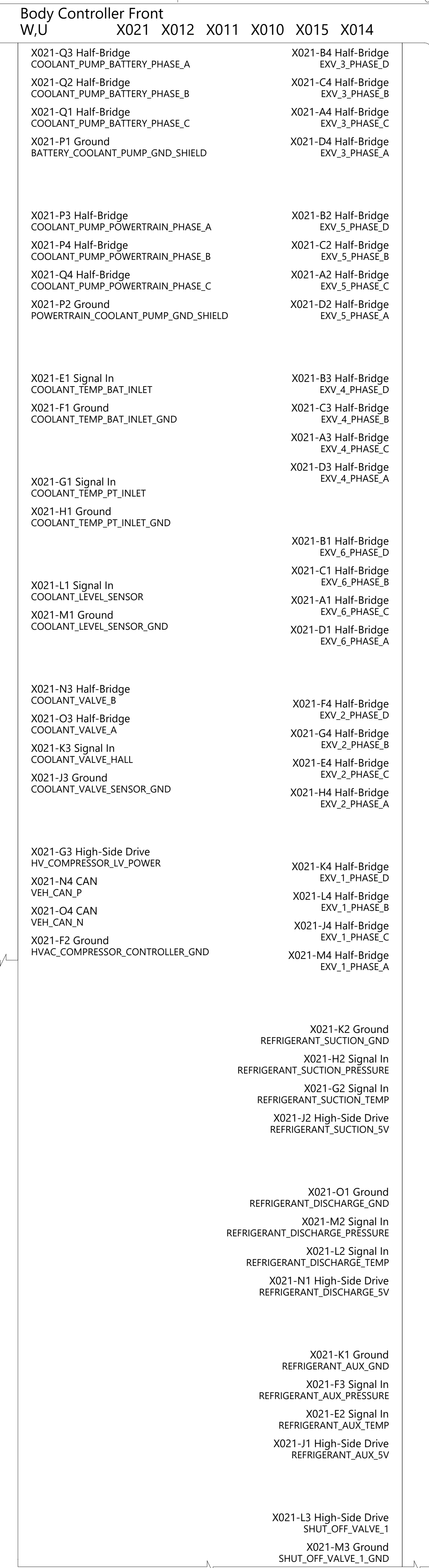
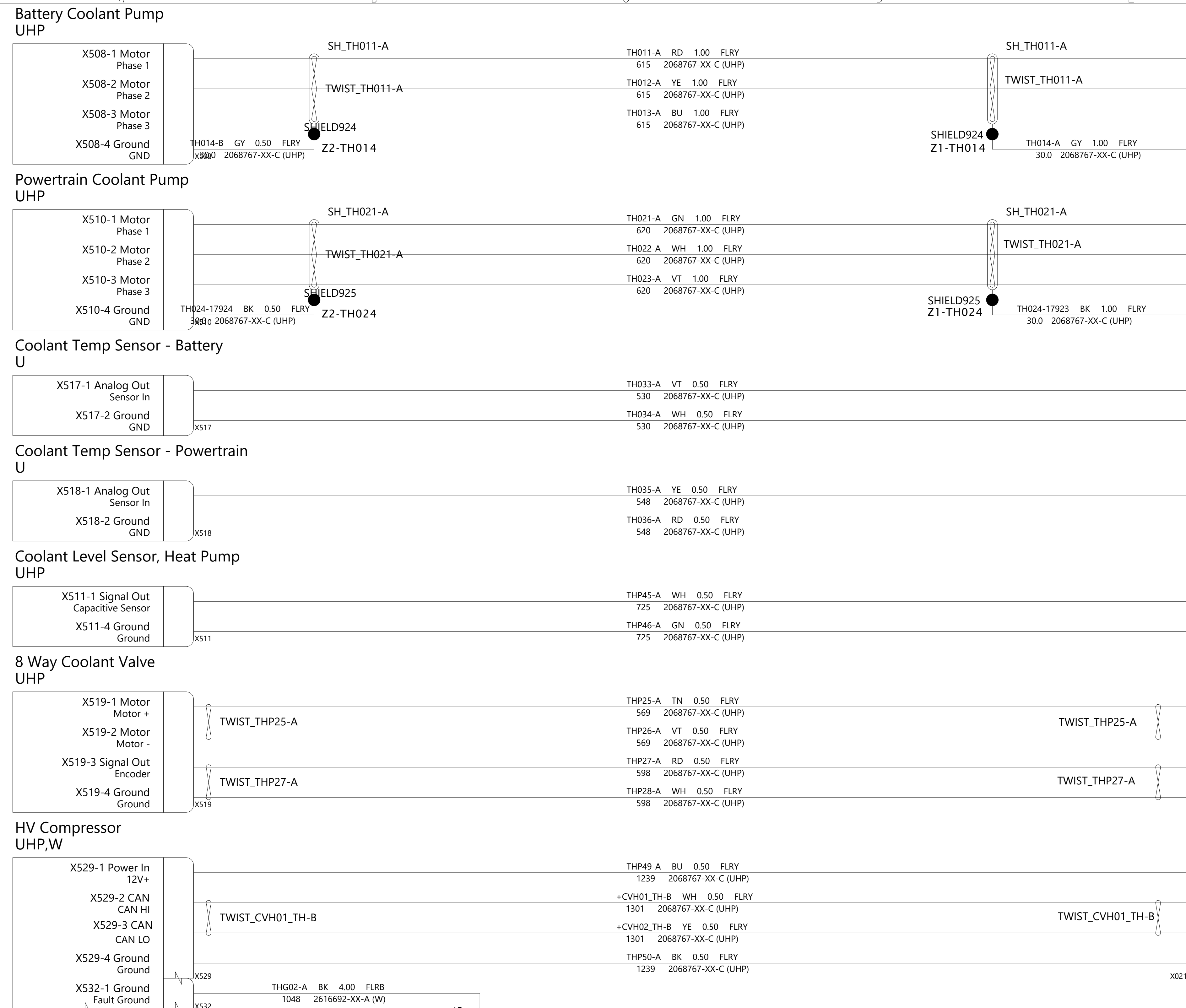

THE INFORMATION CONTAINED HEREIN IS DEEMED TO BE CONFIDENTIAL, PROPRIETARY, AND A TRADE SECRET OF TESLA MOTORS. THIS INFORMATION MAY NOT BE USED, REPRODUCED, OR DISCLOSED AS THE DIRECT OR INDIRECT BASIS FOR THE DEVELOPMENT, MANUFACTURE, OR SALE OF PROCESSES OR PRODUCTS WITHOUT THE EXPRESS WRITTEN CONSENT OF TESLA MOTORS.

DRAWN	CHECKED	APPROVED
-------	---------	----------

MATERIAL AS SPECIFIED	FINISHING AS SPECIFIED	SCALE NONE
--------------------------	---------------------------	---------------

PART NAME
HVAC - Heat Pump

PART NUMBER	REV	SHEET	SIZE
	1	27 OF 55	A0

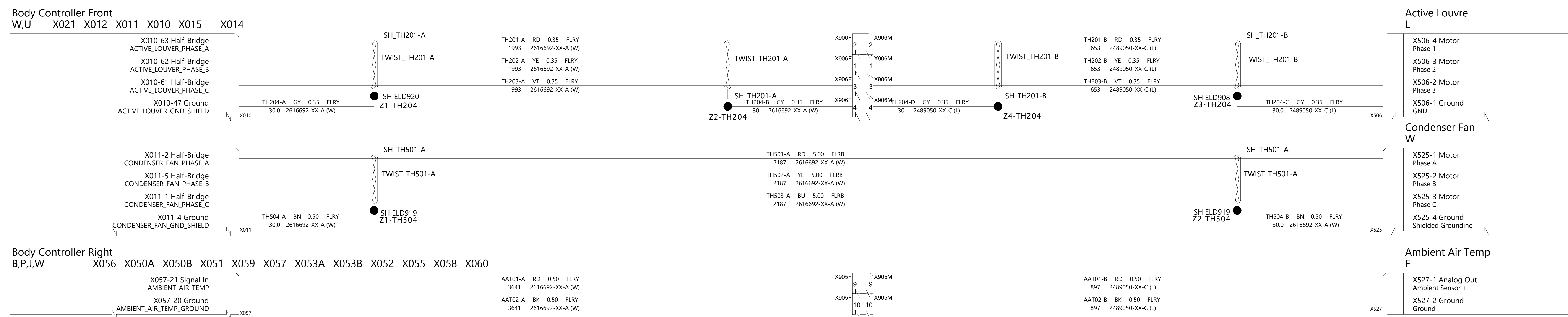

TESLA

THE INFORMATION CONTAINED HEREIN IS DEEMED TO BE CONFIDENTIAL, PROPRIETARY, AND A TRADE SECRET OF TESLA MOTORS. THIS INFORMATION MAY NOT BE USED, REPRODUCED, OR DISCLOSED AS THE DIRECT OR INDIRECT BASIS FOR THE DEVELOPMENT, MANUFACTURE, OR SALE OF PROCESSES OR PRODUCTS WITHOUT THE EXPRESS WRITTEN CONSENT OF TESLA MOTORS.

DRAWN		CHECKED		APPROVED	
MATERIAL AS SPECIFIED		FINISHING AS SPECIFIED		SCALE NONE	
PART NAME HVAC - Powertrain					
PART NUMBER		REV	SHEET	SIZE	
		1	28 OF 55	A0	

Body Controller Left
A,D,J,W X036 X030A X030B X031 X039 X037 X033A X033B X032 X035 X038



Body Controller Right
B,P,J,W X050A X050B X051 X059 X057 X053A X053B X052 X055 X058 X060

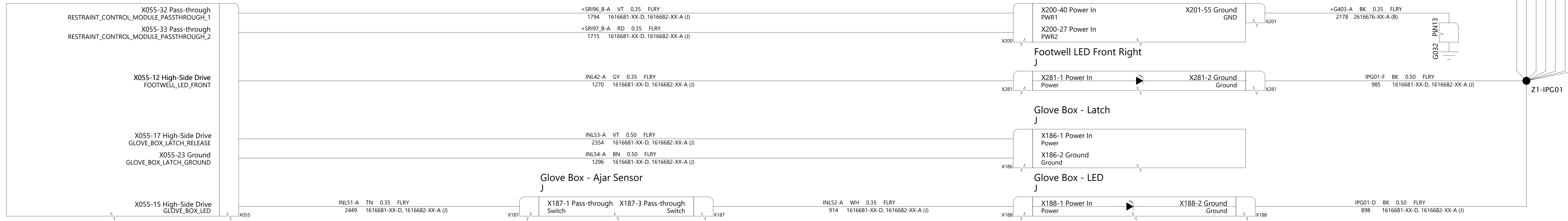

THE INFORMATION CONTAINED HEREIN IS DEEMED TO BE CONFIDENTIAL, PROPRIETARY, AND A TRADE SECRET OF TESLA MOTORS. THIS INFORMATION MAY NOT BE USED, REPRODUCED, OR DISCLOSED AS THE DIRECT OR INDIRECT BASIS FOR THE DEVELOPMENT, MANUFACTURE, OR SALE OF PROCESSES OR PRODUCTS WITHOUT THE EXPRESSED WRITTEN CONSENT OF TESLA MOTORS.

DRAWN	CHECKED	APPROVED
MATERIAL AS SPECIFIED	FINISHING AS SPECIFIED	SCALE NONE
PART NAME Instrument Panel		
PART NUMBER	REV 1	SHEET 30 OF 55
		SIZE A0

Body Controller Left
A,D,J,W X036 X030A X030B X031 X0309 X033A X033B X032 X035 X038



Body Controller Right
B,P,J,W X056 X050A X050B X051 X059 X057 X053A X053B X052 X055 X058 X060

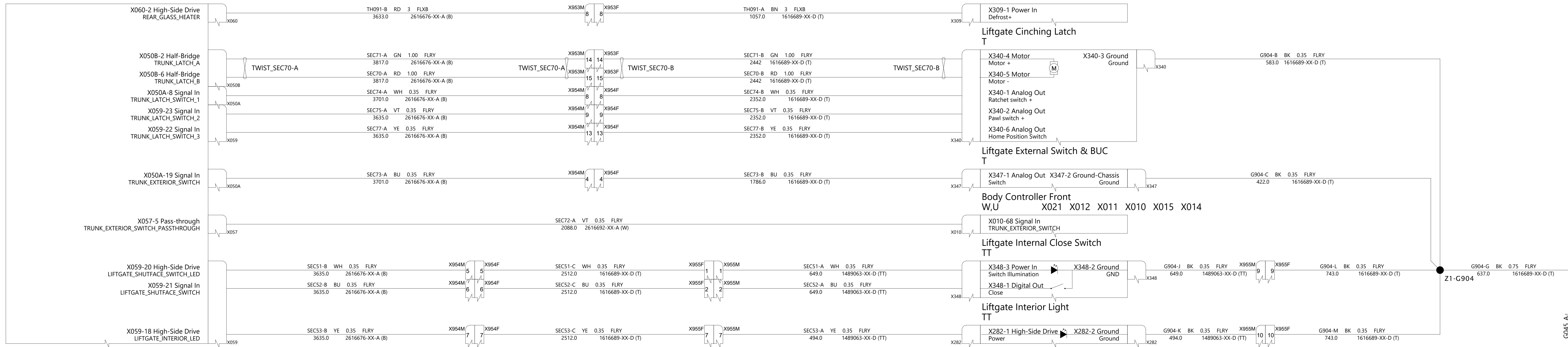

THE INFORMATION CONTAINED HEREIN IS DEEMED TO BE CONFIDENTIAL, PROPRIETARY, AND A TRADE SECRET OF TESLA MOTORS. THIS INFORMATION MAY NOT BE USED, REPRODUCED, OR DISCLOSED AS THE DIRECT OR INDIRECT BASIS FOR THE DEVELOPMENT, MANUFACTURE, OR SALE OF PROCESSES OR PRODUCTS WITHOUT THE EXPRESSED WRITTEN CONSENT OF TESLA MOTORS.

DRAWN	CHECKED	APPROVED
MATERIAL AS SPECIFIED	FINISHING AS SPECIFIED	SCALE NONE
PART NAME Liftgate and Trunk		
PART NUMBER	REV	SHEET
	1	31 OF 55
		SCALE A0

Body Controller Front
W,U

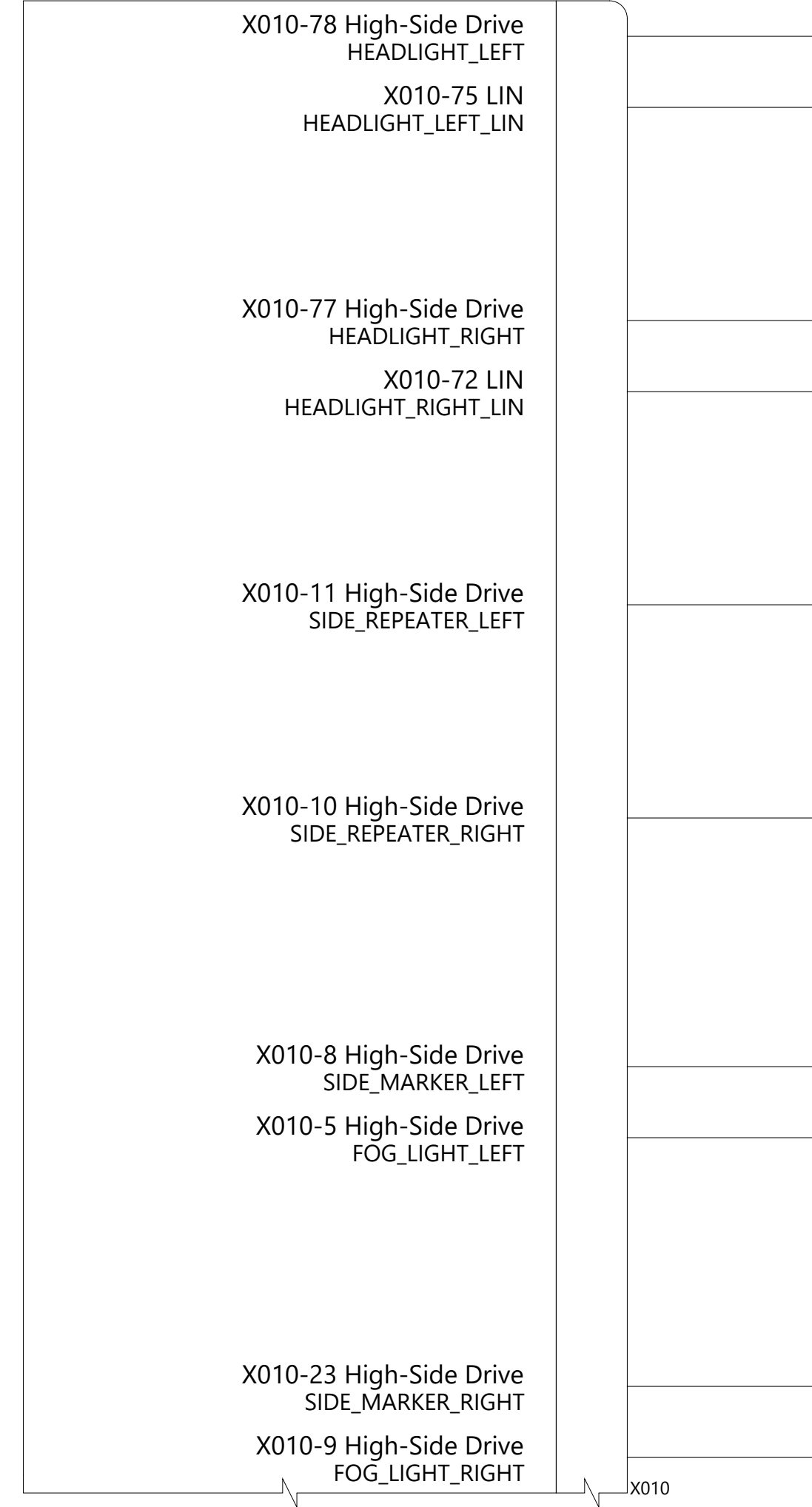

Body Controller Left
A,D,J,W

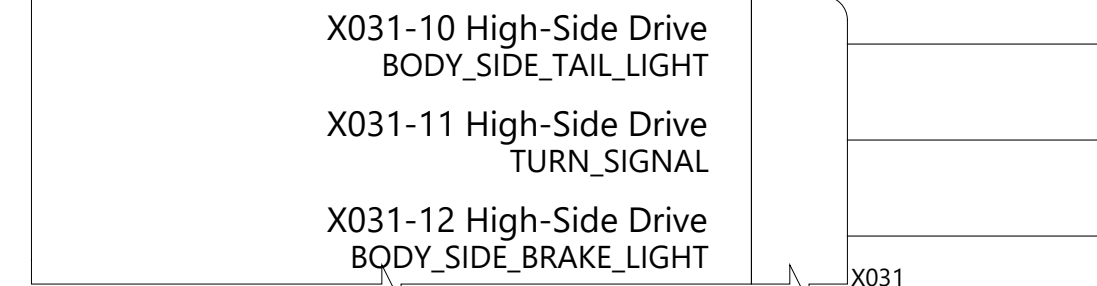

Body Controller Right
B,P,J,W

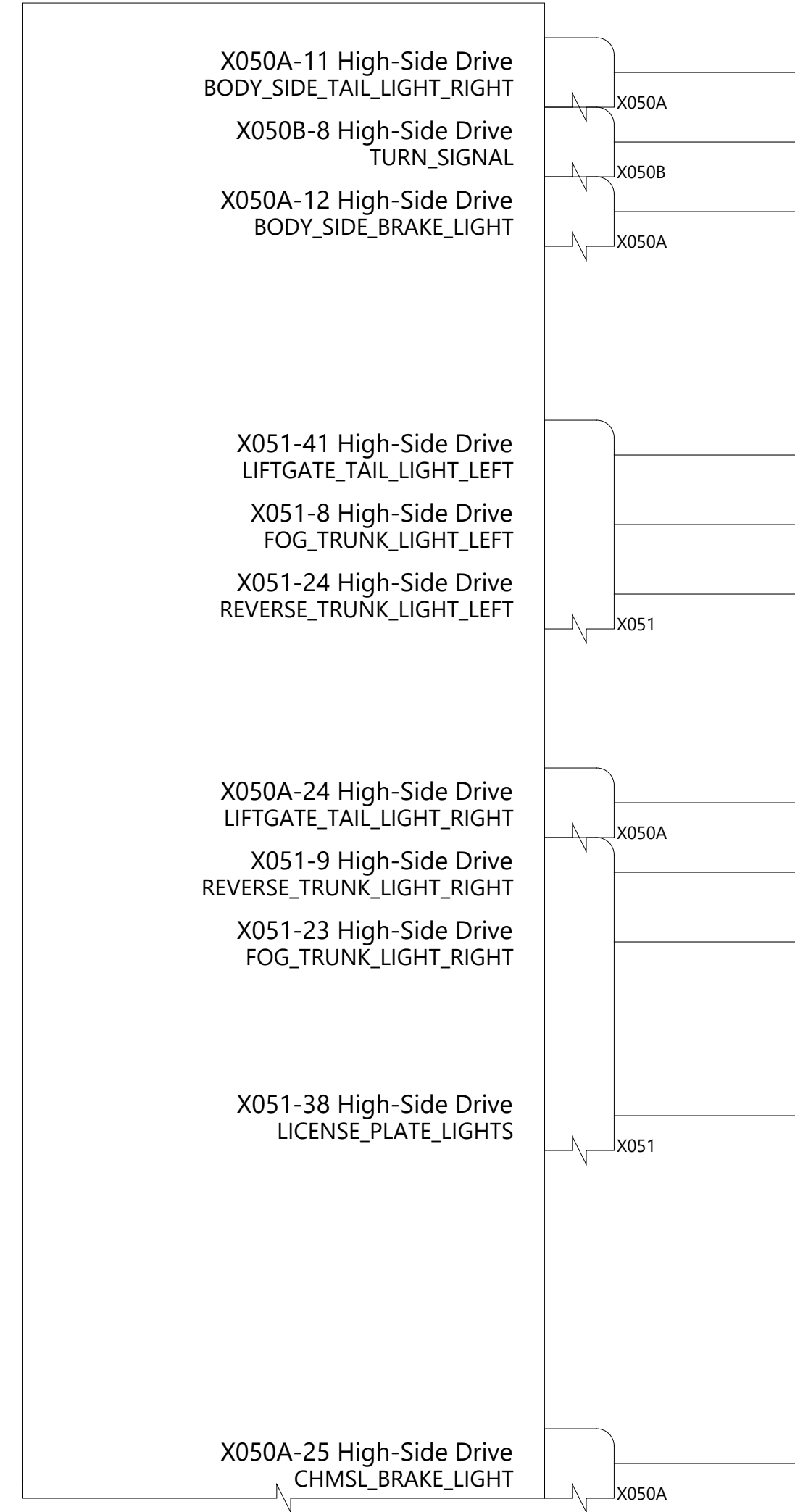

Headlight Left
W

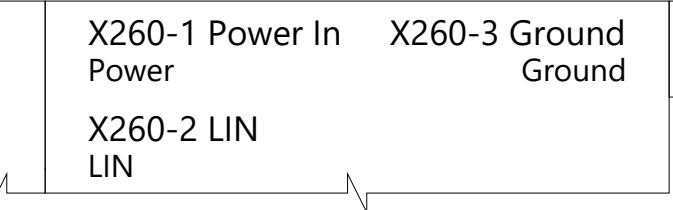

Headlight Right
W

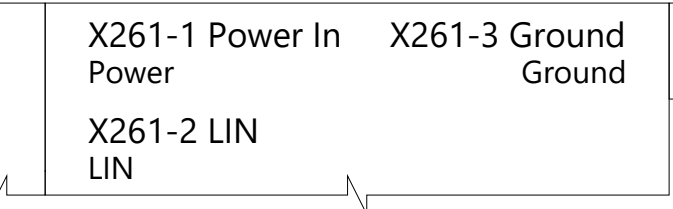

Side Repeater LED Left
W

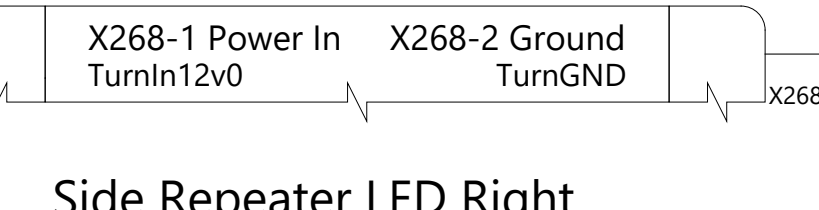

Side Repeater LED Right
W

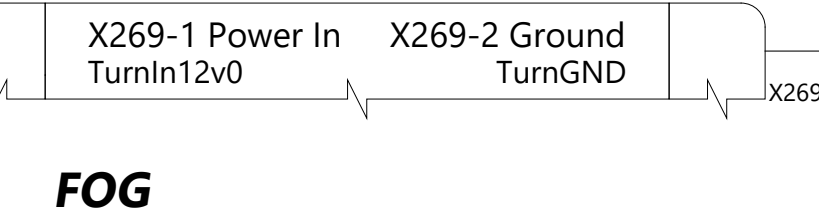

Fog Fascia Light Left
F

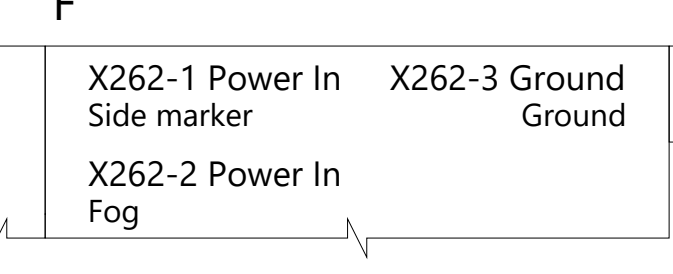

Fog Fascia Light Right
F

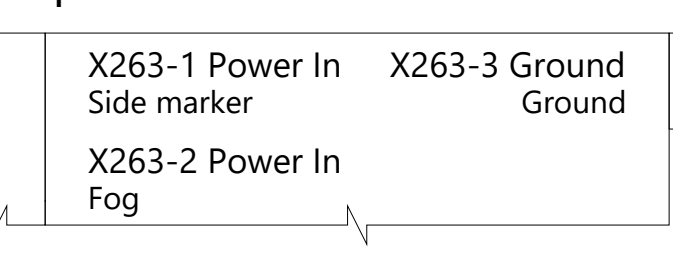

Tail Light Body LH
A

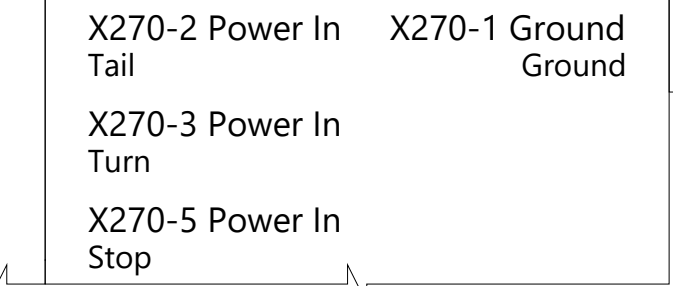

Tail Light Body RH
B

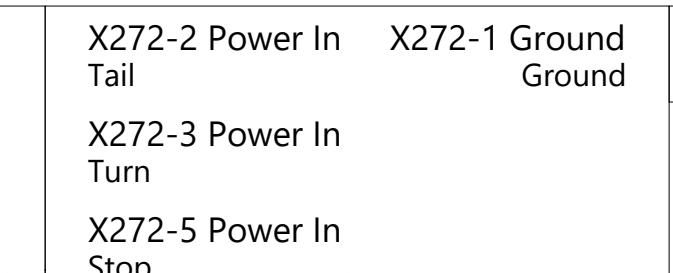

Tail Light Liftgate LH, Global
T

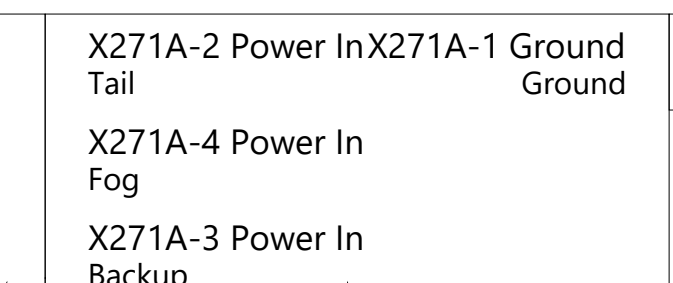

Tail Light Liftgate RH, Global
T

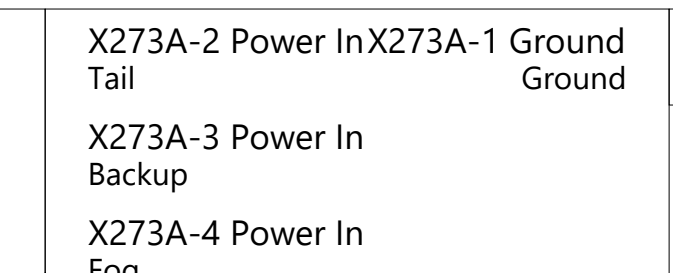

License Plate Light Left
T

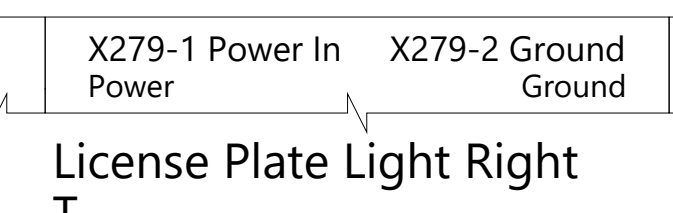

License Plate Light Right
T

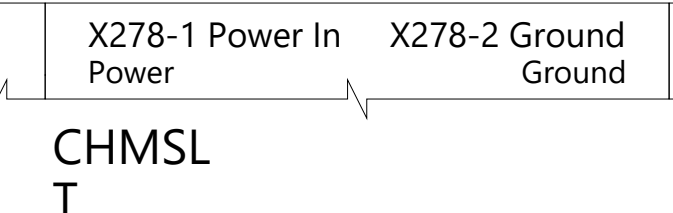

CHMSL
T

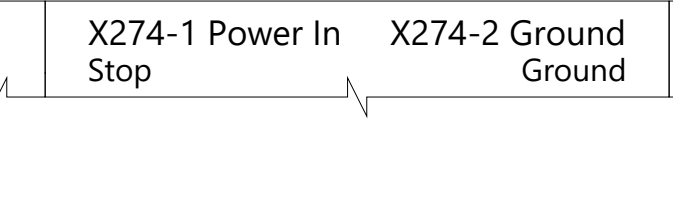

THE INFORMATION CONTAINED HEREIN IS DEEMED TO BE CONFIDENTIAL, PROPRIETARY, AND A TRADE SECRET OF TESLA MOTORS. THIS INFORMATION MAY NOT BE USED, REPRODUCED, OR DISCLOSED AS THE DIRECT OR INDIRECT BASIS FOR THE DEVELOPMENT, MANUFACTURE, OR SALE OF PROCESSES OR PRODUCTS WITHOUT THE EXPRESSED WRITTEN CONSENT OF TESLA MOTORS.

DRAWN	CHECKED	APPROVED

MATERIAL	FINISHING	SCALE
AS SPECIFIED	AS SPECIFIED	NONE

PART NAME
Lighting - Exterior

PART NUMBER	REV	SHEET	SIZE
	1	32 OF 55	A0

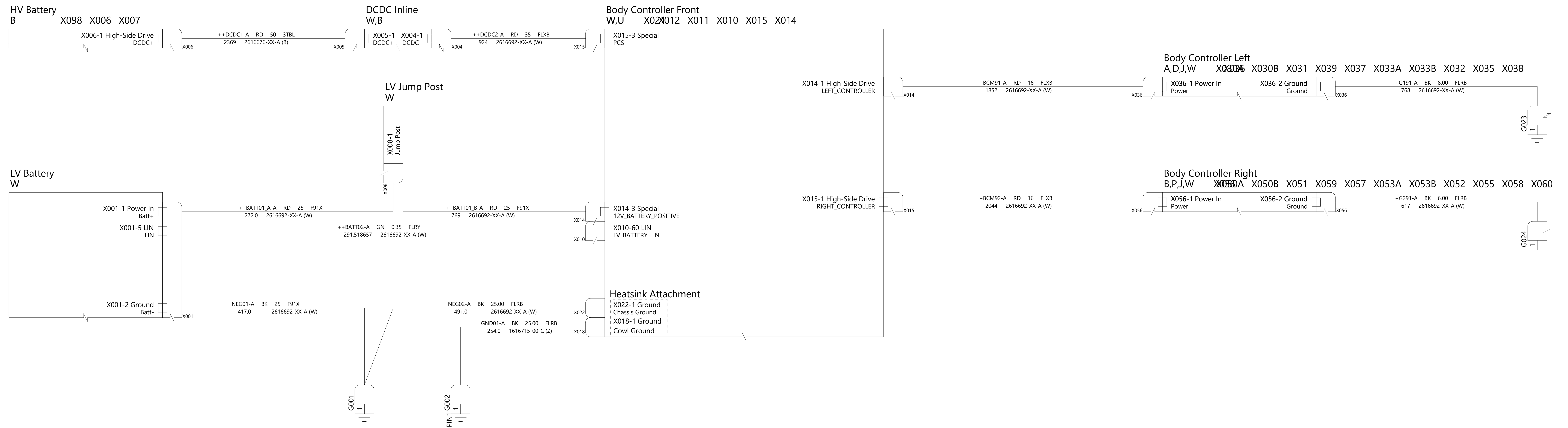

TESLA

THE INFORMATION CONTAINED HEREIN IS DEEMED TO BE CONFIDENTIAL, PROPRIETARY, AND A TRADE SECRET OF TESLA MOTORS. THIS INFORMATION MAY NOT BE USED, REPRODUCED, OR DISCLOSED AS THE DIRECT OR INDIRECT BASIS FOR THE DEVELOPMENT, MANUFACTURE, OR SALE OF PROCESSES OR PRODUCTS WITHOUT THE EXPRESSED WRITTEN CONSENT OF TESLA MOTORS.

DRAWN	CHECKED	APPROVED

MATERIAL AS SPECIFIED	FINISHING AS SPECIFIED	SCALE NONE
--------------------------	---------------------------	---------------

PART NAME
Power Distribution - Main

PART NUMBER	REV	SHEET	SIZE
	1	33 OF 55	A0

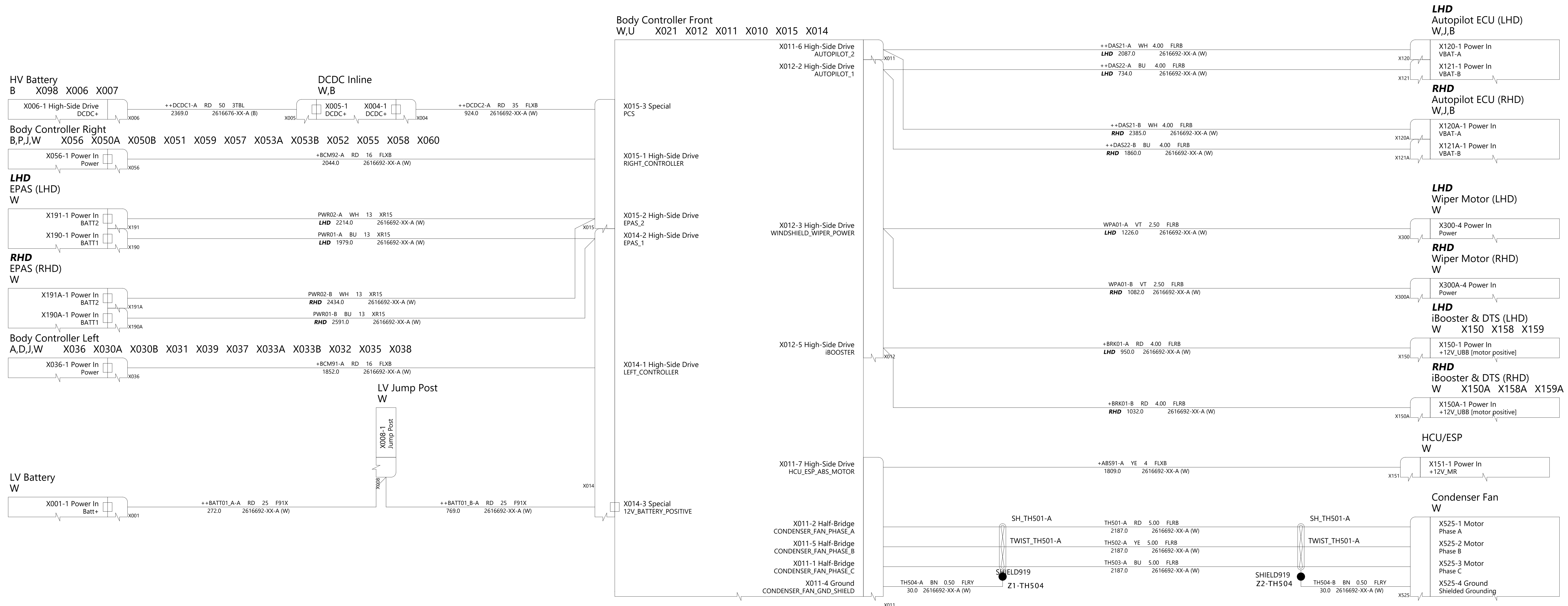

THE INFORMATION CONTAINED HEREIN IS DEEMED TO BE CONFIDENTIAL, PROPRIETARY, AND A TRADE SECRET OF TESLA MOTORS. THIS INFORMATION MAY NOT BE USED, REPRODUCED, OR DISCLOSED AS THE DIRECT OR INDIRECT BASIS FOR THE DEVELOPMENT, MANUFACTURE, OR SALE OF PROCESSES OR PRODUCTS WITHOUT THE EXPRESSED WRITTEN CONSENT OF TESLA MOTORS.

DRAWN	CHECKED	APPROVED
-------	---------	----------

MATERIAL AS SPECIFIED	FINISHING AS SPECIFIED	SCALE NONE
--------------------------	---------------------------	---------------

PART NAME
Power Distribution - VCFront 2/2

PART NUMBER	REV	SHEET	SIZE
	1	34 OF 55	A0

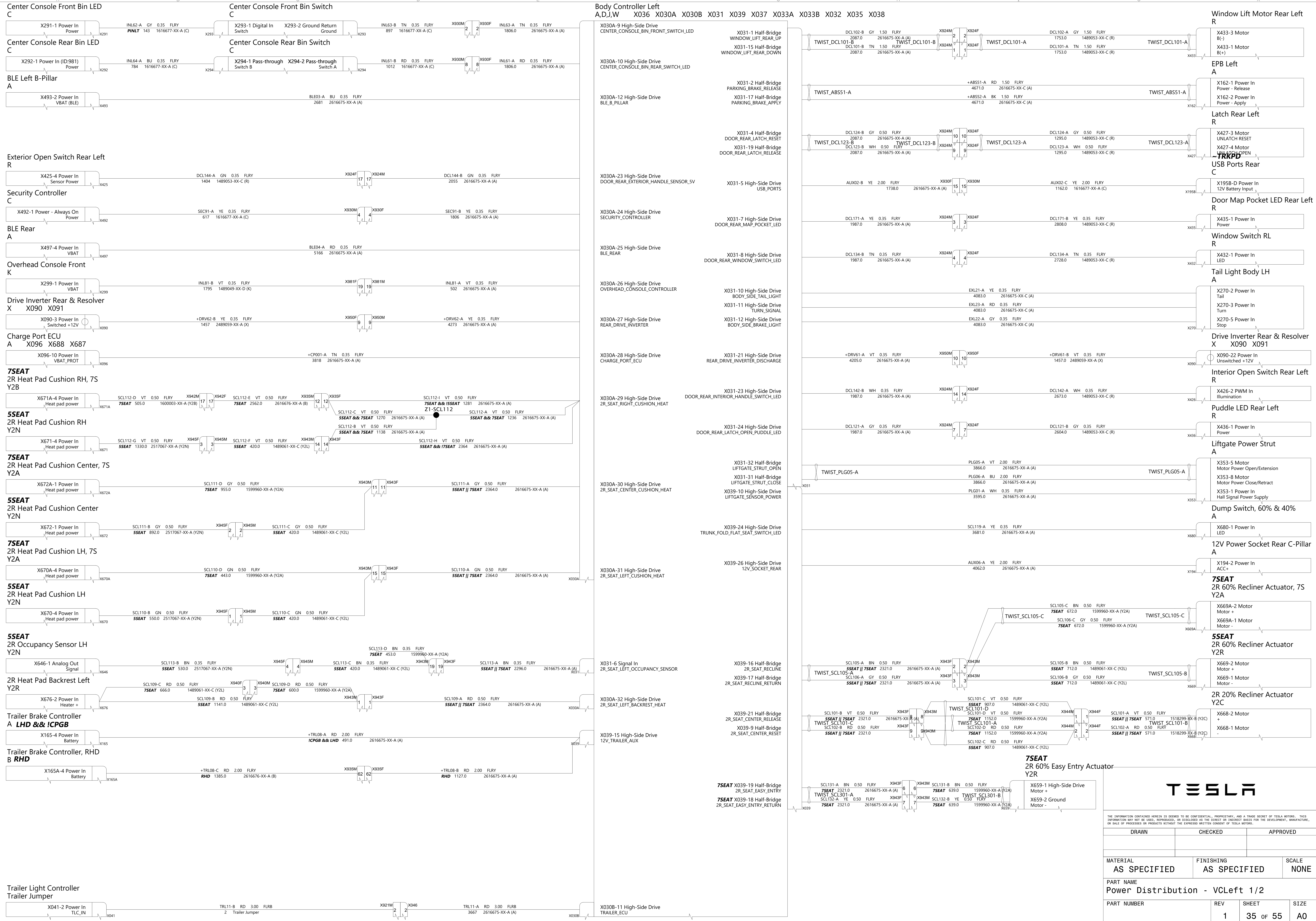

TESLA			
THE INFORMATION CONTAINED HEREIN IS DEEMED TO BE CONFIDENTIAL, PROPRIETARY, AND A TRADE SECRET OF TESLA MOTORS. THIS INFORMATION MAY NOT BE USED, REPRODUCED, OR DISCLOSED AS THE DIRECT OR INDIRECT BASIS FOR THE DEVELOPMENT, MANUFACTURE, OR SALE OF PROCESSES OR PRODUCTS WITHOUT THE EXPRESSED WRITTEN CONSENT OF TESLA MOTORS.			
DRAWN	CHECKED	APPROVED	
MATERIAL AS SPECIFIED	FINISHING AS SPECIFIED	SCALE NONE	
PART NAME Power Distribution - VLeft 1/2			
PART NUMBER	REV	SHEET	SIZE
	1	35 OF 55	A0

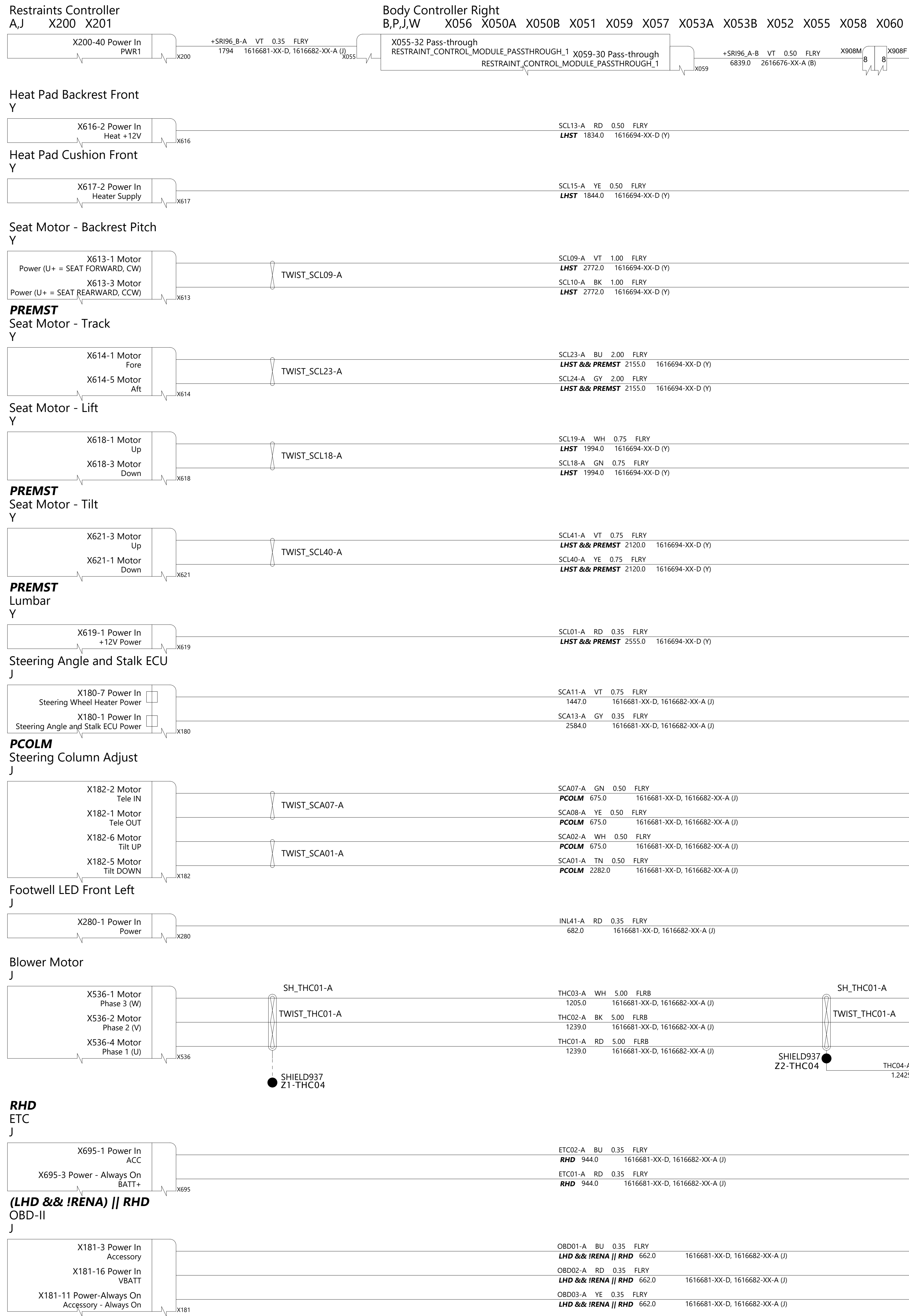

Body Controller Right
B,P,J,W X056 X050A X050B X051 X059 X057 X053A X053B X052 X055 X058 X060

Body Controller Left
A,D,J,W X036 X030A X030B X031 X039 X037 X033A X033B X032 X035 X038

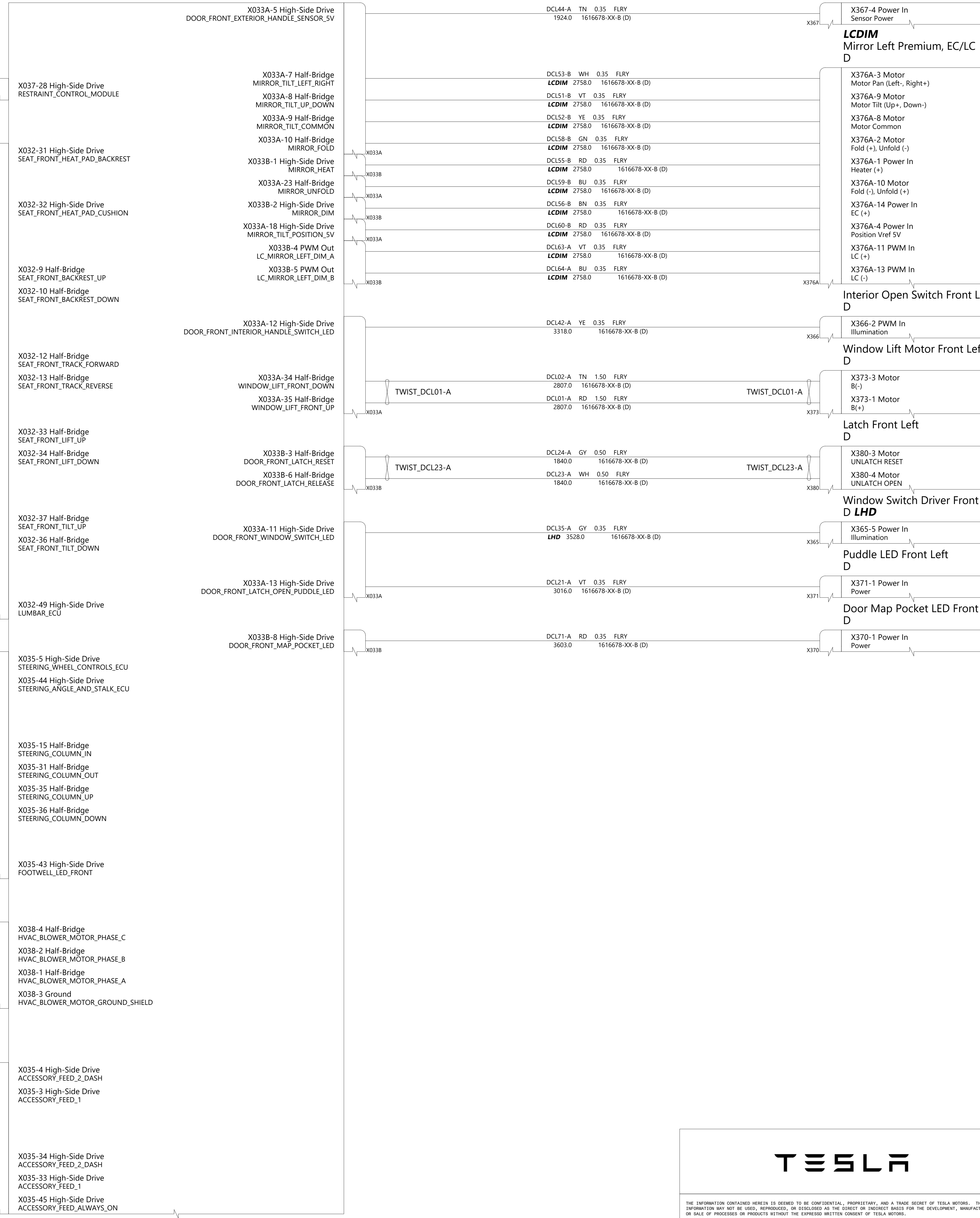

Exterior Open Switch Front Left
D

LCDIM
Mirror Left Premium, EC/LC
D

Interior Open Switch Front Left
D

Window Lift Motor Front Left
D

Latch Front Left
D

Window Switch Driver Front Left
D LHD

Puddle LED Front Left
D

Door Map Pocket LED Front Left
D



THE INFORMATION CONTAINED HEREIN IS DEEMED TO BE CONFIDENTIAL, PROPRIETARY, AND A TRADE SECRET OF TESLA MOTORS. THIS INFORMATION MAY NOT BE USED, REPRODUCED, OR DISCLOSED AS THE DIRECT OR INDIRECT BASIS FOR THE DEVELOPMENT, MANUFACTURE, OR SALE OF PROCESSES OR PRODUCTS WITHOUT THE EXPRESSED WRITTEN CONSENT OF TESLA MOTORS.

DRAWN	CHECKED	APPROVED
MATERIAL AS SPECIFIED	FINISHING AS SPECIFIED	SCALE NONE
PART NAME Power Distribution - VLeft 2/2		
PART NUMBER	REV	SHEET
	1	36 OF 55
		SIZE A0

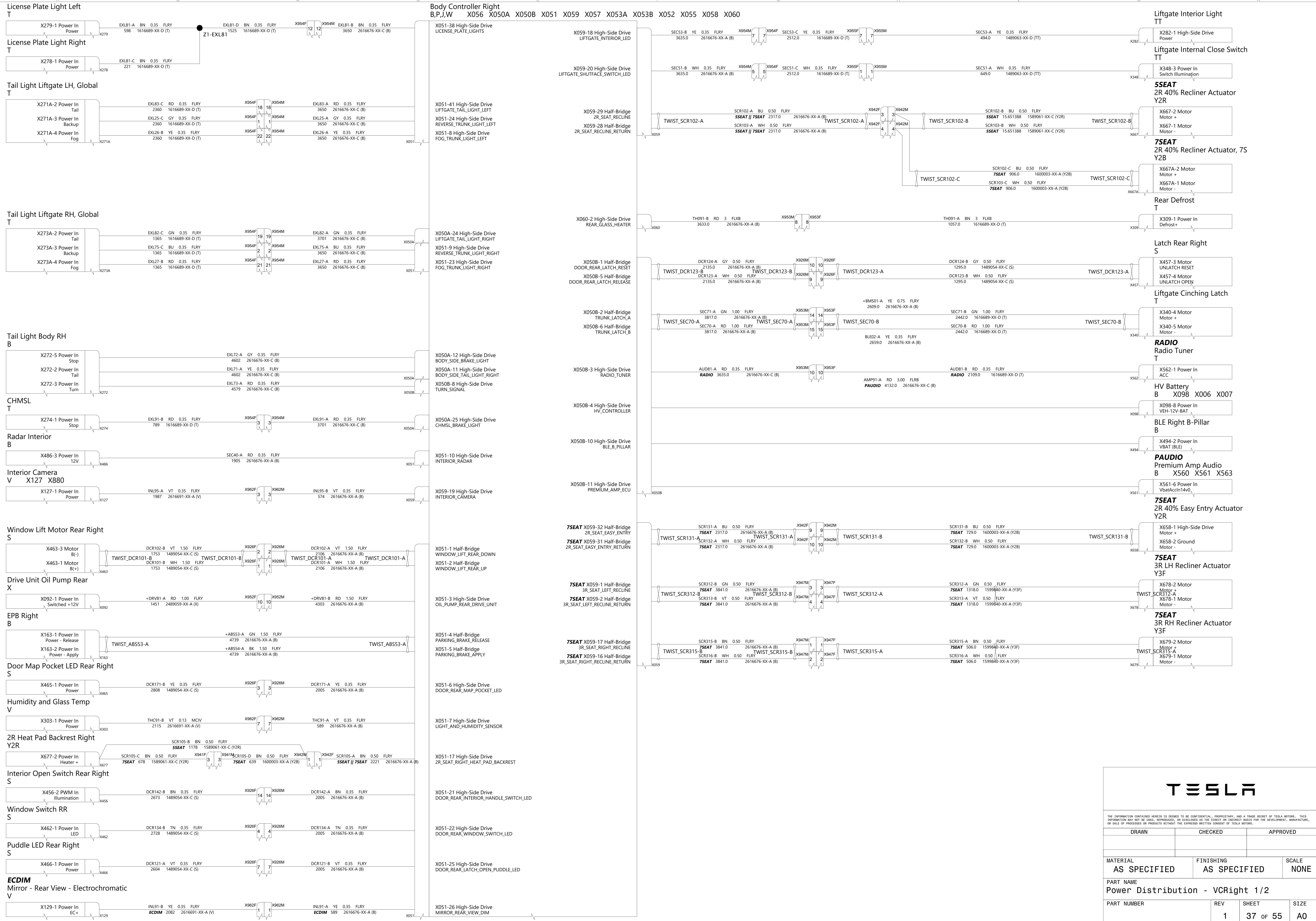

TESLA			
THE INFORMATION CONTAINED HEREIN IS DEEMED TO BE CONFIDENTIAL, PROPRIETARY, AND A TRADE SECRET OF TESLA MOTORS. THIS INFORMATION MAY NOT BE USED, REPRODUCED, OR DISCLOSED AS THE DIRECT OR INDIRECT BASIS FOR THE DEVELOPMENT, MANUFACTURE, OR SALE OF PROCESSES OR PRODUCTS WITHOUT THE EXPRESSED WRITTEN CONSENT OF TESLA MOTORS.			
DRAWN	CHECKED	APPROVED	
MATERIAL AS SPECIFIED		FINISHING AS SPECIFIED	
PART NAME Power Distribution - VCRight 1/2		SCALE NONE	
PART NUMBER	REV	SHEET	SIZE
	1	37 OF 55	A0

Restraints Controller
A,J X200 X201



Body Controller Front
W,U X021 X012 X011 X010 X015 X014



HV Battery
B X098 X006 X007

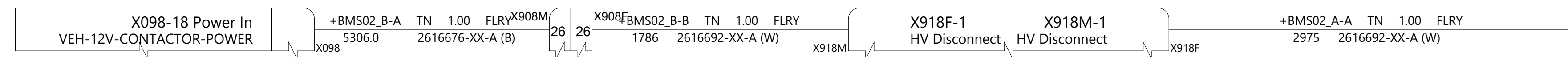

PREMST
Seat Motor - Track
Y

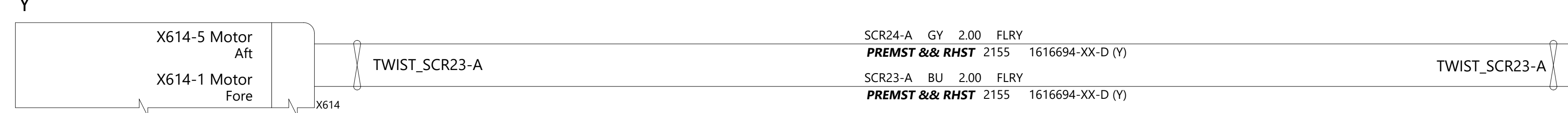

Seat Motor - Backrest Pitch
Y

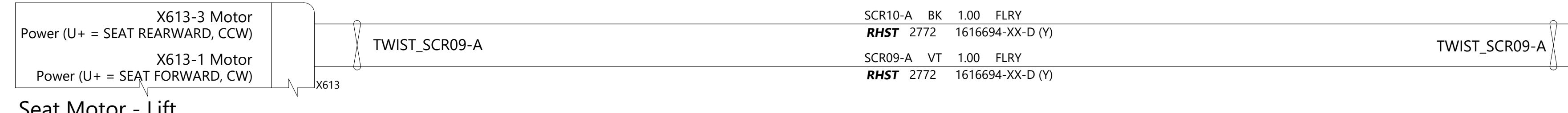

Seat Motor - Lift
Y

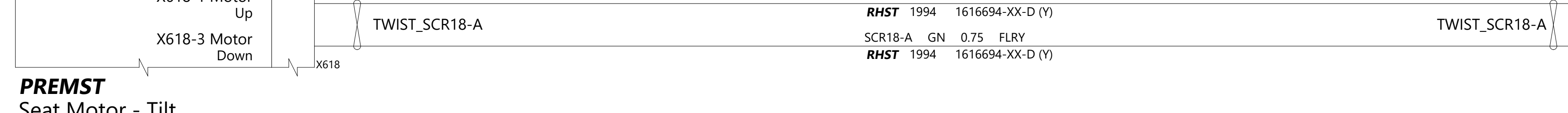

PREMST
Seat Motor - Tilt
Y

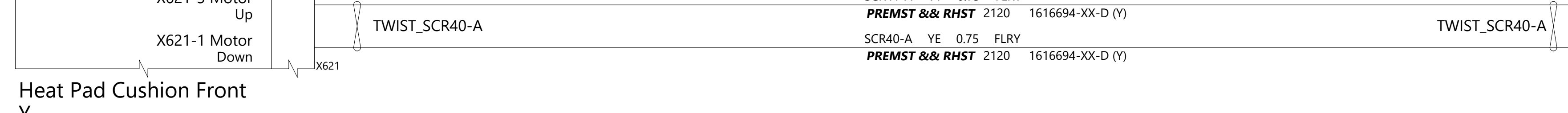

Heat Pad Cushion Front
Y



Heat Pad Backrest Front
Y



PREMST
Lumbar
Y



Footwell LED Front Right
J



Cabin Thermistors
J

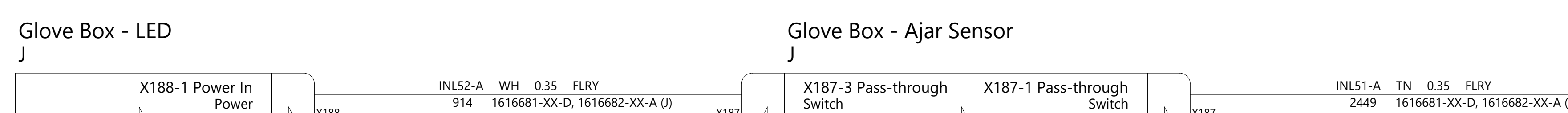

Glove Box - LED
J

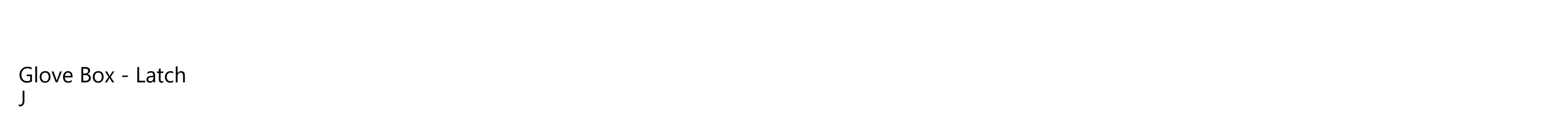

Glove Box - Latch
J



Lateral Vanes Left
J

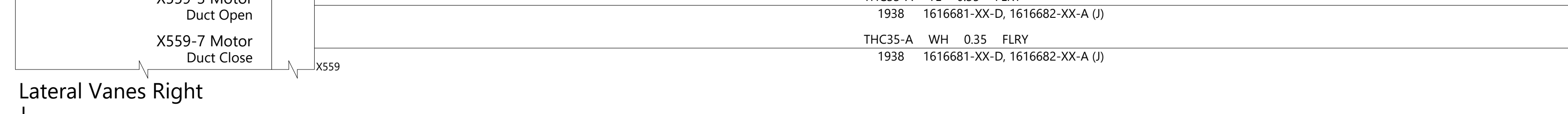

Lateral Vanes Right
J

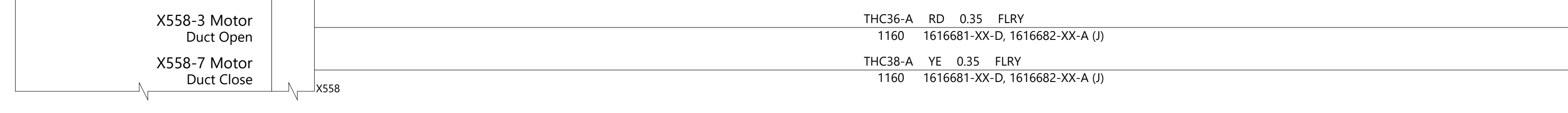

Body Controller Right
B,P,J,W X050A X050B X051 X059 X057 X053A X053B X052 X055 X058 X060

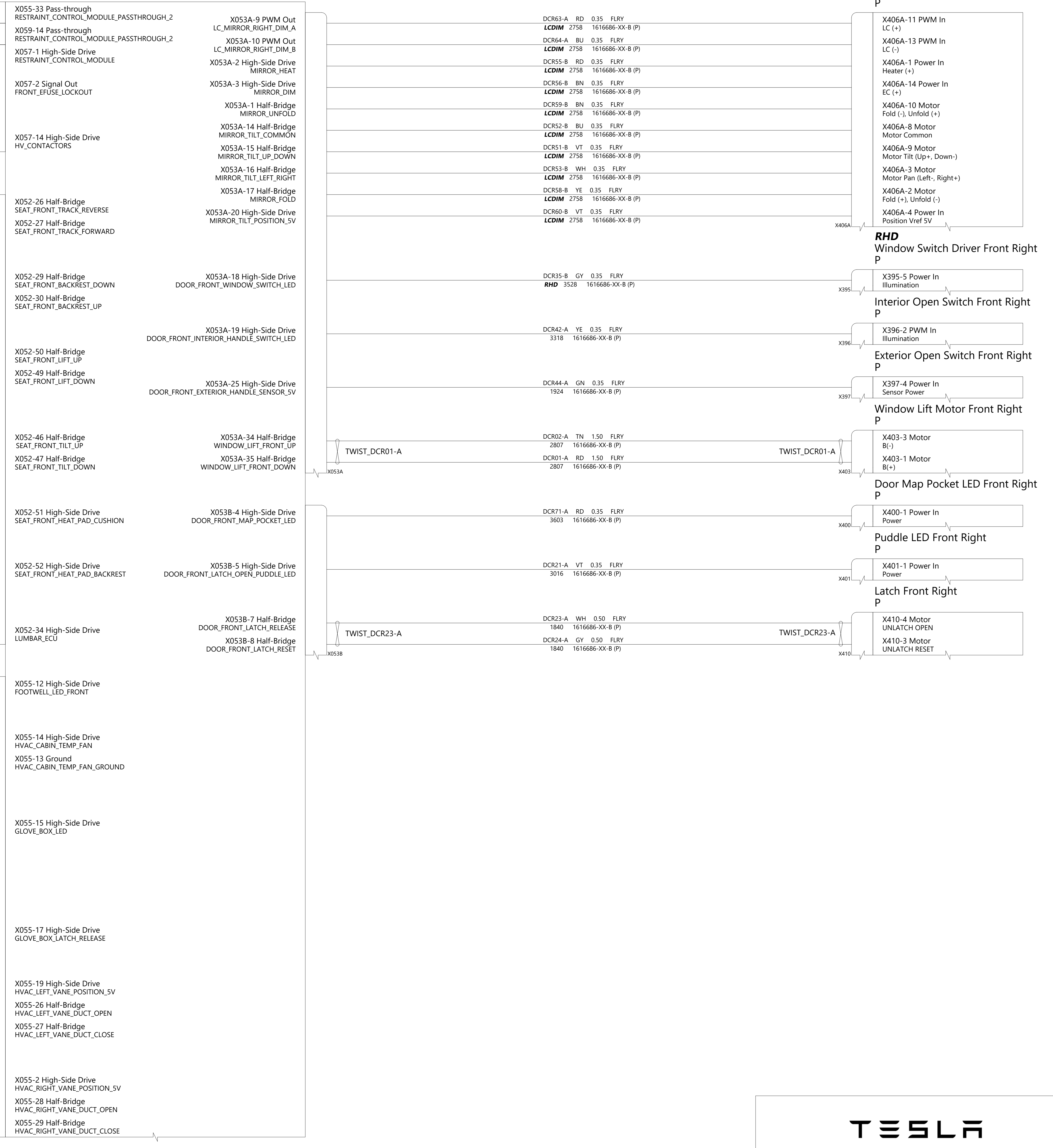

LCDIM
Mirror Right Premium, EC/LC P

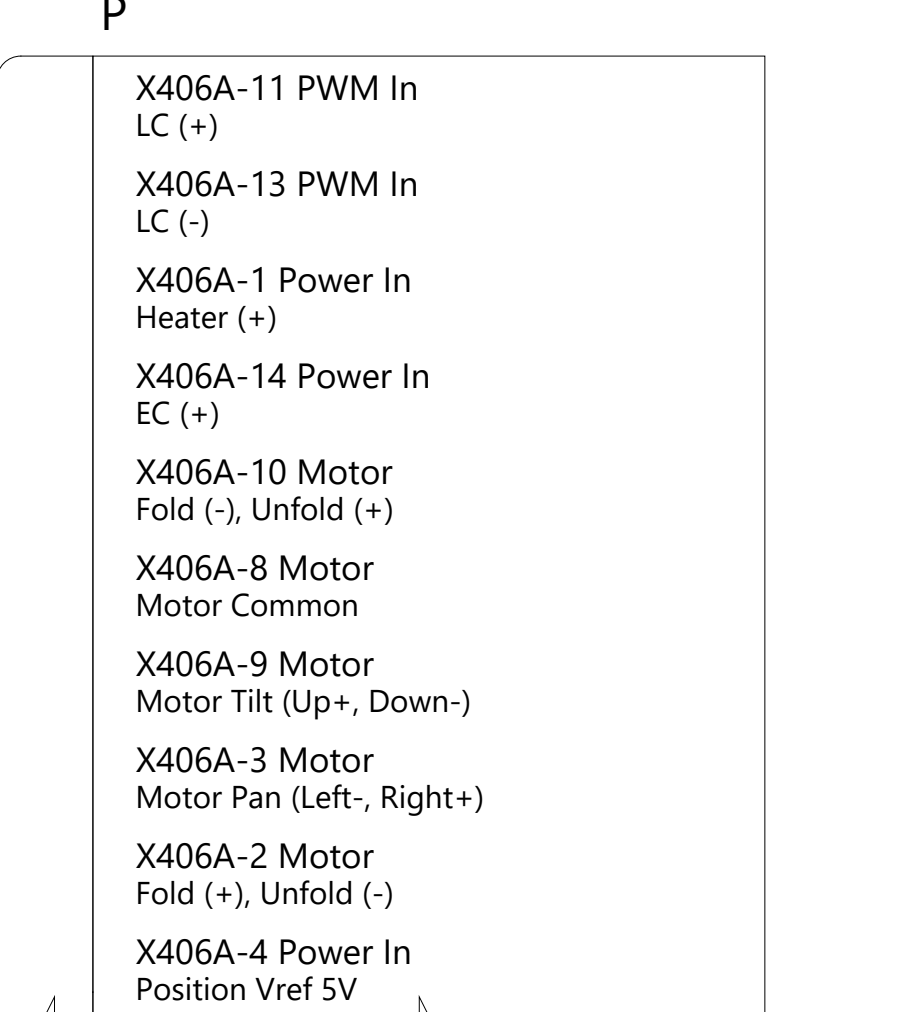

RHD
Window Switch Driver Front Right p

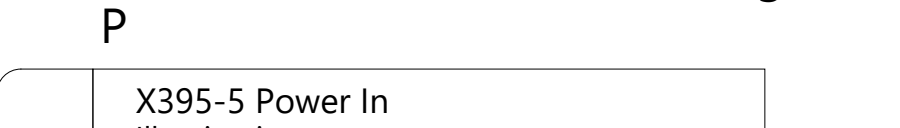

Interior Open Switch Front Right p



Exterior Open Switch Front Right p

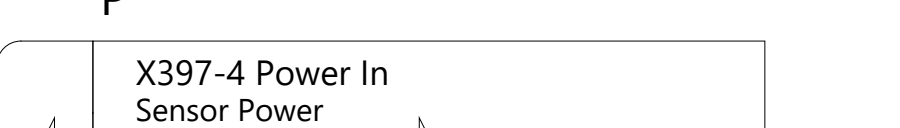

Window Lift Motor Front Right p

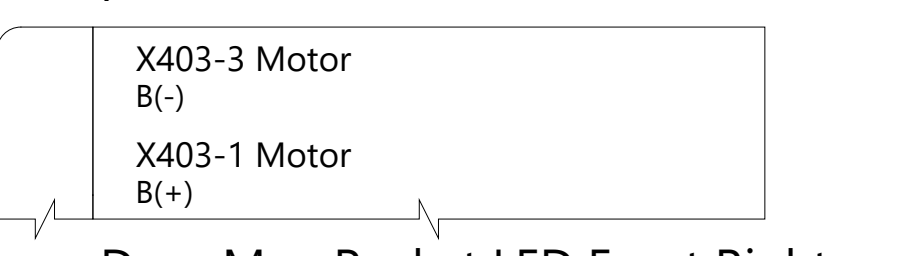

Door Map Pocket LED Front Right p



Puddle LED Front Right p



Latch Front Right p

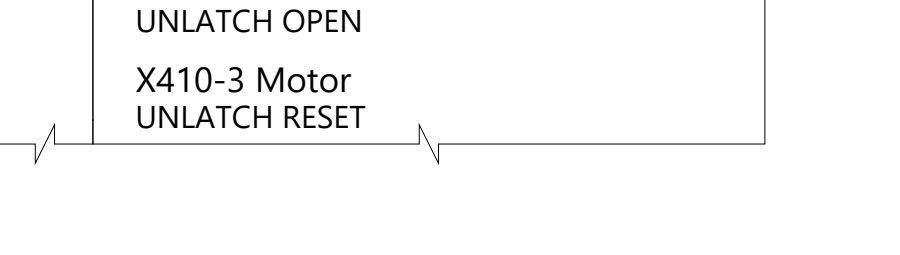

THE INFORMATION CONTAINED HEREIN IS DEEMED TO BE CONFIDENTIAL, PROPRIETARY, AND A TRADE SECRET OF TESLA MOTORS. THIS INFORMATION MAY NOT BE USED, REPRODUCED, OR DISCLOSED AS THE DIRECT OR INDIRECT BASIS FOR THE DEVELOPMENT, MANUFACTURE, OR SALE OF PROCESSES OR PRODUCTS WITHOUT THE EXPRESSED WRITTEN CONSENT OF TESLA MOTORS.

DRAWN	CHECKED	APPROVED
MATERIAL AS SPECIFIED	FINISHING AS SPECIFIED	SCALE NONE
PART NAME Power Distribution - VCRight 2/2		
PART NUMBER	REV	SHEET
	1	38 OF 55
		SIZE A0

Restraints Controller
A,J X200 X201

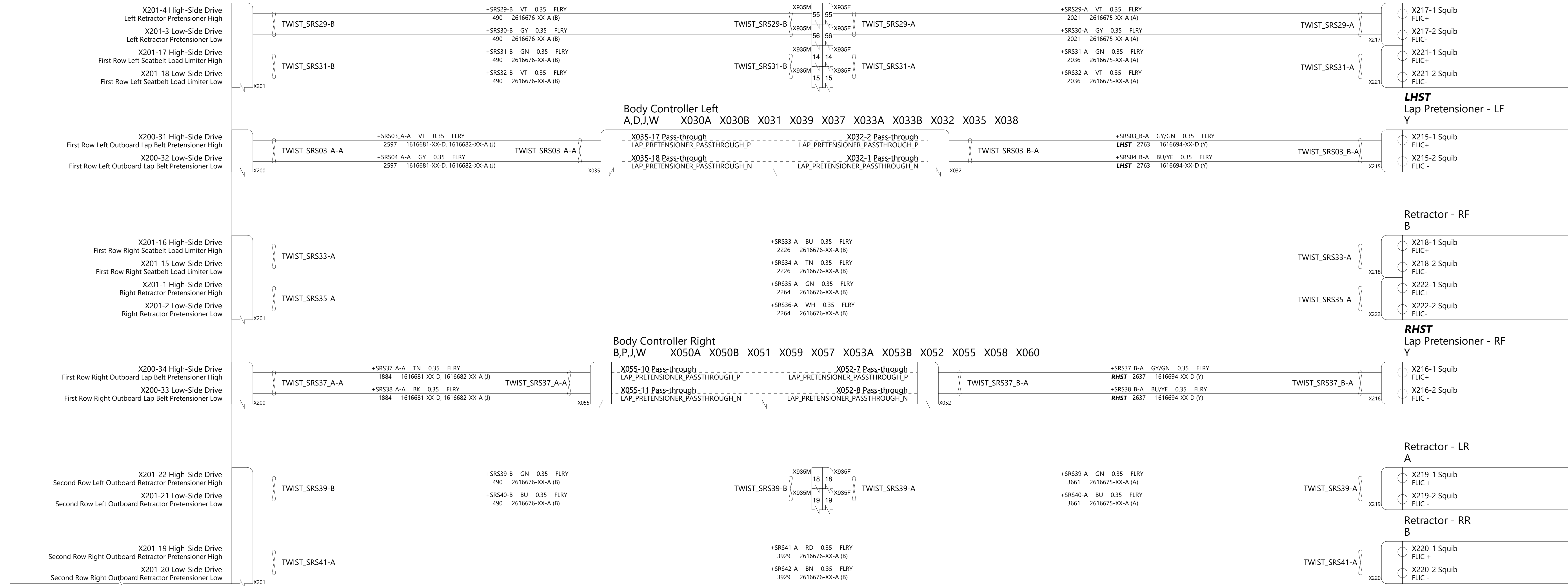

THE INFORMATION CONTAINED HEREIN IS DEEMED TO BE CONFIDENTIAL, PROPRIETARY, AND A TRADE SECRET OF TESLA MOTORS. THIS INFORMATION MAY NOT BE USED, REPRODUCED, OR DISCLOSED AS THE DIRECT OR INDIRECT BASIS FOR THE DEVELOPMENT, MANUFACTURE, OR SALE OF PROCESSES OR PRODUCTS WITHOUT THE EXPRESSED WRITTEN CONSENT OF TESLA MOTORS.

DRAWN	CHECKED	APPROVED
MATERIAL AS SPECIFIED	FINISHING AS SPECIFIED	SCALE NONE
PART NAME Restraints Controller - Retractors		
PART NUMBER	REV	SHEET
	1	40 OF 55
		SIZE A0

Restraints Controller
A,J X200 X201

Body Controller Right
B,P,J,W X050A X050B X051 X059 X057 X053A X053B X052 X055 X058 X060

LHD
MCU (LHD)
W,B

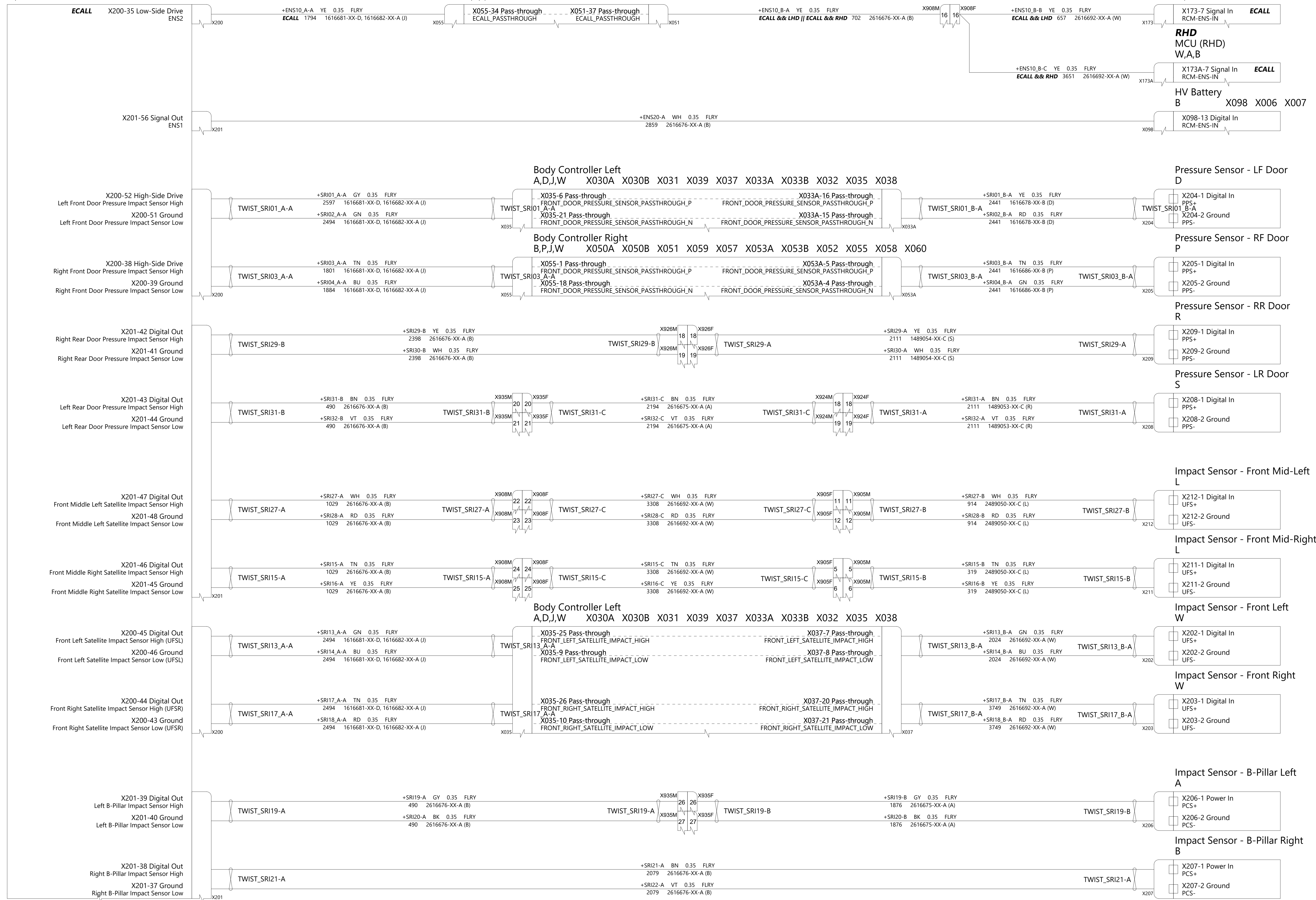

THE INFORMATION CONTAINED HEREIN IS DEEMED TO BE CONFIDENTIAL, PROPRIETARY, AND A TRADE SECRET OF TESLA MOTORS. THIS INFORMATION MAY NOT BE USED, REPRODUCED, OR DISCLOSED AS THE DIRECT OR INDIRECT BASIS FOR THE DEVELOPMENT, MANUFACTURE, OR SALE OF PROCESSES OR PRODUCTS WITHOUT THE EXPRESSED WRITTEN CONSENT OF TESLA MOTORS.

DRAWN	CHECKED	APPROVED
MATERIAL AS SPECIFIED	FINISHING AS SPECIFIED	SCALE NONE
PART NAME Restraints Controller - Sensors		
PART NUMBER	REV	SHEET
	1	41 OF 55
		SIZE A0

LHD
MCU (LHD)
W,B

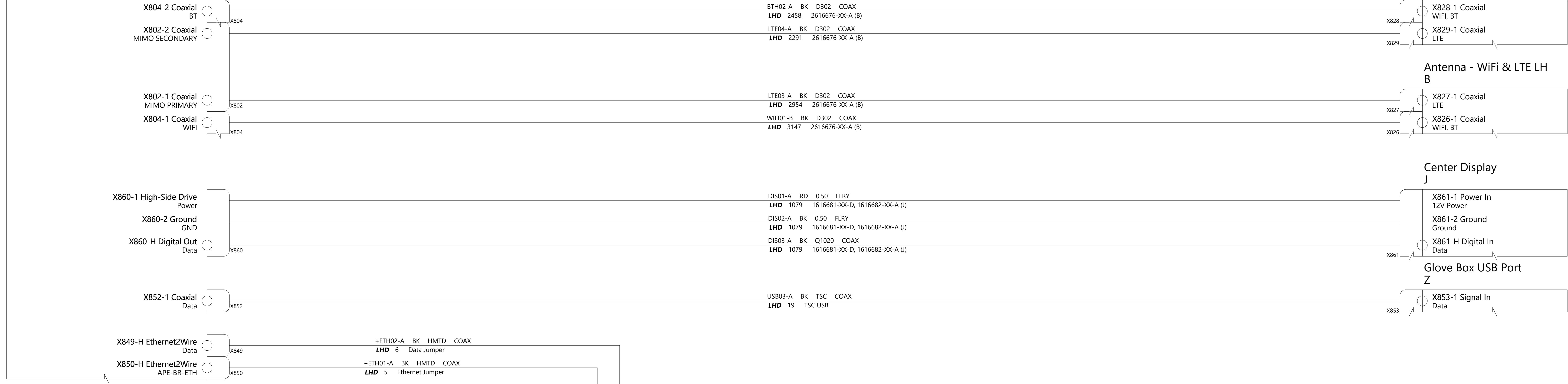

Antenna - WiFi & LTE RH
B

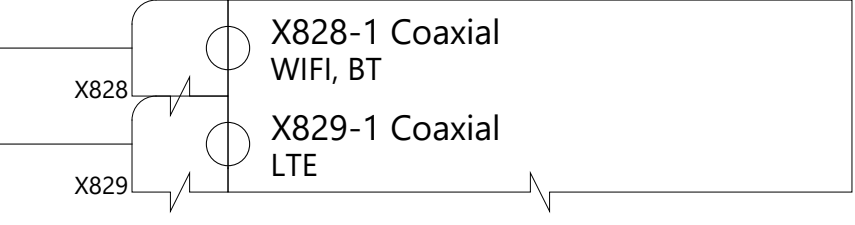

Antenna - WiFi & LTE LH
B

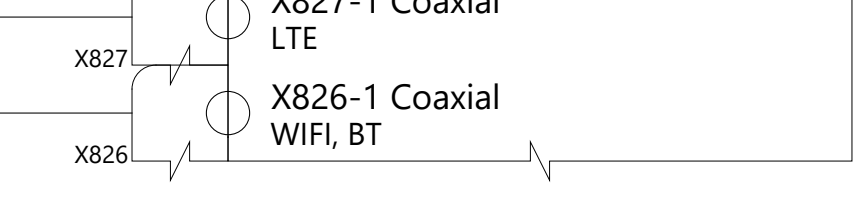

Center Display
J

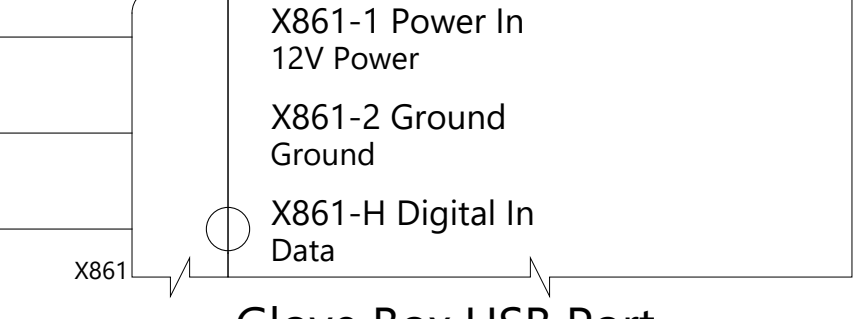

Glove Box USB Port
Z



LHD
Autopilot ECU (LHD)
W,J,B

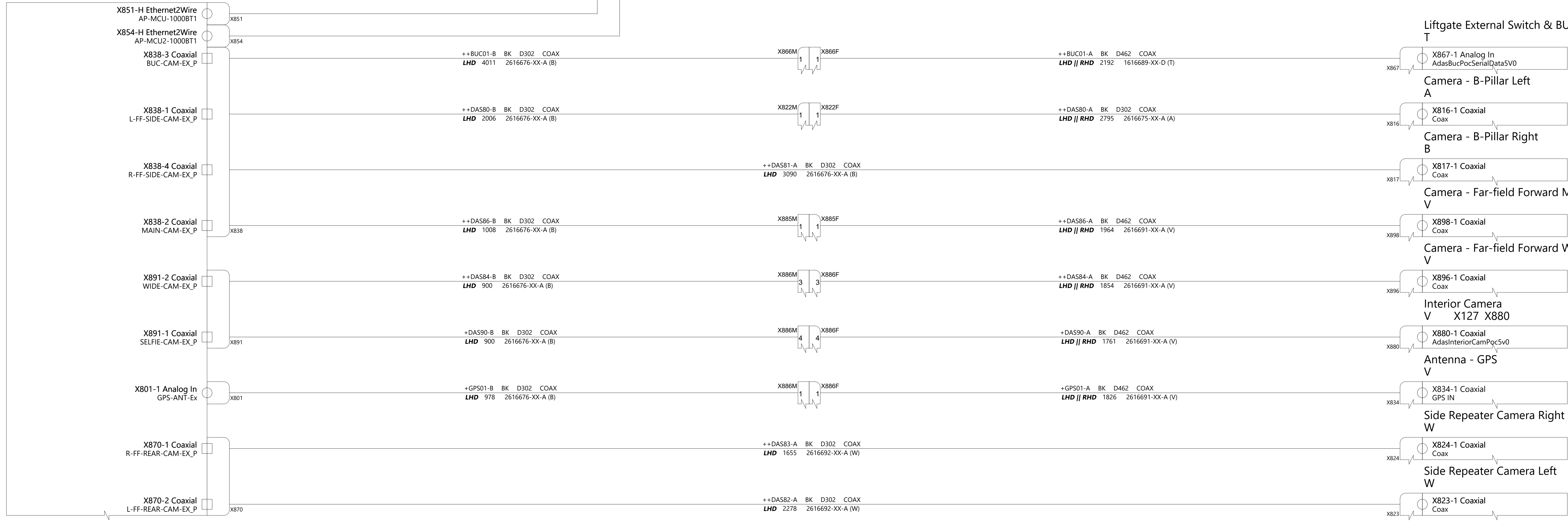

Liftgate External Switch & BUC
T

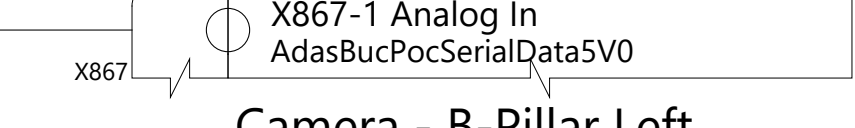

Camera - B-Pillar Left
A

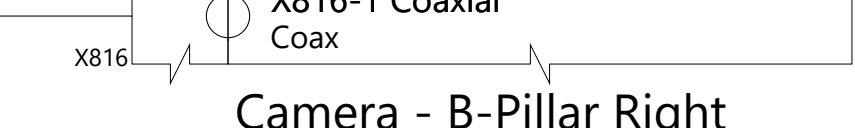

Camera - B-Pillar Right
B



Camera - Far-field Forward Main
V



Camera - Far-field Forward Wide
V



Interior Camera
V X127 X880



Antenna - GPS
V

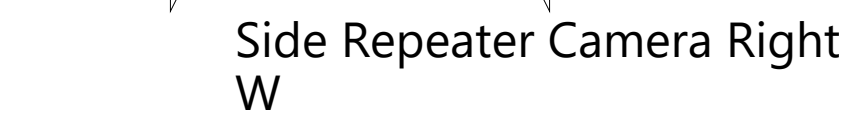

Side Repeater Camera Right
W

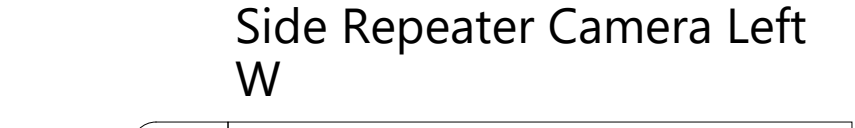

Side Repeater Camera Left
W

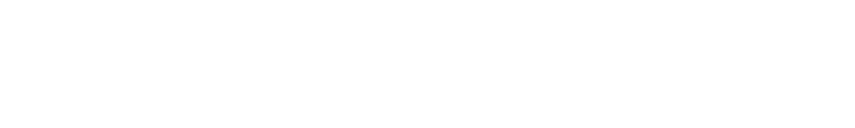

RADIO
Radio Tuner
T

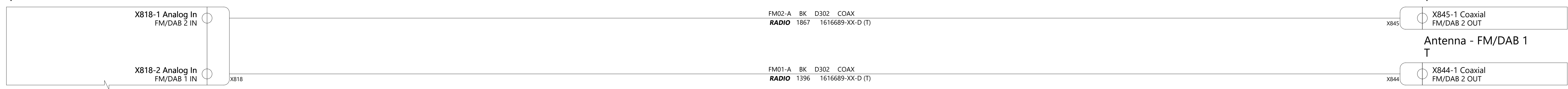

Antenna - FM/DAB 2
T

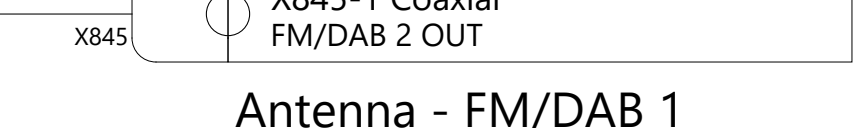

Antenna - FM/DAB 1
T

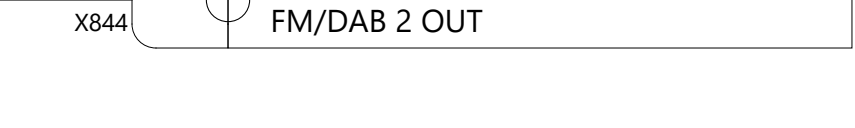

THE INFORMATION CONTAINED HEREIN IS DEEMED TO BE CONFIDENTIAL, PROPRIETARY, AND A TRADE SECRET OF TESLA MOTORS. THIS INFORMATION MAY NOT BE USED, REPRODUCED, OR DISCLOSED AS THE DIRECT OR INDIRECT BASIS FOR THE DEVELOPMENT, MANUFACTURE, OR SALE OF PROCESSES OR PRODUCTS WITHOUT THE EXPRESSED WRITTEN CONSENT OF TESLA MOTORS.

DRAWN	CHECKED	APPROVED
MATERIAL AS SPECIFIED	FINISHING AS SPECIFIED	SCALE NONE
PART NAME RF/Special Cables		
PART NUMBER	REV	SHEET
	1	42 OF 55
		SIZE A0

RHD
MCU (RHD)
W,A,B



RHD
Autopilot ECU (RHD)
W,J,B

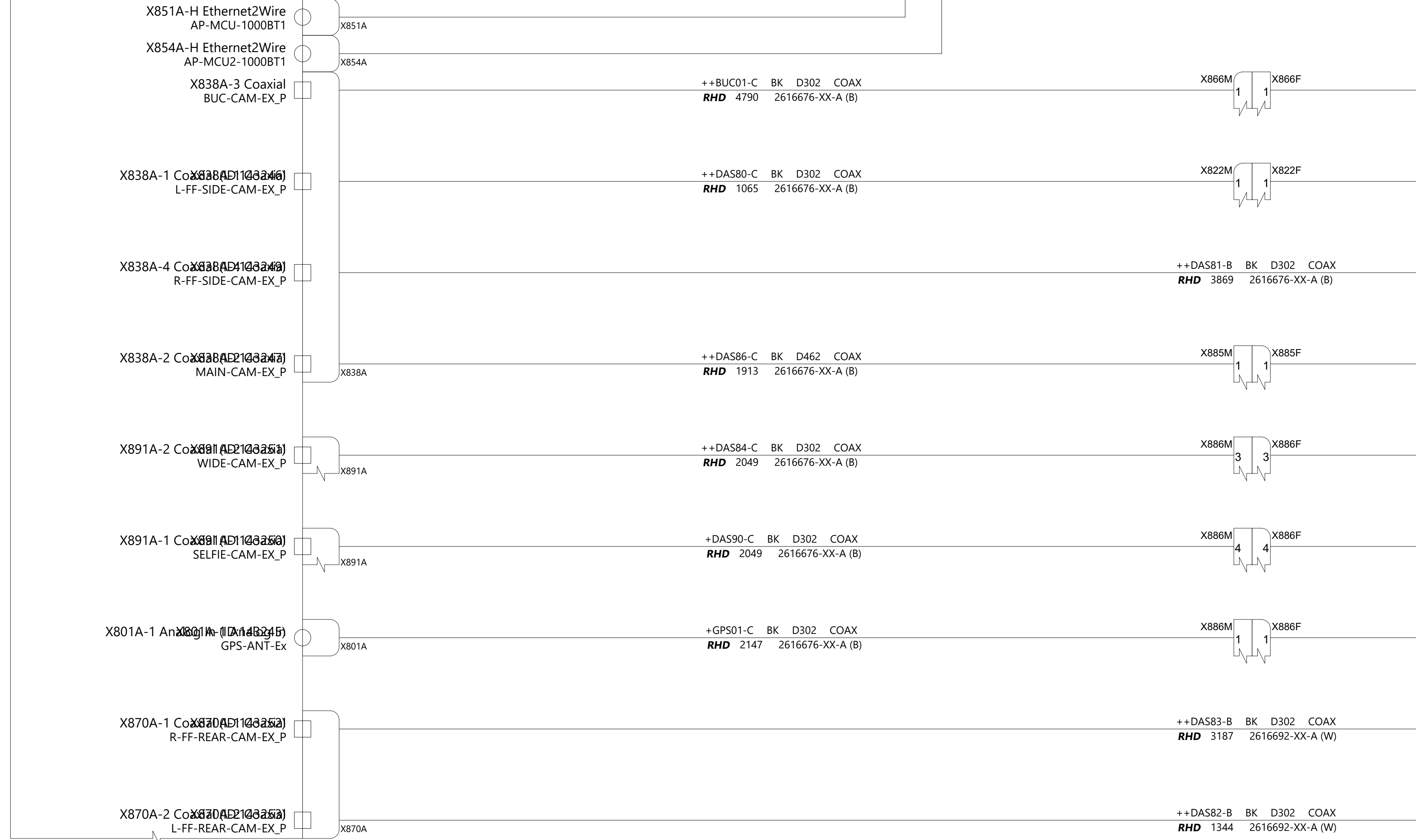

Antenna - WiFi & LTE RH
B

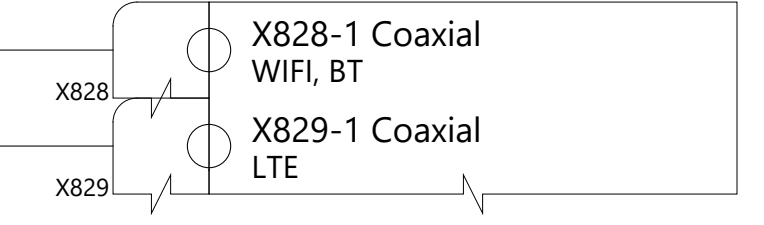

Antenna - WiFi & LTE LH
B

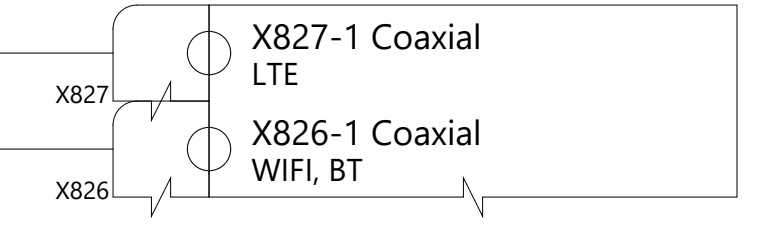

Center Display
J

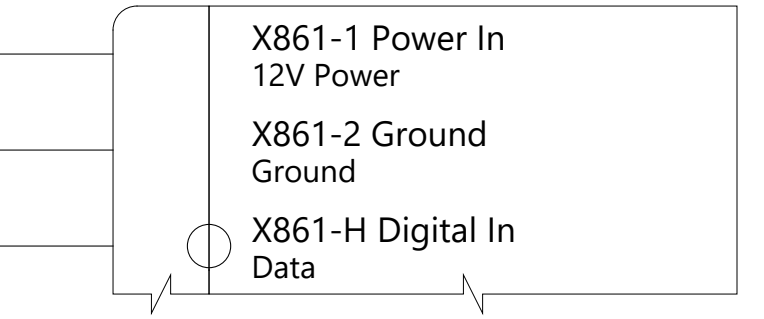

Glove Box USB Port
Z

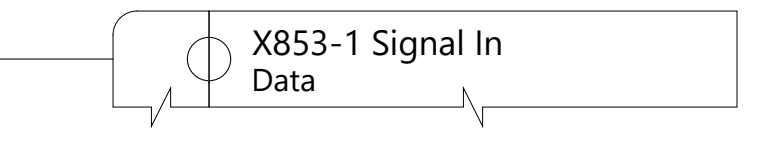

Liftgate External Switch & BUC
T

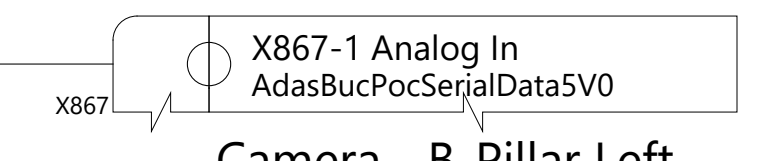

Camera - B-Pillar Left
A

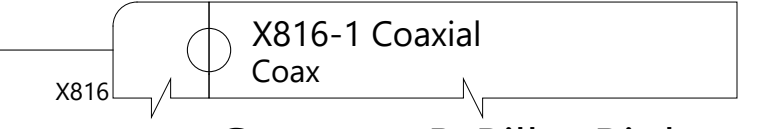

Camera - B-Pillar Right
B

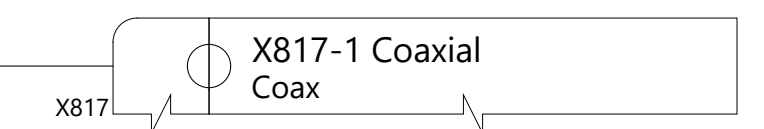

Camera - Far-field Forward Main
V

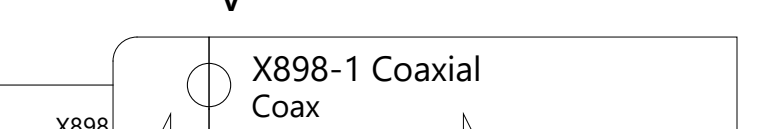

Camera - Far-field Forward Wide
V

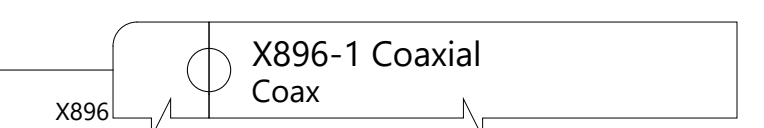

Interior Camera
V X127 X880



Antenna - GPS
V

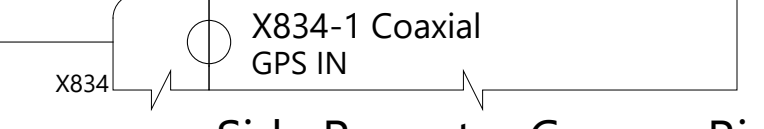

Side Repeater Camera Right
W

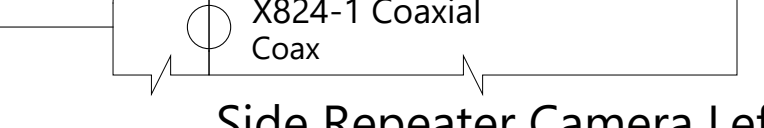

Side Repeater Camera Left
W

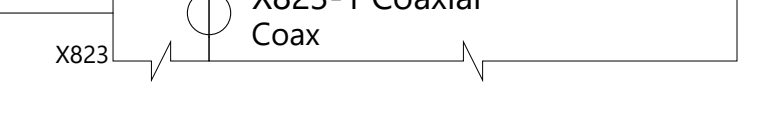

THE INFORMATION CONTAINED HEREIN IS DEEMED TO BE CONFIDENTIAL, PROPRIETARY, AND A TRADE SECRET OF TESLA MOTORS. THIS INFORMATION MAY NOT BE USED, REPRODUCED, OR DISCLOSED AS THE DIRECT OR INDIRECT BASIS FOR THE DEVELOPMENT, MANUFACTURE, OR SALE OF PROCESSES OR PRODUCTS WITHOUT THE EXPRESSED WRITTEN CONSENT OF TESLA MOTORS.

DRAWN	CHECKED	APPROVED
-------	---------	----------

MATERIAL AS SPECIFIED	FINISHING AS SPECIFIED	SCALE NONE
--------------------------	---------------------------	---------------

PART NAME
RF/Special Cables, RHD

PART NUMBER	REV	SHEET	SIZE
	1	43 of 55	A0

HORN
Horn - Low Tone
W



HORN
Horn - High Tone
W



Emergency Frunk Release Switch
L



Homelink ECU
W



LHD
Glass Heater - Windshield (LHD)
W

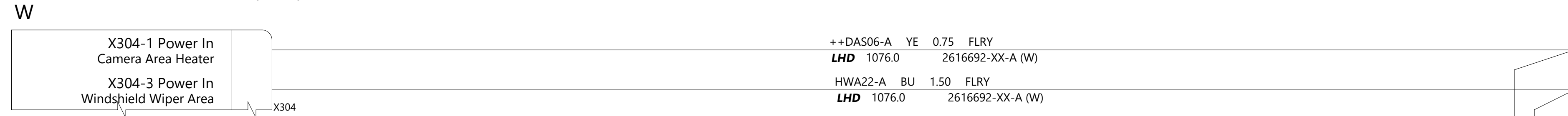

RHD
Glass Heater - Windshield (RHD)
W

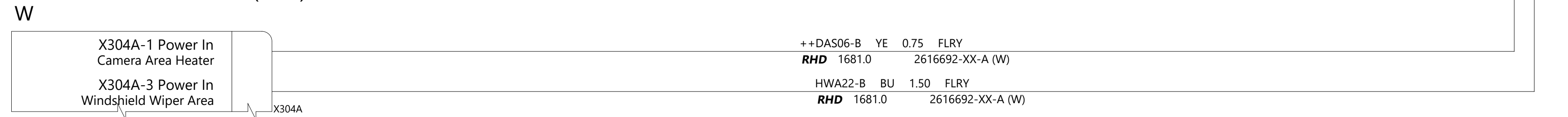

Frunk Access Post
F



AWD
Drive Inverter Front & Resolver
N X093 X094



AWD
Drive Inverter Front & Resolver
N X093 X094



AWD
Drive Unit Oil Pump Front
N



Frunk Latch
L

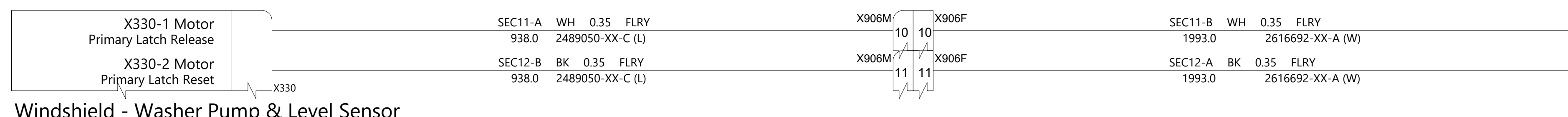

Windshield - Washer Pump & Level Sensor
W



LHD
MCU (LHD)
W,B

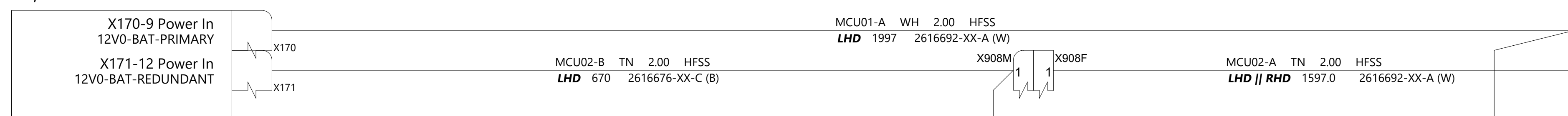

RHD
MCU (RHD)
W,A,B

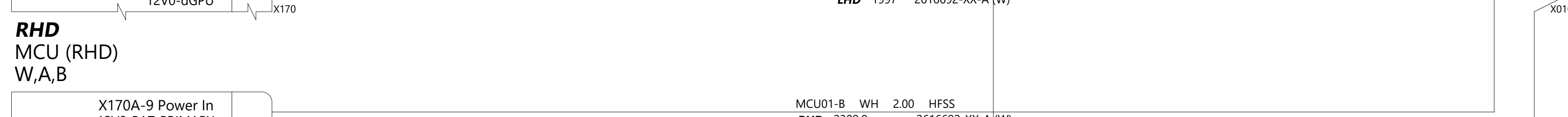

Body Controller Front
W,U X021 X012 X011 X010 X015 X014

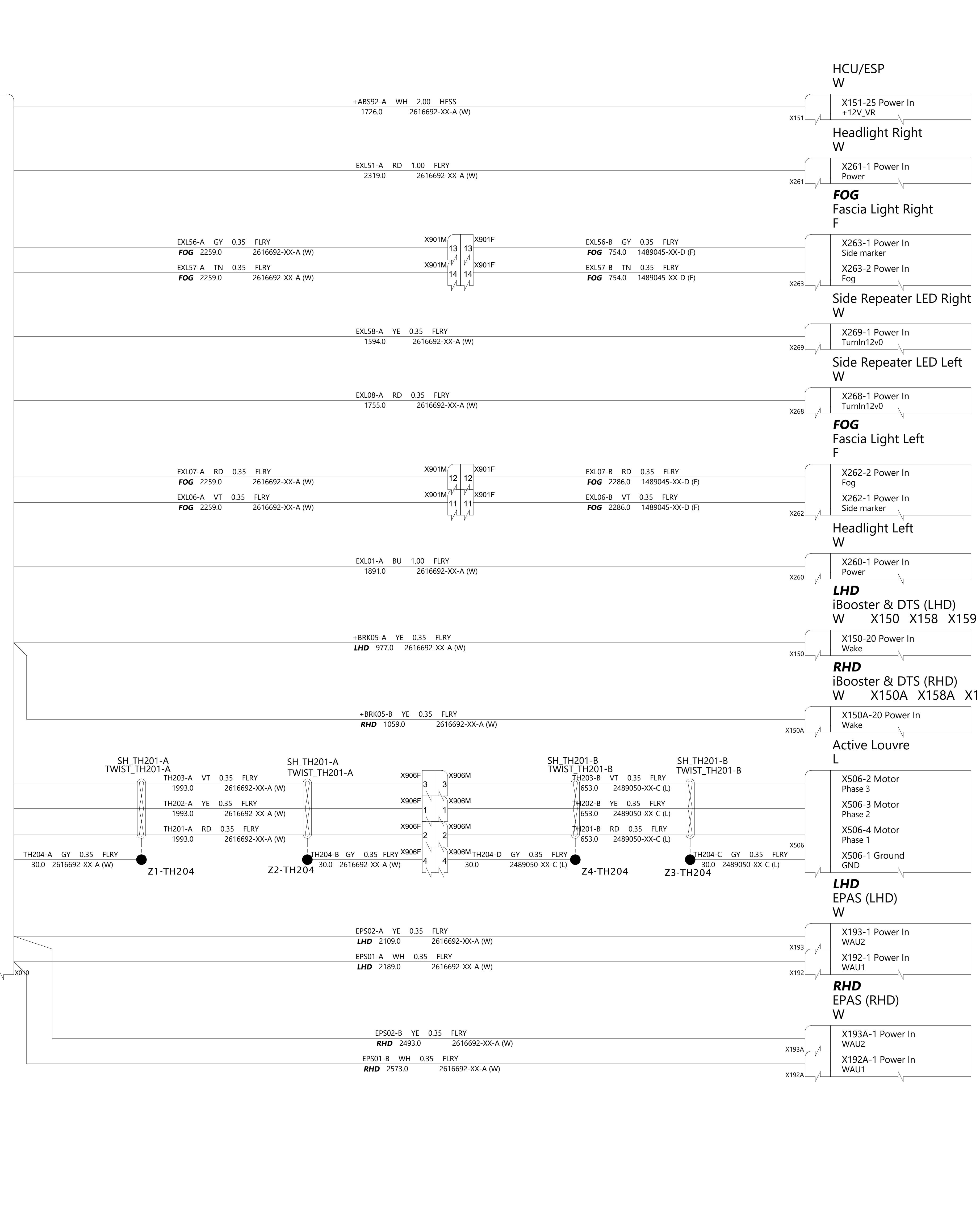
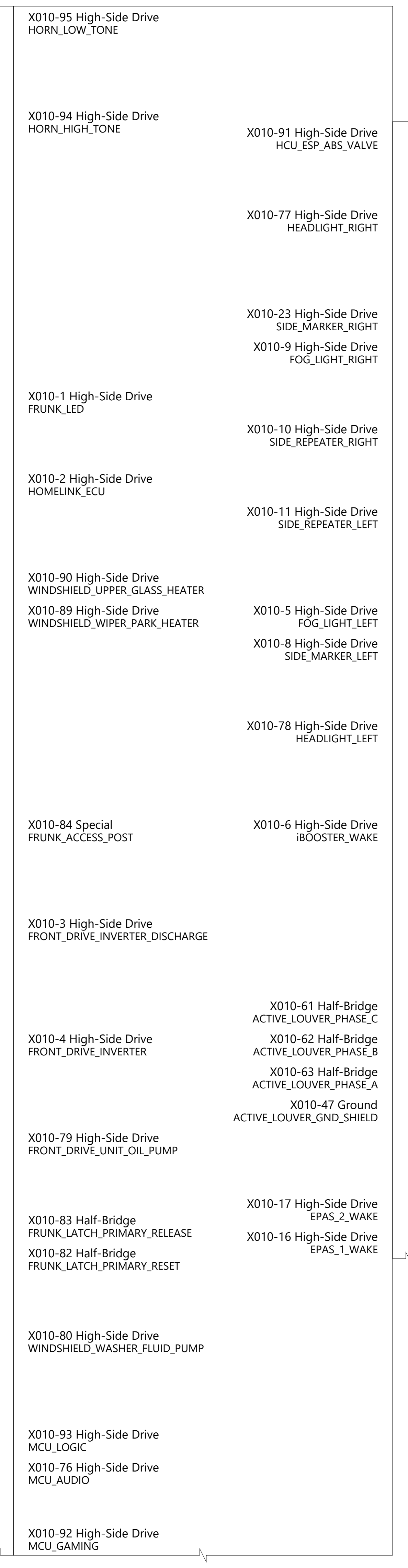

THE INFORMATION CONTAINED HEREIN IS DEEMED TO BE CONFIDENTIAL, PROPRIETARY, AND A TRADE SECRET OF TESLA MOTORS. THIS INFORMATION MAY NOT BE USED, REPRODUCED, OR DISCLOSED AS THE DIRECT OR INDIRECT BASIS FOR THE DEVELOPMENT, MANUFACTURE, OR SALE OF PROCESSES OR PRODUCTS WITHOUT THE EXPRESSED WRITTEN CONSENT OF TESLA MOTORS.

DRAWN	CHECKED	APPROVED
MATERIAL AS SPECIFIED	FINISHING AS SPECIFIED	SCALE NONE
PART NAME Sample-Power Distribution - VCFront 1/2		
PART NUMBER	REV	SHEET
	1	44 OF 55
		SIZE A0

Body Controller Left
A,D,J,W X036 X030A X030B X031 X039 X037 X033A X033B X032 X035 X038

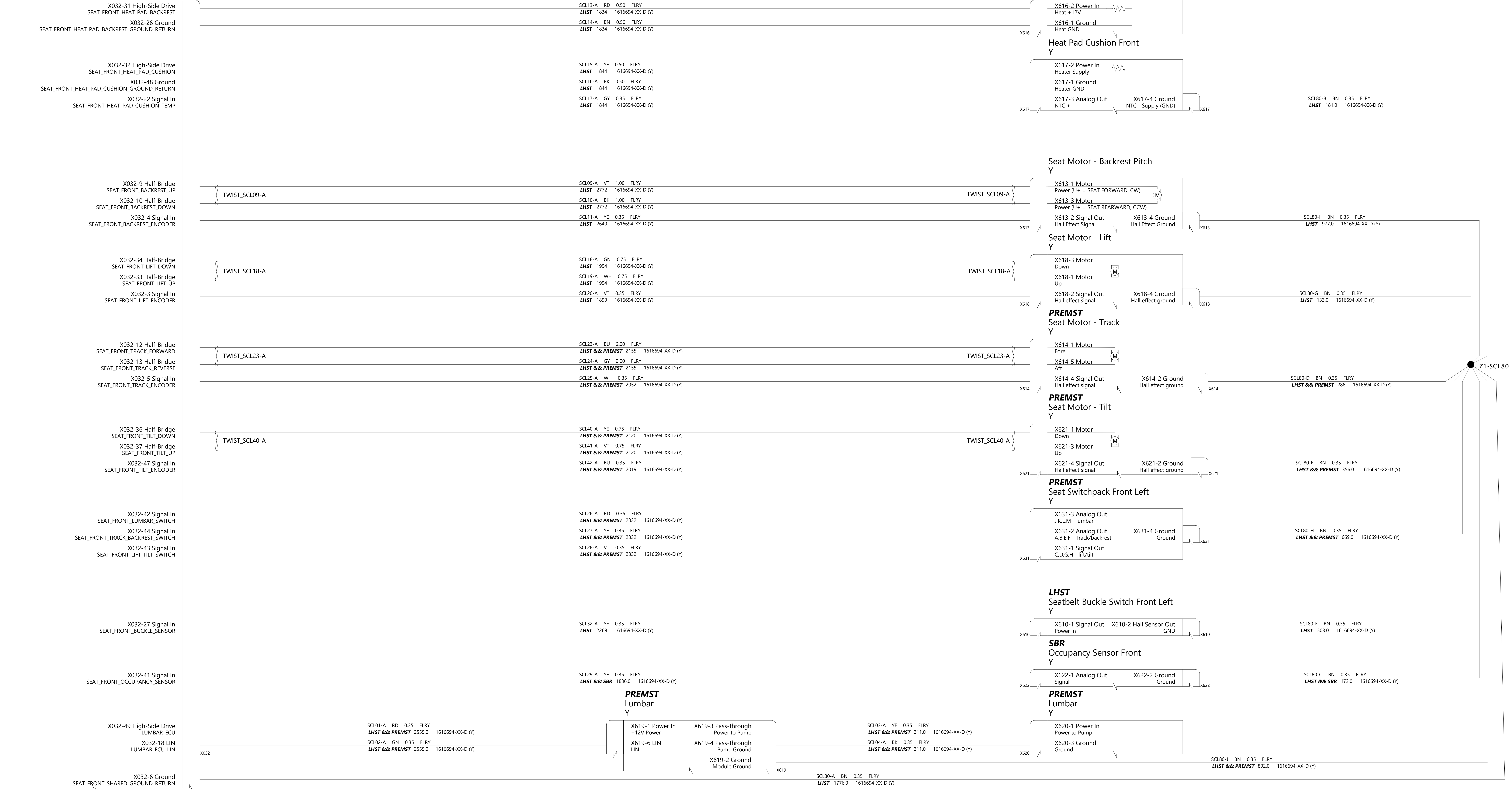

THE INFORMATION CONTAINED HEREIN IS DEEMED TO BE CONFIDENTIAL, PROPRIETARY, AND A TRADE SECRET OF TESLA MOTORS. THIS INFORMATION MAY NOT BE USED, REPRODUCED, OR DISCLOSED AS THE DIRECT OR INDIRECT BASIS FOR THE DEVELOPMENT, MANUFACTURE, OR SALE OF PROCESSES OR PRODUCTS WITHOUT THE EXPRESSED WRITTEN CONSENT OF TESLA MOTORS.

DRAWN	CHECKED	APPROVED
-------	---------	----------

MATERIAL AS SPECIFIED	FINISHING AS SPECIFIED	SCALE NONE
--------------------------	---------------------------	---------------

PART NAME
Seats Front Left

PART NUMBER	REV	SHEET	SIZE
	1	45 OF 55	A0

Body Controller Right
B,P,I,W X056 X050A X050B X051 X059 X057 X053A X053B X052 X055 X058 X060

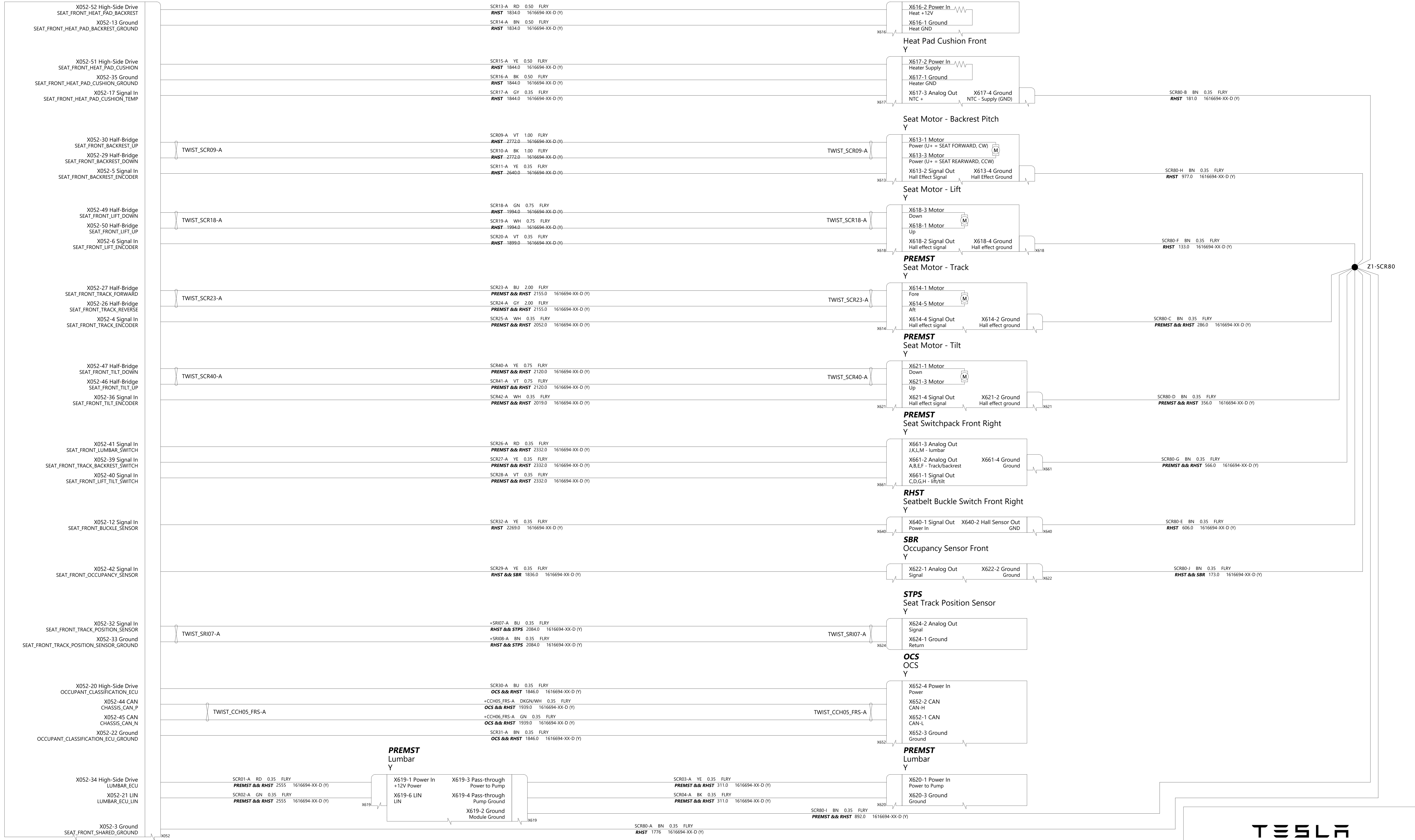

THE INFORMATION CONTAINED HEREIN IS DEEMED TO BE CONFIDENTIAL, PROPRIETARY, AND A TRADE SECRET OF TESLA MOTORS. THIS INFORMATION MAY NOT BE USED, REPRODUCED, OR DISCLOSED AS THE DIRECT OR INDIRECT BASIS FOR THE DEVELOPMENT, MANUFACTURE, OR SALE OF PROCESSES OR PRODUCTS WITHOUT THE EXPRESSED WRITTEN CONSENT OF TESLA MOTORS.

DRAWN	CHECKED	APPROVED
MATERIAL AS SPECIFIED	FINISHING AS SPECIFIED	SCALE NONE
PART NAME Seats Front Right		
PART NUMBER	REV	SHEET
	1	46 OF 55
		SIZE A0

Body Controller Right
B,P,I,W X050A X050B X051 X059 X057 X053A X053B X052 X055 X058 X060

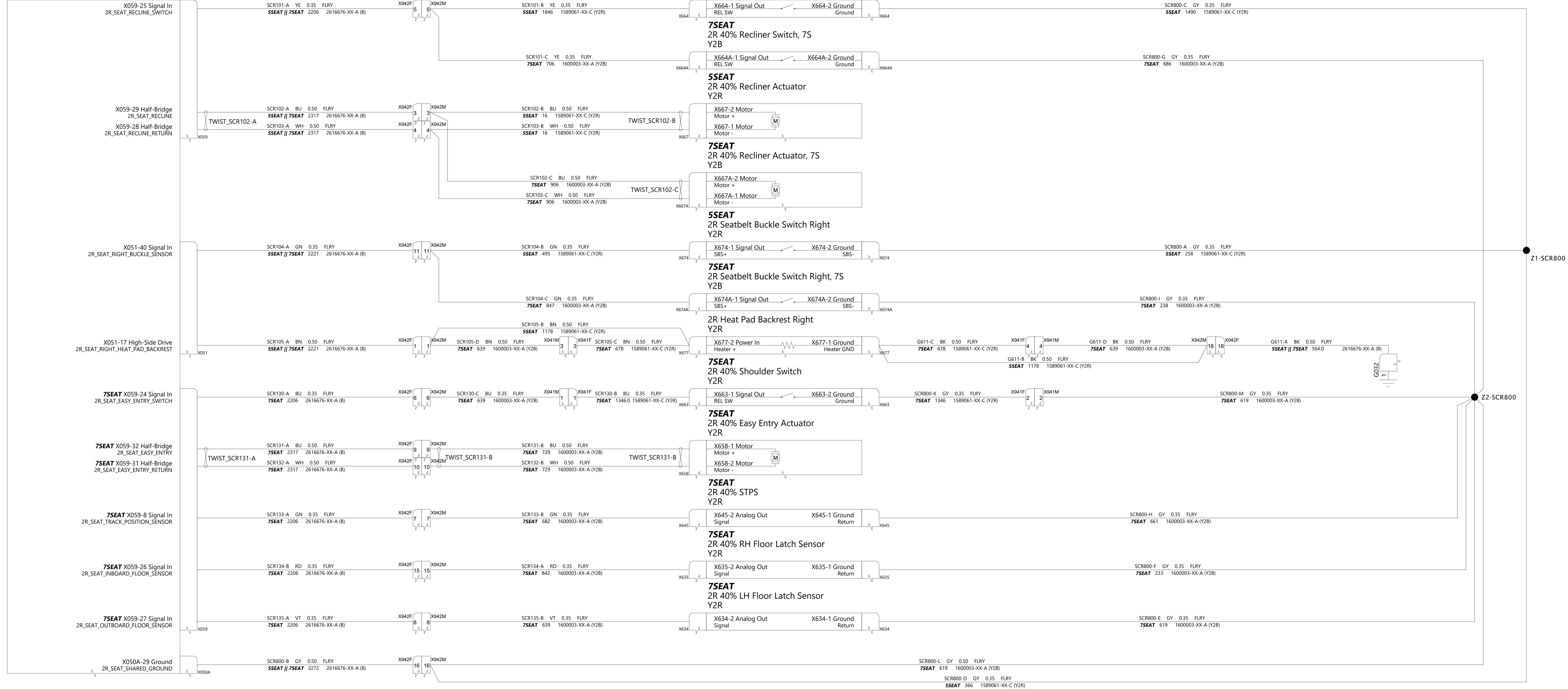

THE INFORMATION CONTAINED HEREIN IS DEEMED TO BE CONFIDENTIAL, PROPRIETARY, AND A TRADE SECRET OF TESLA MOTORS. THIS INFORMATION MAY NOT BE USED, REPRODUCED, OR DISCLOSED AS THE DIRECT OR INDIRECT BASIS FOR THE DEVELOPMENT, MANUFACTURE, OR SALE OF PROCESSES OR PRODUCTS WITHOUT THE EXPRESSED WRITTEN CONSENT OF TESLA MOTORS.

DRAWN	CHECKED	APPROVED
-------	---------	----------

MATERIAL AS SPECIFIED	FINISHING AS SPECIFIED	SCALE NONE
--------------------------	---------------------------	---------------

PART NAME
Seats Second Row 40%

PART NUMBER	REV	SHEET	SIZE
	1	47 OF 55	A0

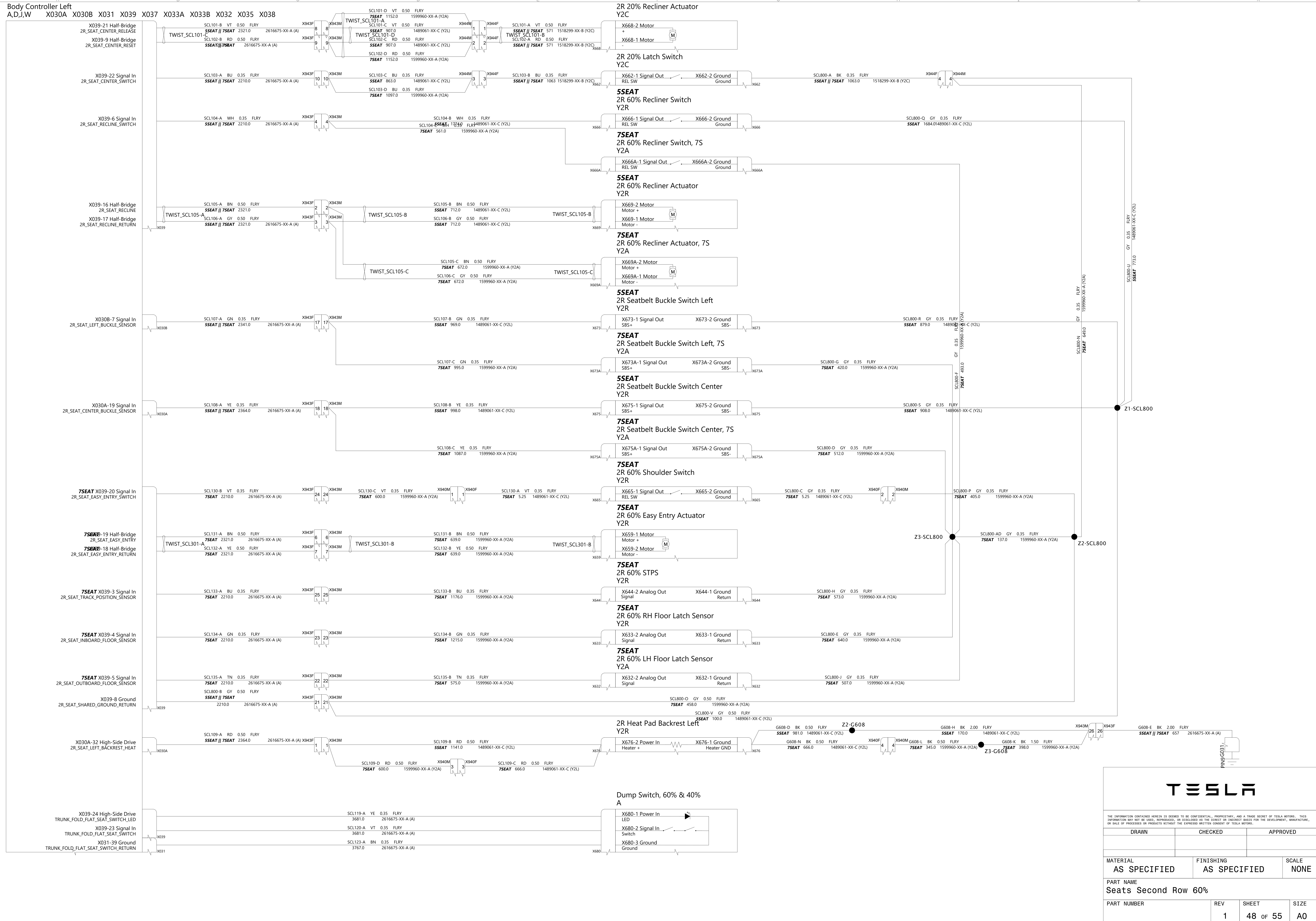

THE INFORMATION CONTAINED HEREIN IS DEEMED TO BE CONFIDENTIAL, PROPRIETARY, AND A TRADE SECRET OF TESLA MOTORS. THIS INFORMATION MAY NOT BE USED, REPRODUCED, OR DISCLOSED AS THE DIRECT OR INDIRECT BASIS FOR THE DEVELOPMENT, MANUFACTURE, OR SALE OF PROCESSES OR PRODUCTS WITHOUT THE EXPRESSED WRITTEN CONSENT OF TESLA MOTORS.

DRAWN	CHECKED	APPROVED

MATERIAL AS SPECIFIED	FINISHING AS SPECIFIED	SCALE NONE

PART NAME
Seats Second Row 60%

PART NUMBER	REV	SHEET	SIZE
	1	48 OF 55	A0

Body Controller Left
A,D,J,W X030A X030B X031 X039 X037 X033A X033B X032 X035 X038

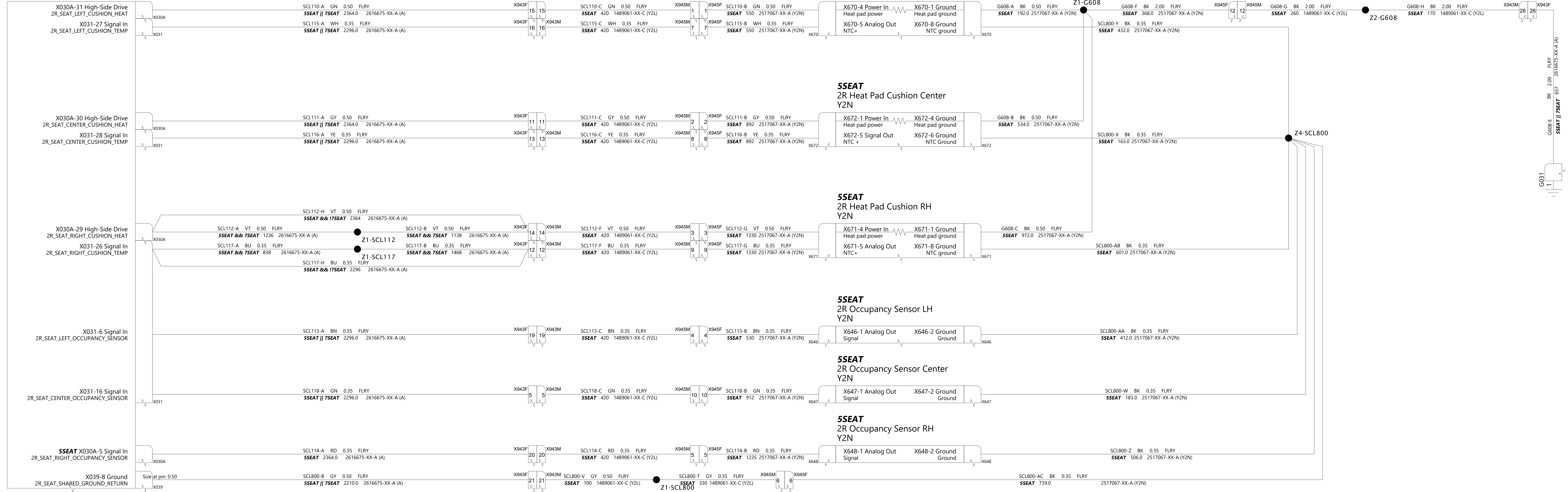

THE INFORMATION CONTAINED HEREIN IS DEEMED TO BE CONFIDENTIAL, PROPRIETARY, AND A TRADE SECRET OF TESLA MOTORS. THIS INFORMATION MAY NOT BE USED, REPRODUCED, OR DISCLOSED AS THE DIRECT OR INDIRECT BASIS FOR THE DEVELOPMENT, MANUFACTURE, OR SALE OF PROCESSES OR PRODUCTS WITHOUT THE EXPRESSED WRITTEN CONSENT OF TESLA MOTORS.

DRAWN	CHECKED	APPROVED
-------	---------	----------

MATERIAL AS SPECIFIED	FINISHING AS SPECIFIED	SCALE NONE
--------------------------	---------------------------	---------------

PART NAME
Seats Second Row Cushion 5-Seater

PART NUMBER	REV	SHEET	SIZE
	1	49 OF 55	A0

Body Controller Left
A,D,J,W X030A X030B X031 X039 X037 X033A X033B X032 X035 X038

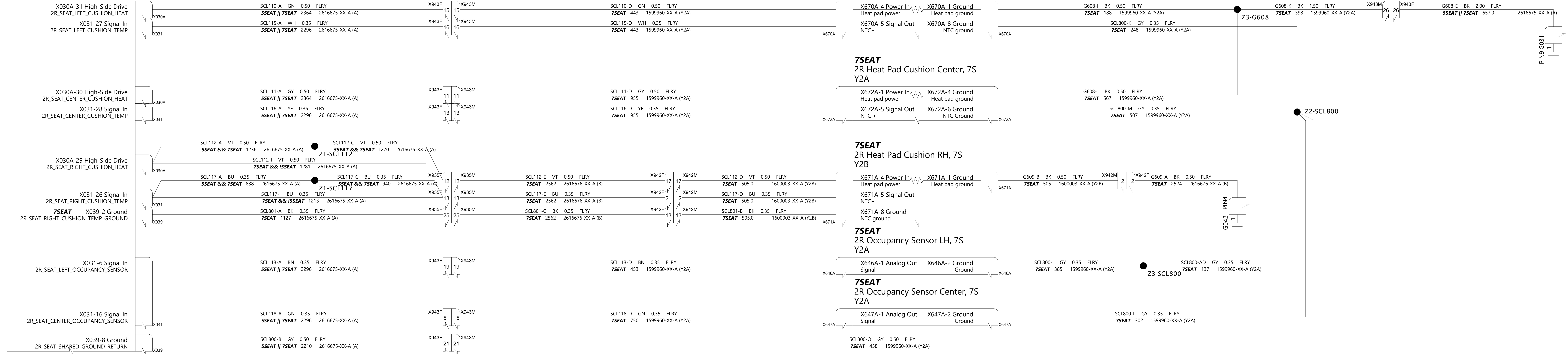

Body Controller Right
B,P,J,W X050A X050B X051 X059 X053A X053B X052 X055 X058 X060

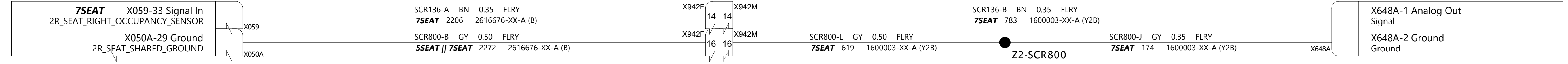

THE INFORMATION CONTAINED HEREIN IS DEEMED TO BE CONFIDENTIAL, PROPRIETARY, AND A TRADE SECRET OF TESLA MOTORS. THIS INFORMATION MAY NOT BE USED, REPRODUCED, OR DISCLOSED AS THE DIRECT OR INDIRECT BASIS FOR THE DEVELOPMENT, MANUFACTURE, OR SALE OF PROCESSES OR PRODUCTS WITHOUT THE EXPRESSED WRITTEN CONSENT OF TESLA MOTORS.

DRAWN	CHECKED	APPROVED
MATERIAL AS SPECIFIED	FINISHING AS SPECIFIED	SCALE NONE
PART NAME Seats Second Row Cushion 7-Seater		
PART NUMBER	REV 1	SHEET 50 OF 55
		SIZE A0

Body Controller Right
B,P,I,W X056 X050A X050B X051 X059 X057 X053A X053B X052 X055 X058 X060

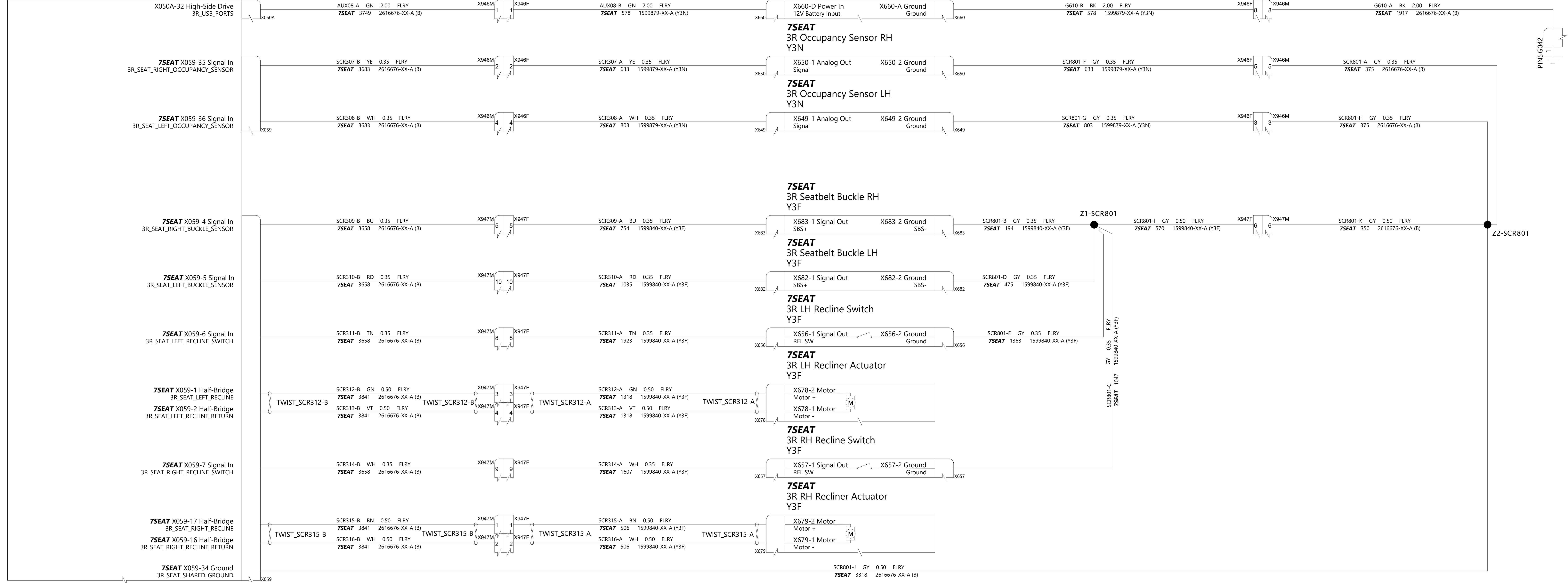

THE INFORMATION CONTAINED HEREIN IS DEEMED TO BE CONFIDENTIAL, PROPRIETARY, AND A TRADE SECRET OF TESLA MOTORS. THIS INFORMATION MAY NOT BE USED, REPRODUCED, OR DISCLOSED AS THE DIRECT OR INDIRECT BASIS FOR THE DEVELOPMENT, MANUFACTURE, OR SALE OF PROCESSES OR PRODUCTS WITHOUT THE EXPRESSED WRITTEN CONSENT OF TESLA MOTORS.

DRAWN	CHECKED	APPROVED	
MATERIAL AS SPECIFIED	FINISHING AS SPECIFIED	SCALE NONE	
PART NAME Seats Third Row			
PART NUMBER	REV	SHEET	SIZE
	1	51 of 55	A0

Body Controller Left
A,D,J,W X030A X030B X031 X039 X037 X033A X033B X032 X035 X038

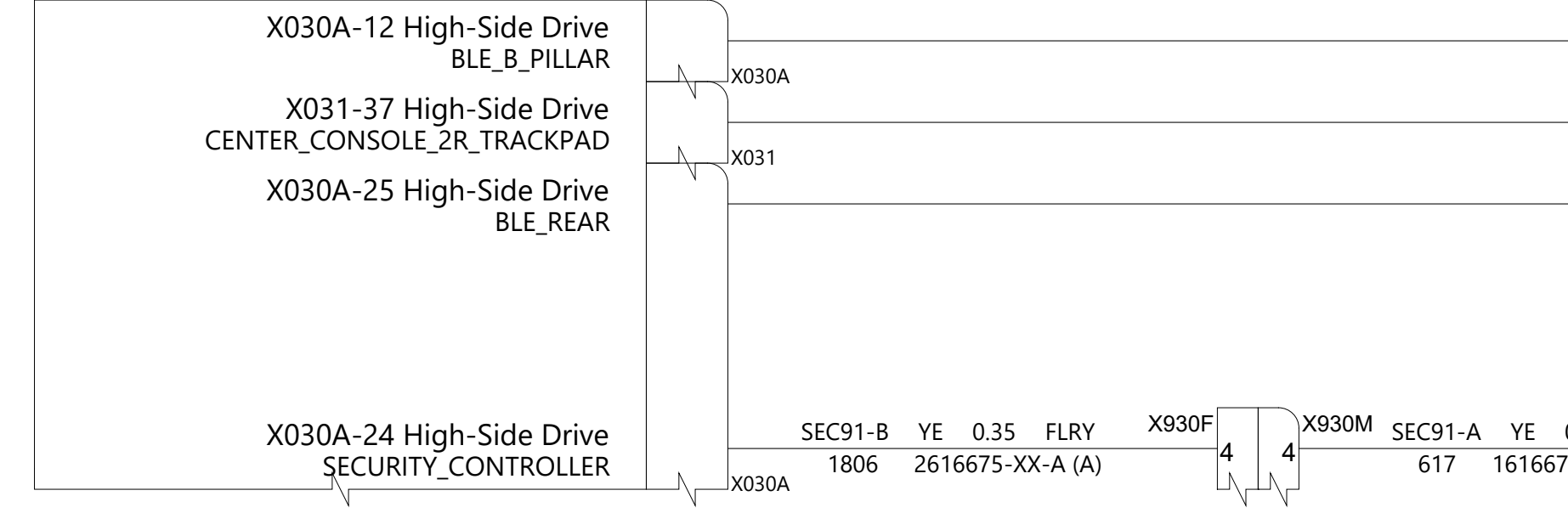

Security Controller C

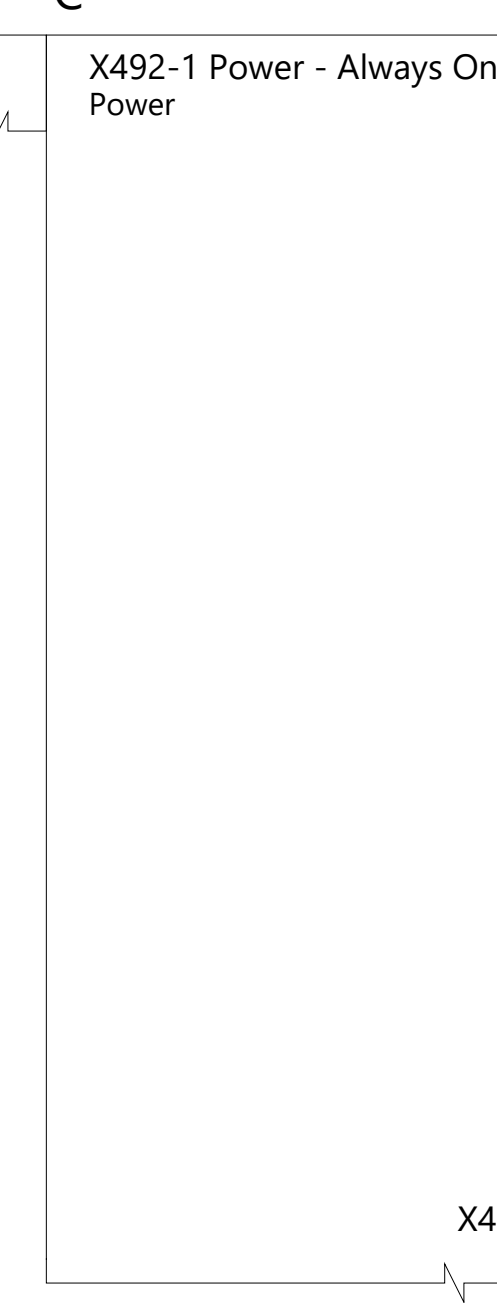

Body Controller Right
B,P,J,W X050A X050B X051 X059 X057 X053A X053B X052 X055 X058 X060

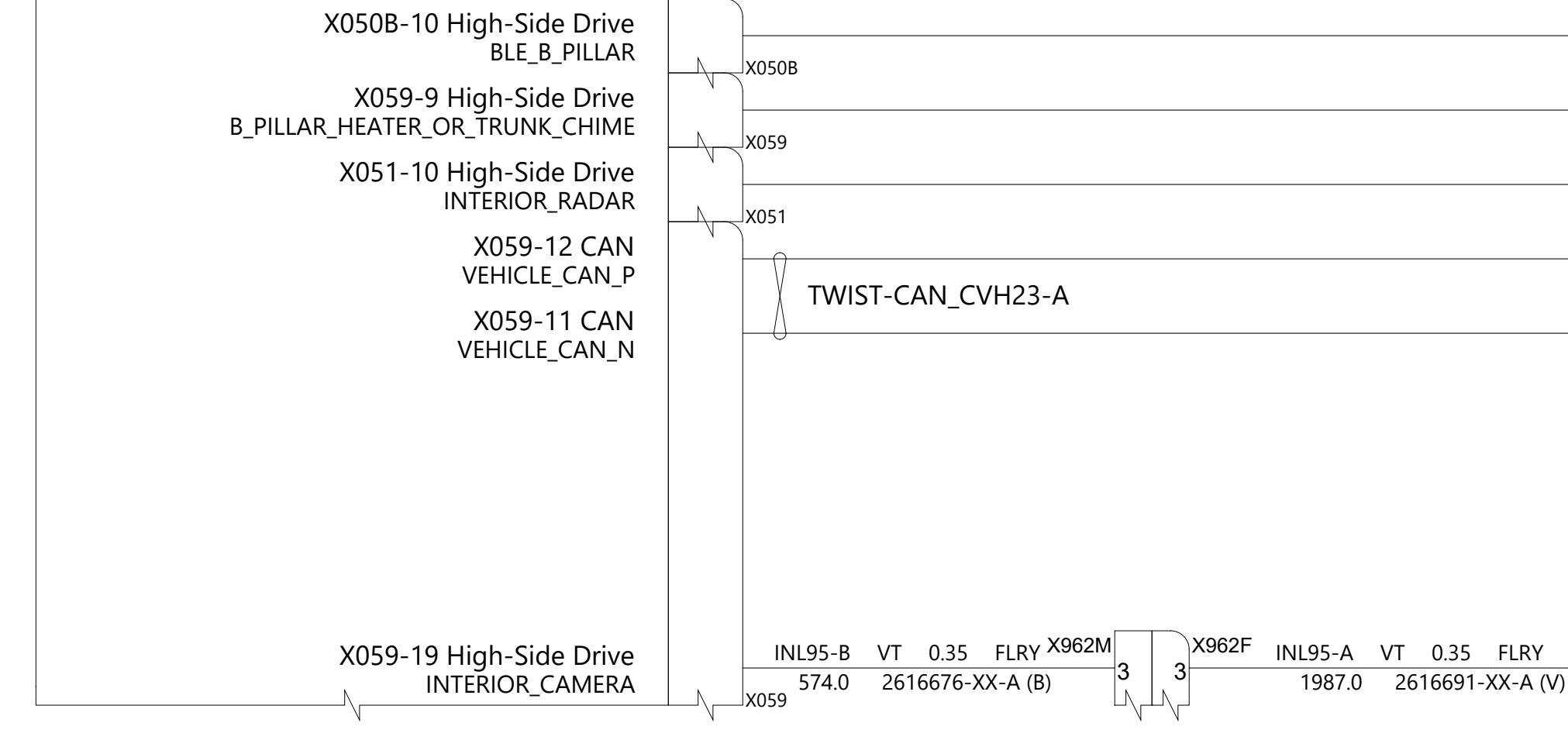

Interior Camera V
X127 X880

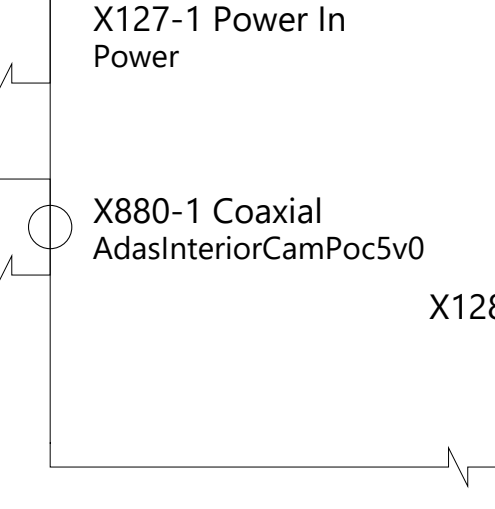

HORN
Horn - High Tone W

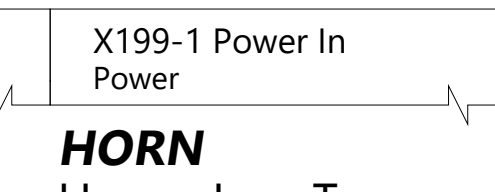

HORN
Horn - Low Tone W

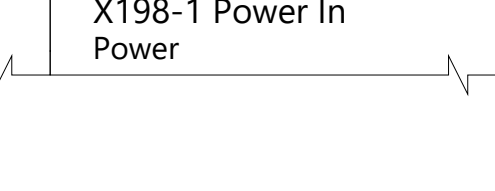

Body Controller Front
W,U X012 X011 X010 X015 X014

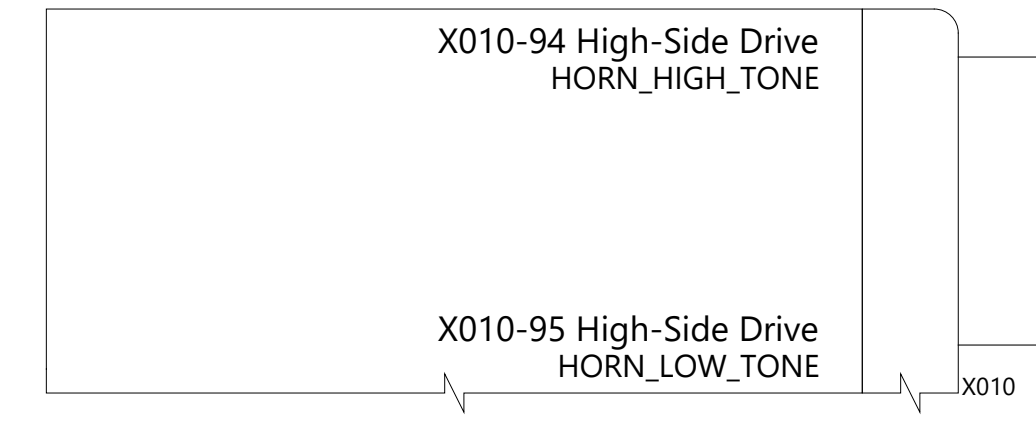

BLE Left B-Pillar A

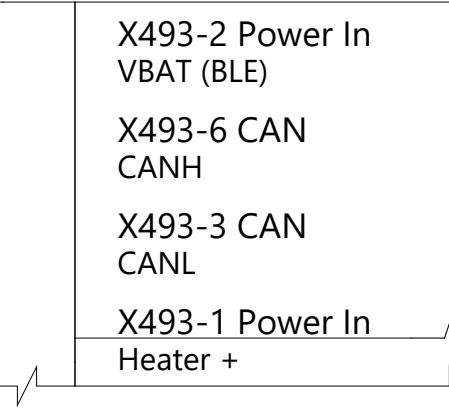

BLE Rear A

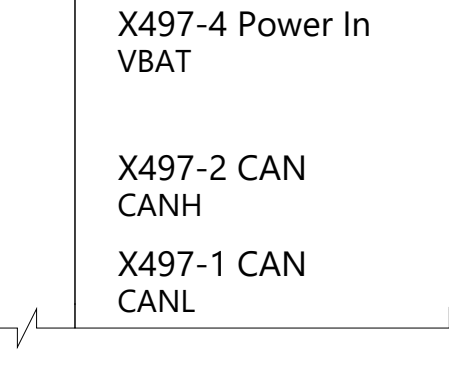

BLE Right B-Pillar B

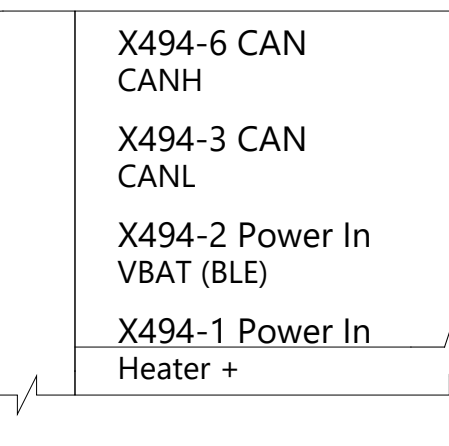

Radar Interior B

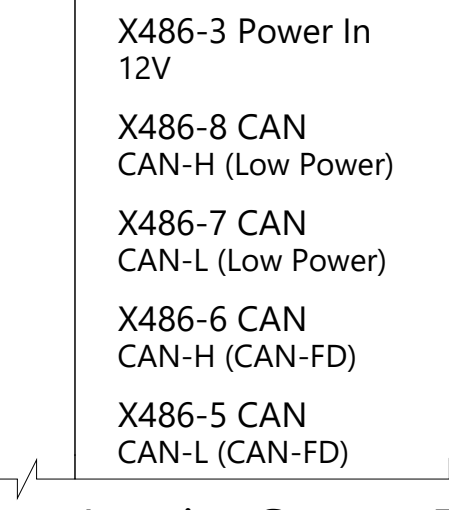

Interior Camera Fan Fan Pigtail

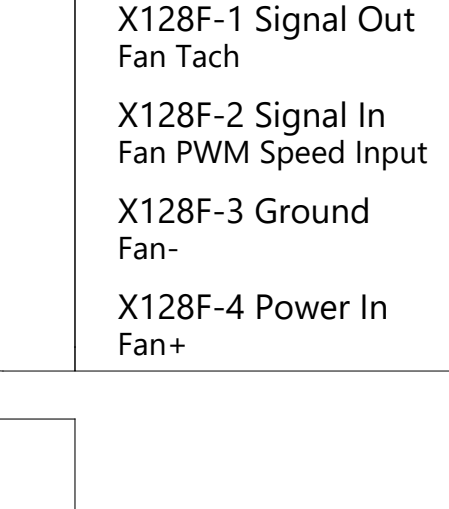

THE INFORMATION CONTAINED HEREIN IS DEEMED TO BE CONFIDENTIAL, PROPRIETARY, AND A TRADE SECRET OF TESLA MOTORS. THIS INFORMATION MAY NOT BE USED, REPRODUCED, OR DISCLOSED AS THE DIRECT OR INDIRECT BASIS FOR THE DEVELOPMENT, MANUFACTURE, OR SALE OF PROCESSES OR PRODUCTS WITHOUT THE EXPRESSED WRITTEN CONSENT OF TESLA MOTORS.

DRAWN	CHECKED	APPROVED
-------	---------	----------

MATERIAL AS SPECIFIED	FINISHING AS SPECIFIED	SCALE NONE
--------------------------	---------------------------	---------------

PART NAME
Security Controls

PART NUMBER	REV	SHEET	SIZE
	1	52 OF 55	A0

Body Controller Front
W,U X021 X012 X011 X010 X015 X014

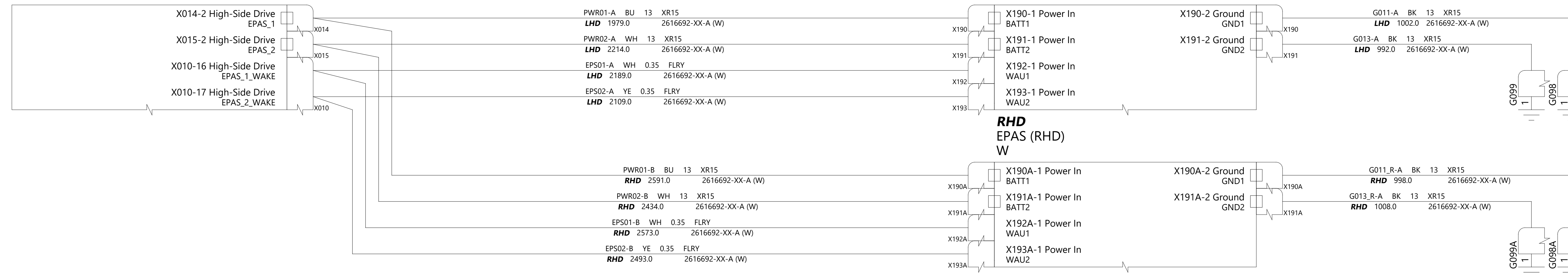

Body Controller Left
A,D,J,W X036 X030A X030B X031 X039 X037 X033A X033B X032 X035 X038

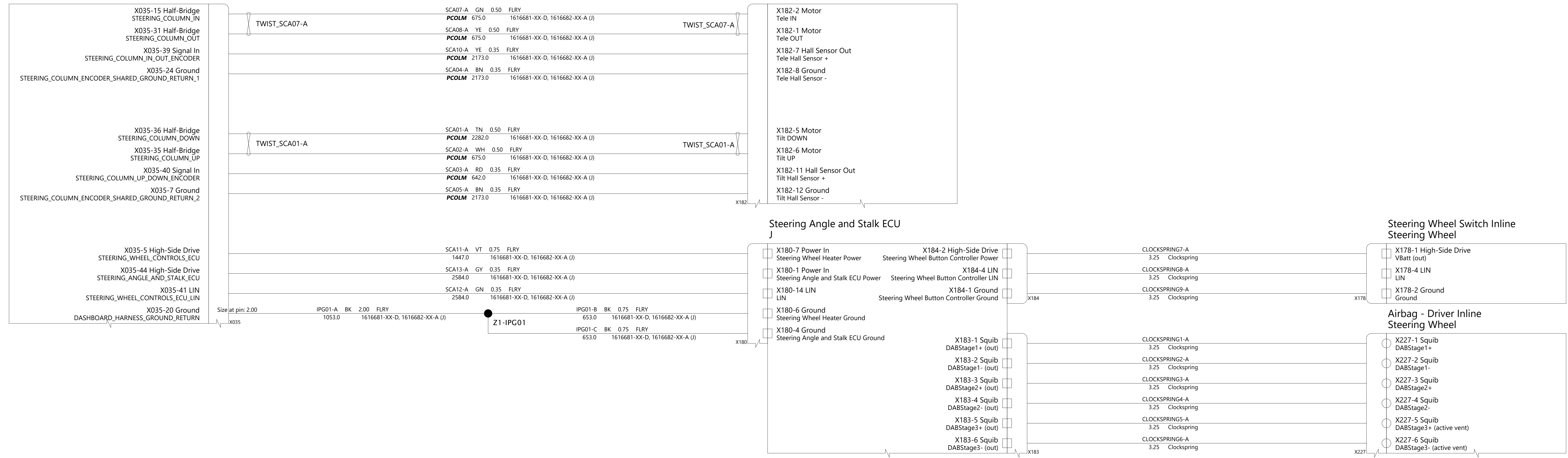

THE INFORMATION CONTAINED HEREIN IS DEEMED TO BE CONFIDENTIAL, PROPRIETARY, AND A TRADE SECRET OF TESLA MOTORS. THIS INFORMATION MAY NOT BE USED, REPRODUCED, OR DISCLOSED AS THE DIRECT OR INDIRECT BASIS FOR THE DEVELOPMENT, MANUFACTURE, OR SALE OF PROCESSES OR PRODUCTS WITHOUT THE EXPRESSED WRITTEN CONSENT OF TESLA MOTORS.

DRAWN	CHECKED	APPROVED	
MATERIAL AS SPECIFIED	FINISHING AS SPECIFIED	SCALE NONE	
PART NAME Steering			
PART NUMBER	REV	SHEET	SIZE
	1	53 OF 55	A0

Body Controller Left
A,D,J,W

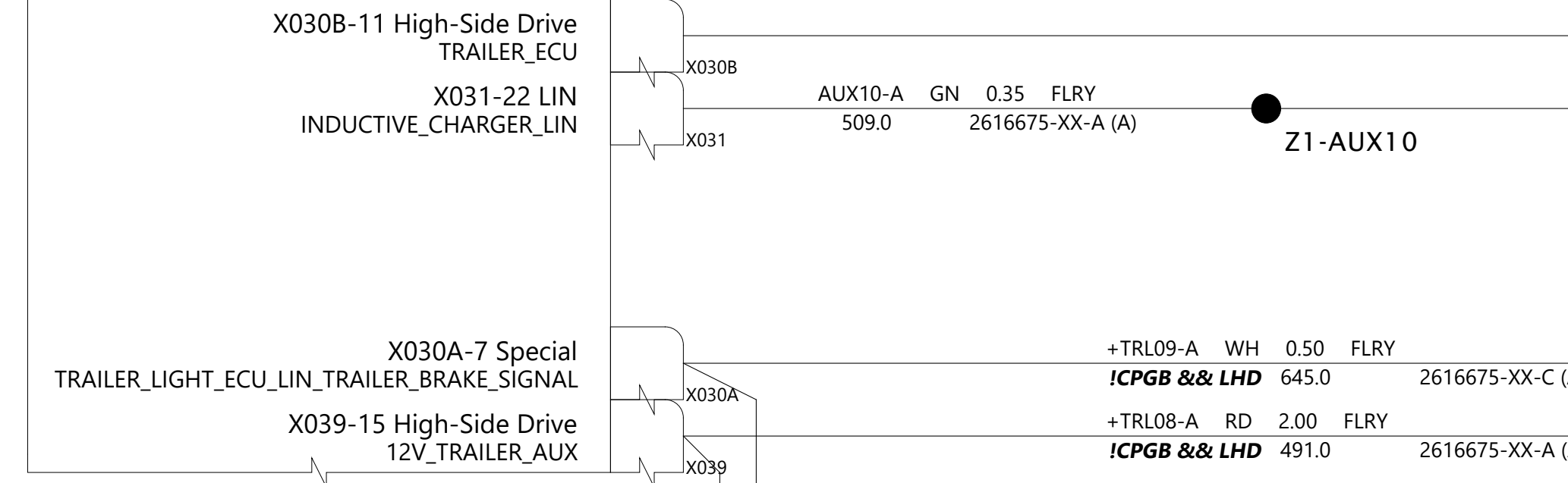

Trailer Light Controller
Trailer Jumper

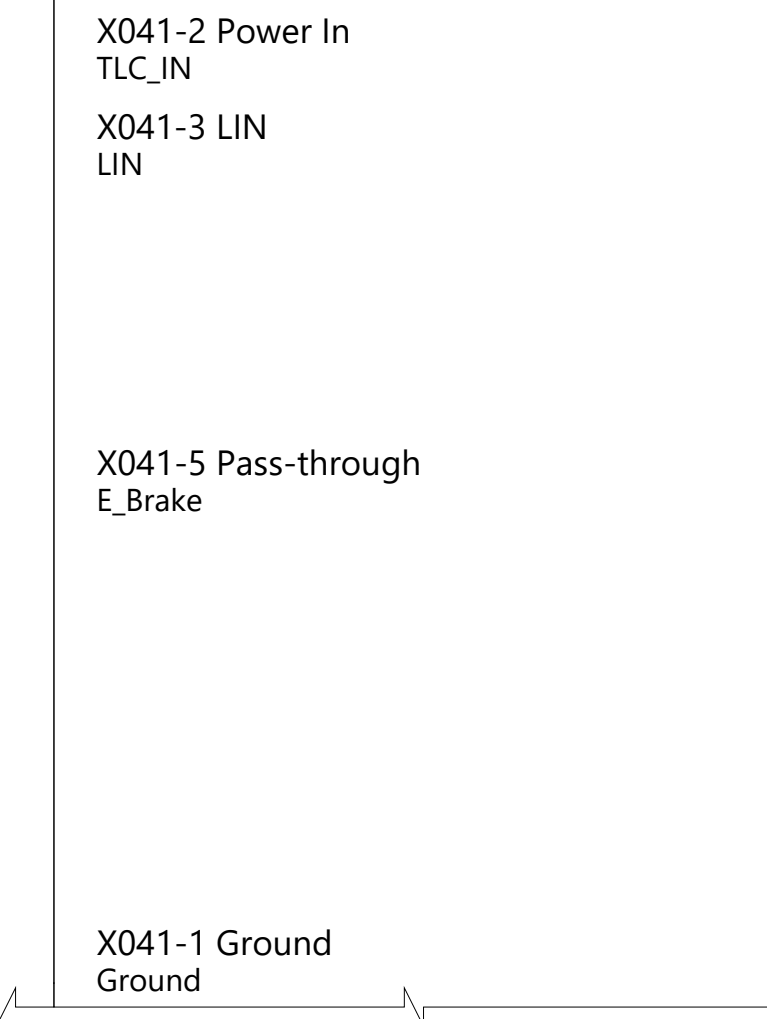

LHD && ICPGB
Trailer Brake Controller
A



RHD
Trailer Brake Controller, RHD
B

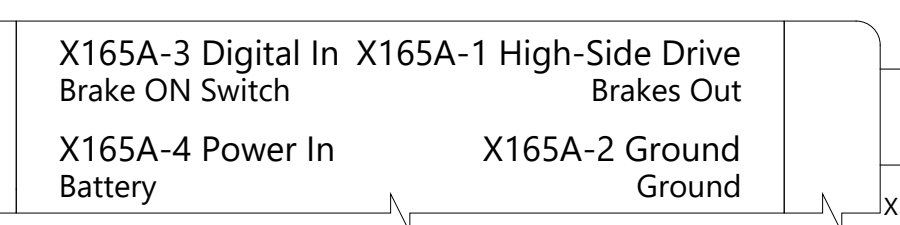

Trailer Light Controller
Trailer Jumper

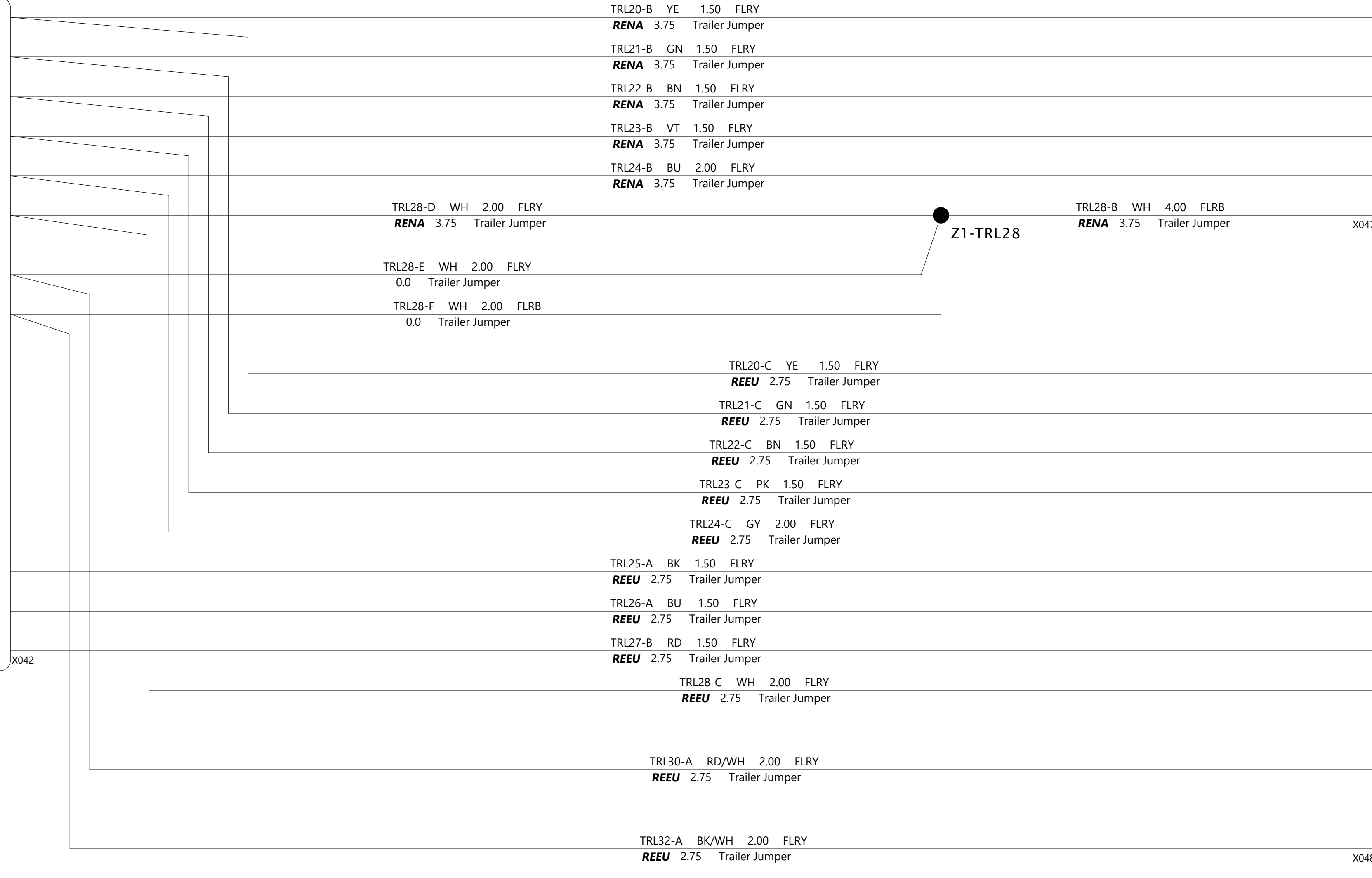
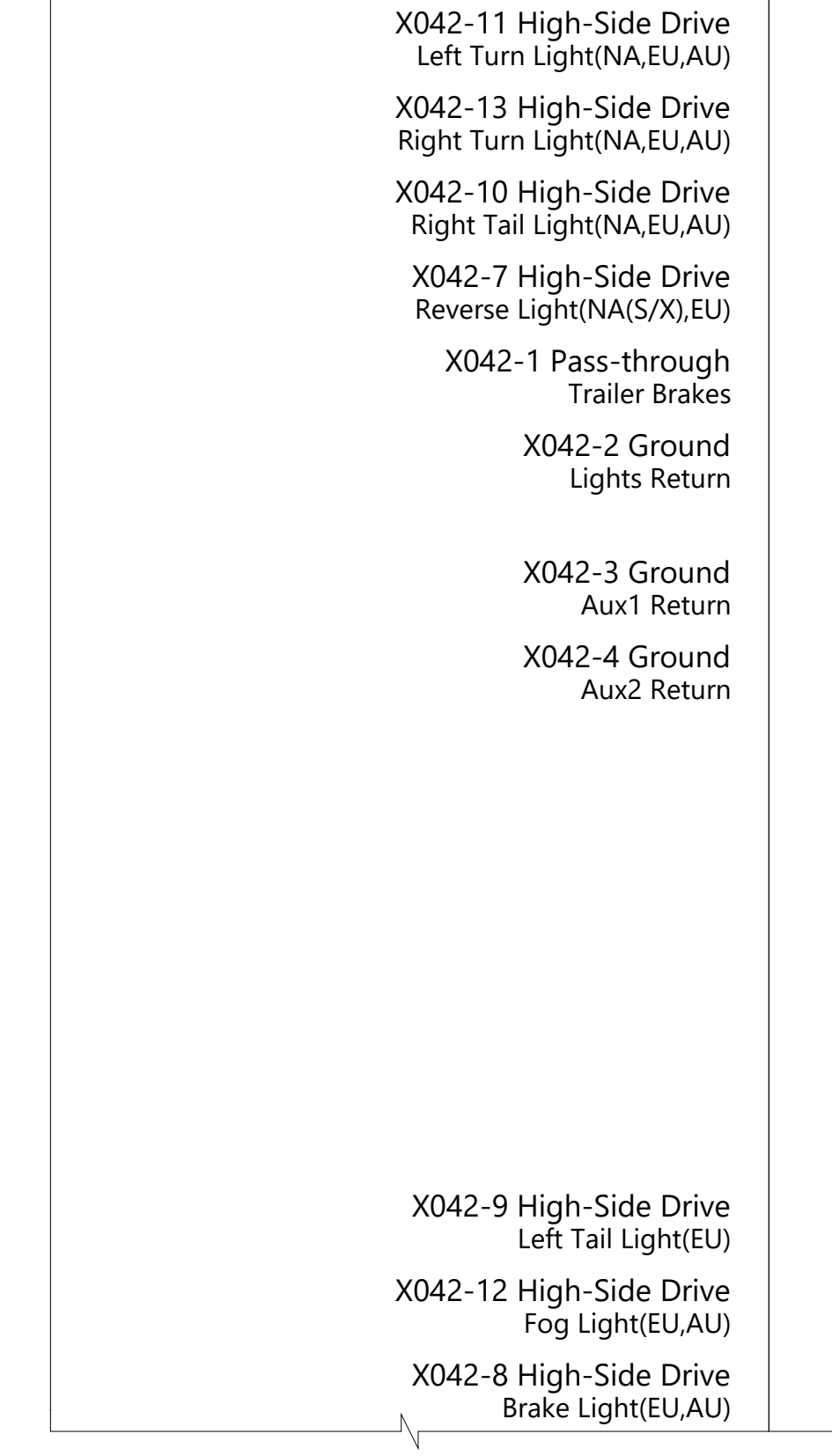

RENA
Trailer Socket, NA
Trailer Jumper

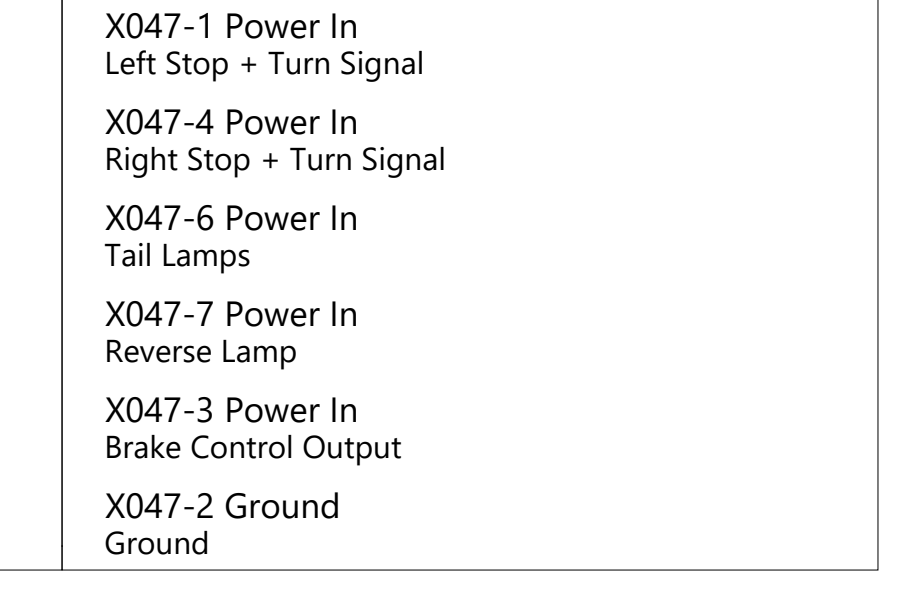

REEU
Trailer Socket, EU
Trailer Jumper

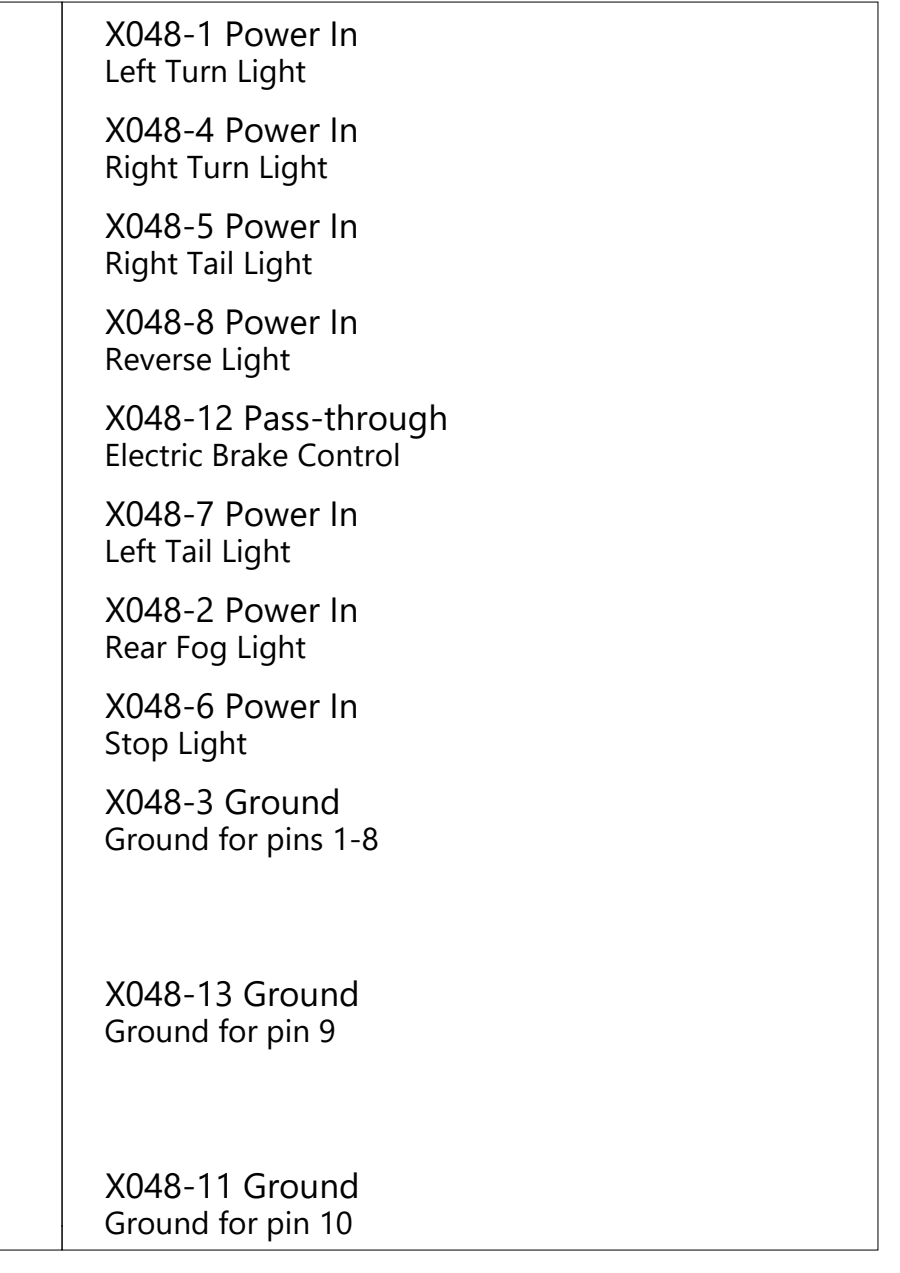

THE INFORMATION CONTAINED HEREIN IS DEEMED TO BE CONFIDENTIAL, PROPRIETARY, AND A TRADE SECRET OF TESLA MOTORS. THIS INFORMATION MAY NOT BE USED, REPRODUCED, OR DISCLOSED AS THE DIRECT OR INDIRECT BASIS FOR THE DEVELOPMENT, MANUFACTURE, OR SALE OF PROCESSES OR PRODUCTS WITHOUT THE EXPRESSED WRITTEN CONSENT OF TESLA MOTORS.

DRAWN	CHECKED	APPROVED
MATERIAL AS SPECIFIED	FINISHING AS SPECIFIED	SCALE NONE
PART NAME Towing		
PART NUMBER	REV	SHEET
	1	54 OF 55
		SCALE A0

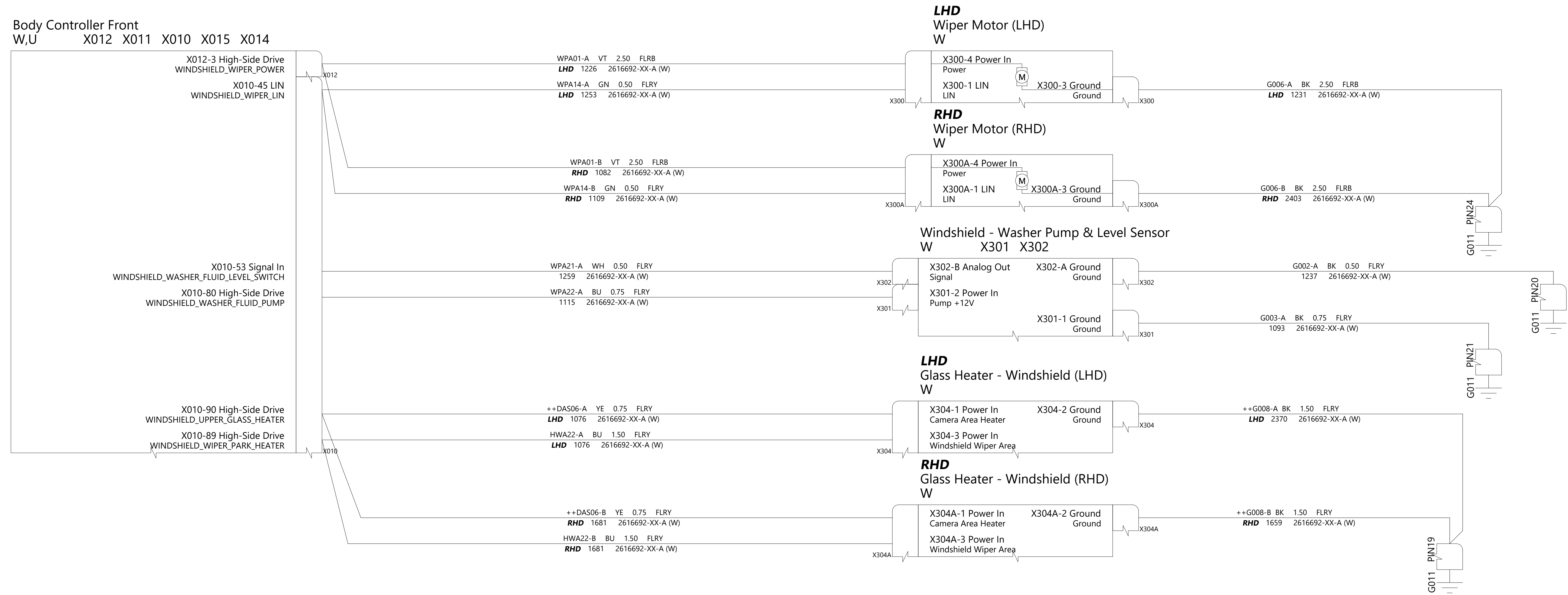

TESLA

THE INFORMATION CONTAINED HEREIN IS DEEMED TO BE CONFIDENTIAL, PROPRIETARY, AND A TRADE SECRET OF TESLA MOTORS. THIS INFORMATION MAY NOT BE USED, REPRODUCED, OR DISCLOSED AS THE DIRECT OR INDIRECT BASIS FOR THE DEVELOPMENT, MANUFACTURE, OR SALE OF PROCESSES OR PRODUCTS WITHOUT THE EXPRESSED WRITTEN CONSENT OF TESLA MOTORS.

DRAWN	CHECKED	APPROVED

MATERIAL AS SPECIFIED	FINISHING AS SPECIFIED	SCALE NONE
--------------------------	---------------------------	---------------

PART NAME
Windshield Wiper/Washer/Heater

PART NUMBER	REV	SHEET	SIZE
	1	55 of 55	A0