

Page	Description
1	Table of Contents
2	Controller Layout
3	Audio
4	Audio, Premium Amp
5	Audio, RHD
6	Body Controller Front High Current
7	Brake Controls
8	CAN Chassis
9	CAN Party
10	CAN Vehicle
11	Center Console
12	Charge Port Inlet
13	Diagnostics
14	Door Front Left
15	Door Front Right
16	Door Rear
17	Drive Inverters
18	Driver Assistance
19	Driver Assistance, RHD
20	Frunk Actuators/Sensors
21	Headliner
22	HV Battery & HVIL
23	HV Penthouse
24	HVAC - Powertrain
25	HVAC Case
26	HVAC Heat Pump
27	Instrument Panel
28	Liftgate and Trunk
29	Lighting - Exterior
30	Power Distribution, E-Fuse VCFront 1/2
31	Power Distribution, E-Fuse VCFront 2/2
32	Power Distribution, E-Fuse VCLeft 1/2
33	Power Distribution, E-Fuse VCLeft 2/2
34	Power Distribution, E-Fuse VCRight 1/2
35	Power Distribution, E-Fuse VCRight 2/2
36	Power Distribution, Grounding Cabin
37	Power Distribution, Grounding Frunk
38	Power Distribution, Grounding Liftgate
39	Restraint Controller - Airbags
40	Restraint Controller - Retractors
41	Restraint Controller - Sensors
42	RF/Special Cables
43	RF/Special Cables, RHD
44	Seats Front Left
45	Seats Front Right
46	Seats Second Row 40%
47	Seats Second Row 60%
48	Seats Second Row Cushion 5-Seater
49	Seats Second Row Cushion 7-Seater
50	Seats Third Row
51	Security Controls
52	Steering
53	Towing
54	Ultrasonics

LHST	Left side Seat
RHST	Right Side Seat
FOG	Fog Light
PCOLM	Power Steering Column
PAUDIO	Premium Audio
COLDW	Cold Weather Package
LHD	Left Hand Drive
RHD	Right Hand Drive
AWD	All Wheel Drive
RWD	Rear Wheel Drive
PINLT	Premium Interior Lights
PMIRR	Premium Mirror with Powerfold
REEU	Region Europe
RENA	Region North America
RECN	Region China
CSUSP	Coil Suspension
PREMST	Premium Seat
SBR	Seat Belt Reminder Switch
OCS	Occupant Classification System
STPS	Seat Track Position Sensor
CPGB	Chargeport GB
ARSC	Advance Radar Sensor
FSAB	Farside Airbag

Table 1: Abbreviations

LF	Left Front	RF	Right Front
LR	Left Rear	RR	Right Rear
LHS	Left-Hand Side	RHS	Right-Hand Side

Table 2: Harness Designators

A	LH BODY	R	LH RR DOOR
B	RH BODY	S	RH RR DOOR
C	CENTER CONSOLE	T	LIFT GATE
D	LH FR DOOR	TT	LIFT GATE TRIM
F	FR FASCIA	U	THERMAL
G	RR FASCIA	UHP	THERMAL, HEAT PUMP
H	HV PENTHOUSE	V	GLASS
J	IP	W	FRUNK
K	HEADLINER	X	REAR SUBFRAME
L	FRONT END MODULE	Y	FRONT SEATS
N	FRONT SUBFRAME	Z	MISC. CABLES
P	RH FR DOOR		

Table 3: Wire Color Designators

BK	Black	OG	Orange
BN	Brown	RD	Red
BU	Blue	VT	Violet (Purple)
GN	Green	WH	White
GY	Gray	YE	Yellow

Table 4: Wire Type Designators

FLRY	Thin wall 105C rated, regular stranded PVC insulated [FLRY-A]
FLRB	Thin wall 105C rated, bunched conductor PVC insulated [FLRY-B]
MCIIV	Thin wall 105C rated, compressed conductor PVC (halogen free) insulated
XR15	Thin wall 150C rated, cross-linked polyolefin, high flexible
FLXB	Thin wall 125C rated, cross-linked polyolefin, high flexible, halogen free insulated
3TBL	Thick wall 105C rated, aluminum conductor PVC insulated
F91X	Thin wall 150C rated, cross-linked polyethylene, high flexible

General Notes:

- Switches [Relays] are shown in their inactive [de-energized] state.
- Splices may be split across pages for visual clarity with respect to the function displayed on the particular page.
- Some connectors are split across multiple pages for clarity.
There is no overall reference in this document for the signals routed to a specific connector.
- Wire sizes are specified in mm² cross-sectional area (CSA) per SAE 1127/8
- Wire Specification: 60V, thin-wall PVC (ISO type or equivalent).
Default wire type to be rated 60VDC/25VAC and -40C to 105C operating temperature.
See DIN 13602 or ISO 6722 for detailed specifications.
- Unless otherwise specified at the device pins, terminal plating is to be Tin or Pre-Tin

TERMINAL PLATING

- GOLD TERMINAL NECESSARY
- SILVER PLATING NECESSARY

- Inline connector gender specification is based on the terminal type.
Inline connectors with "M" suffix have male, tab or pin terminals
Inline connectors with "F" suffix have female, receptacle or socket terminals

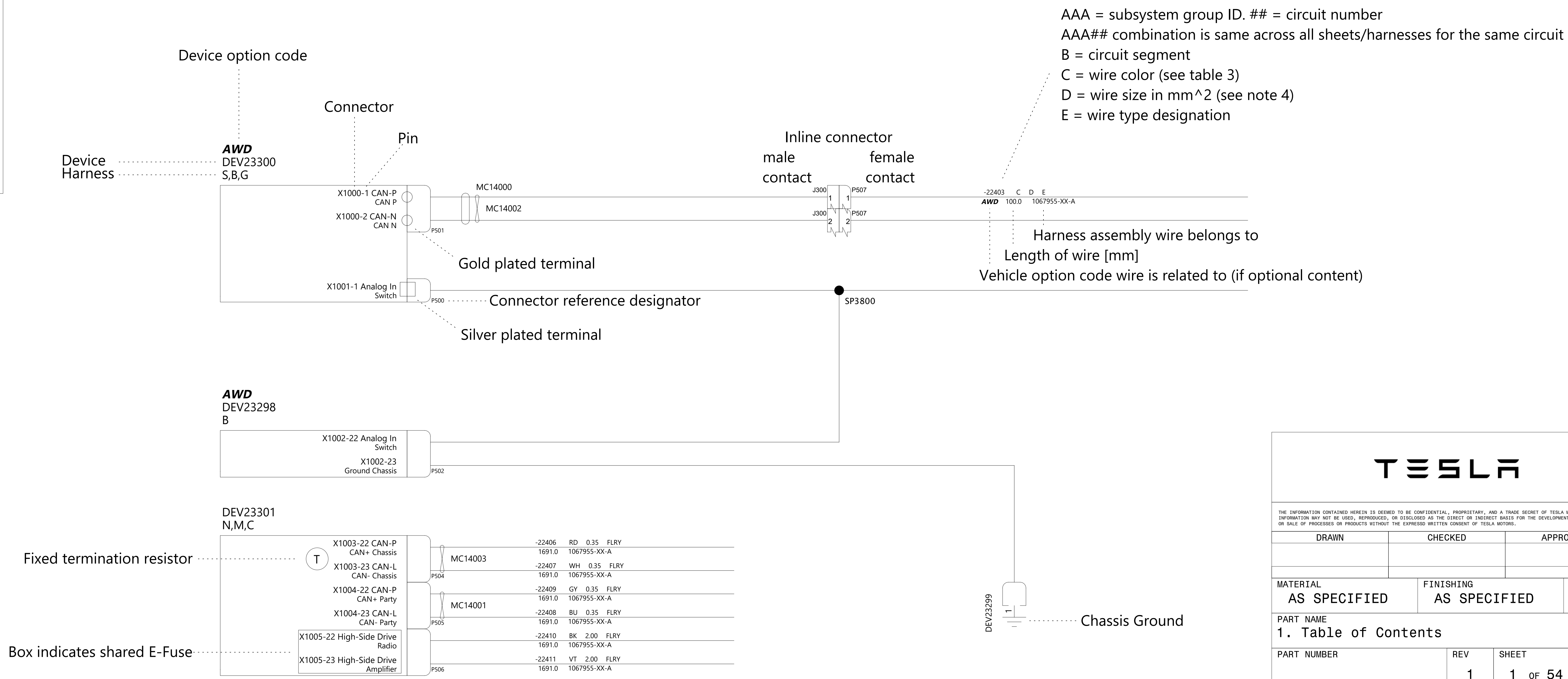

Left Controller

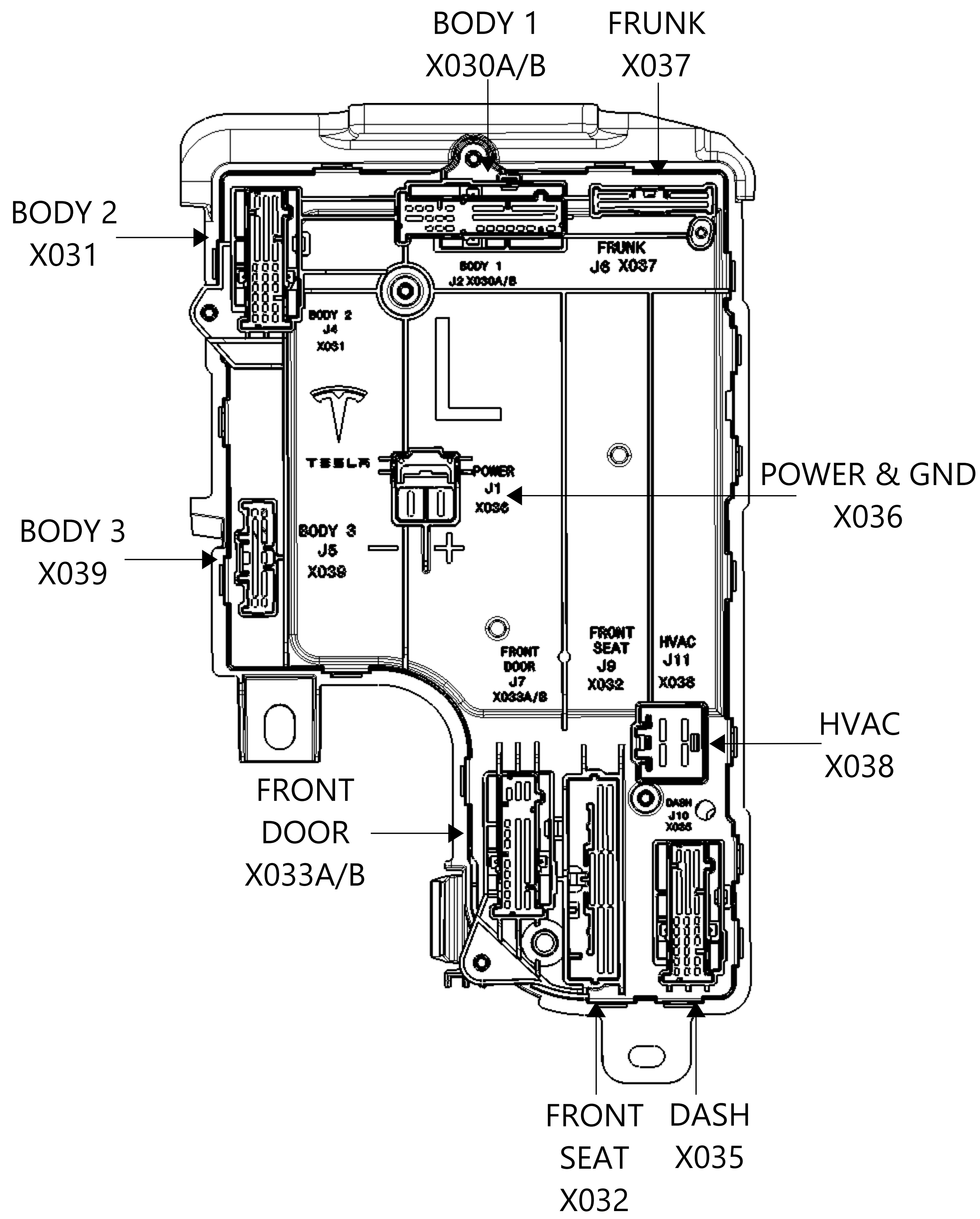

Front Controller

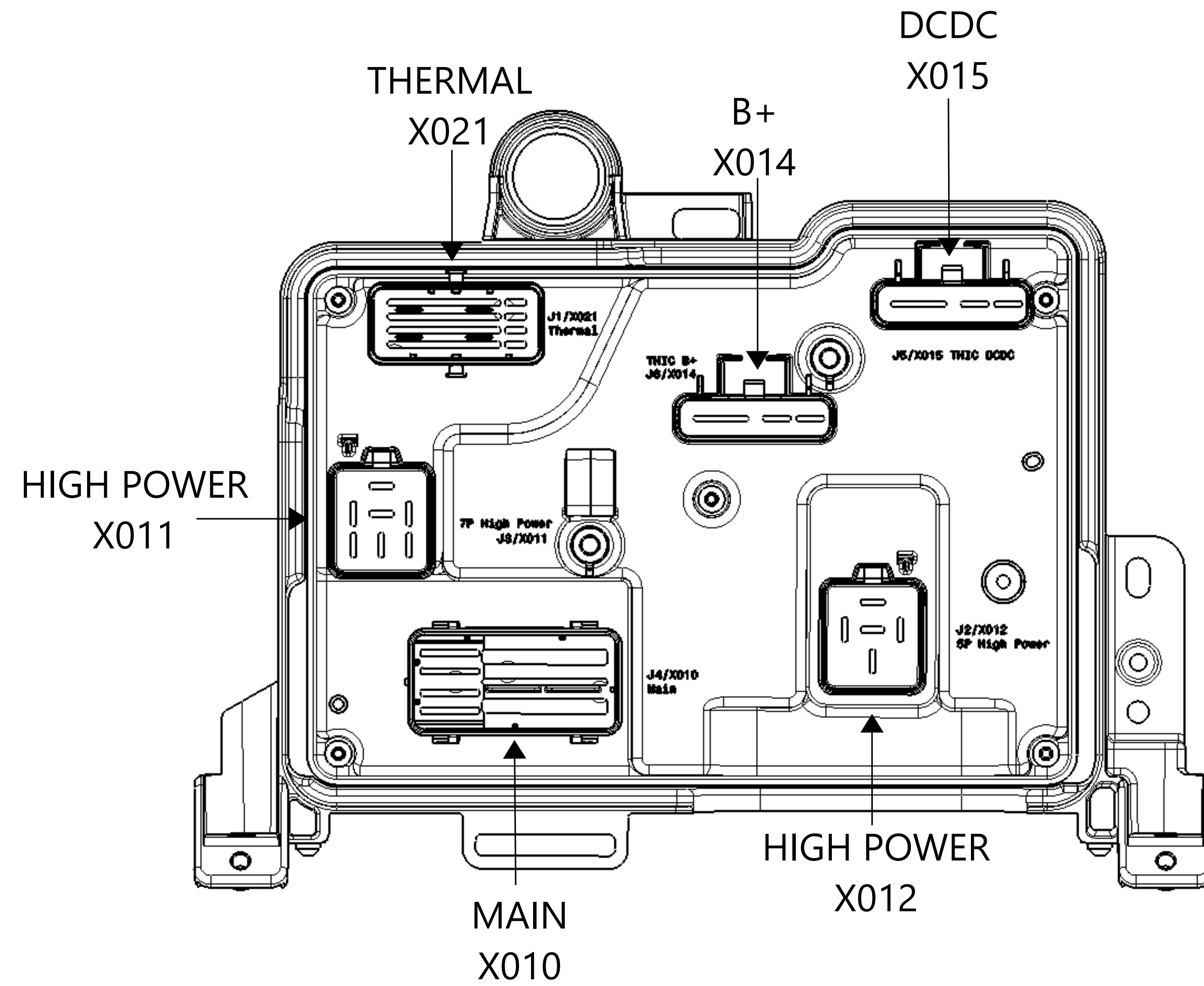

Right Controller

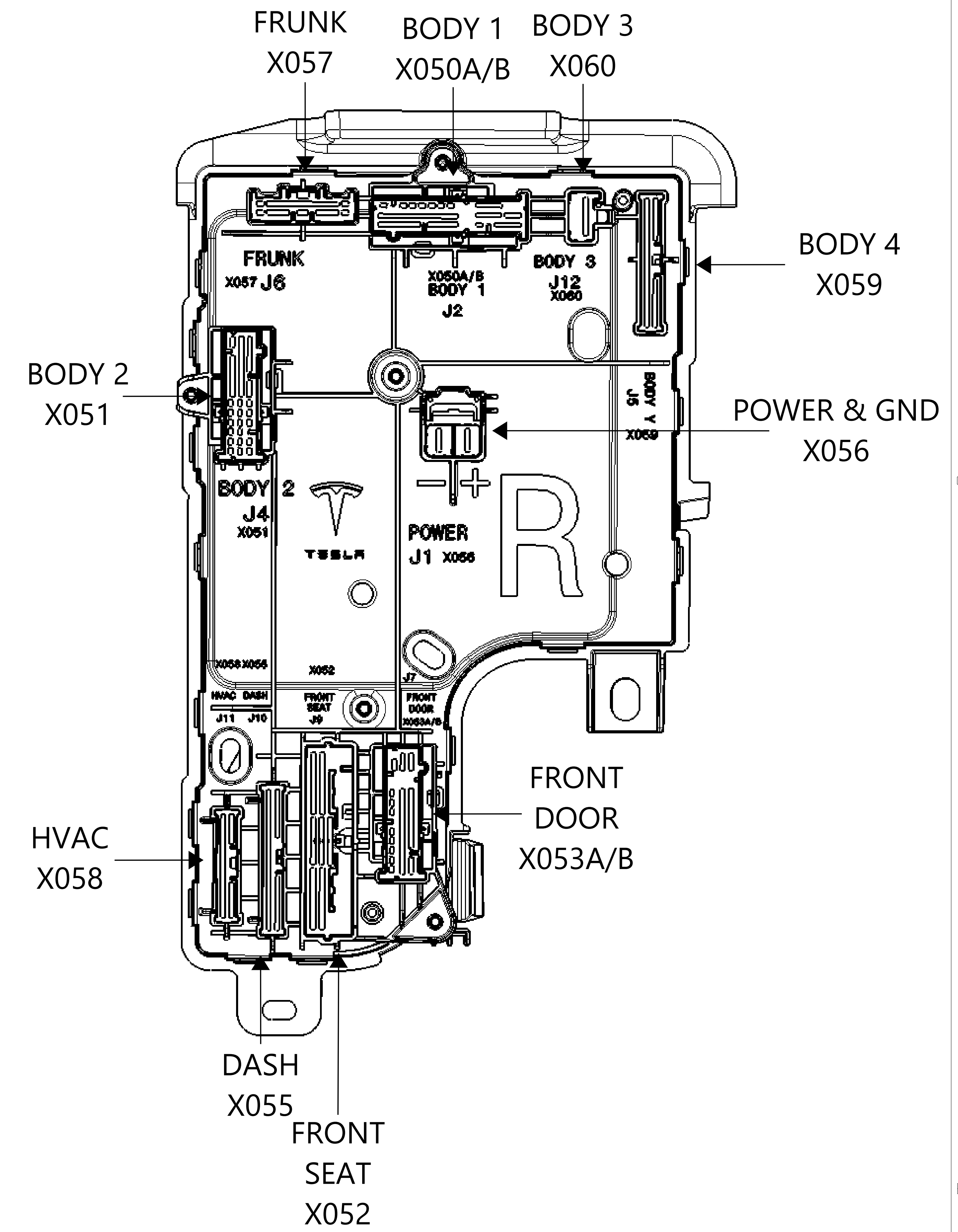

TESLA

THE INFORMATION CONTAINED HEREIN IS DEEMED TO BE CONFIDENTIAL, PROPRIETARY, AND A TRADE SECRET OF TESLA MOTORS. THIS INFORMATION MAY NOT BE USED, REPRODUCED, OR DISCLOSED AS THE DIRECT OR INDIRECT BASIS FOR THE DEVELOPMENT, MANUFACTURE, OR SALE OF PROCESSES OR PRODUCTS WITHOUT THE EXPRESS WRITTEN CONSENT OF TESLA MOTORS.

DRAWN	CHECKED	APPROVED
MATERIAL AS SPECIFIED	FINISHING AS SPECIFIED	SCALE NONE
PART NAME 2. Controller Layout		
PART NUMBER	REV	SHEET
	1	2 OF 54
		SIZE A0

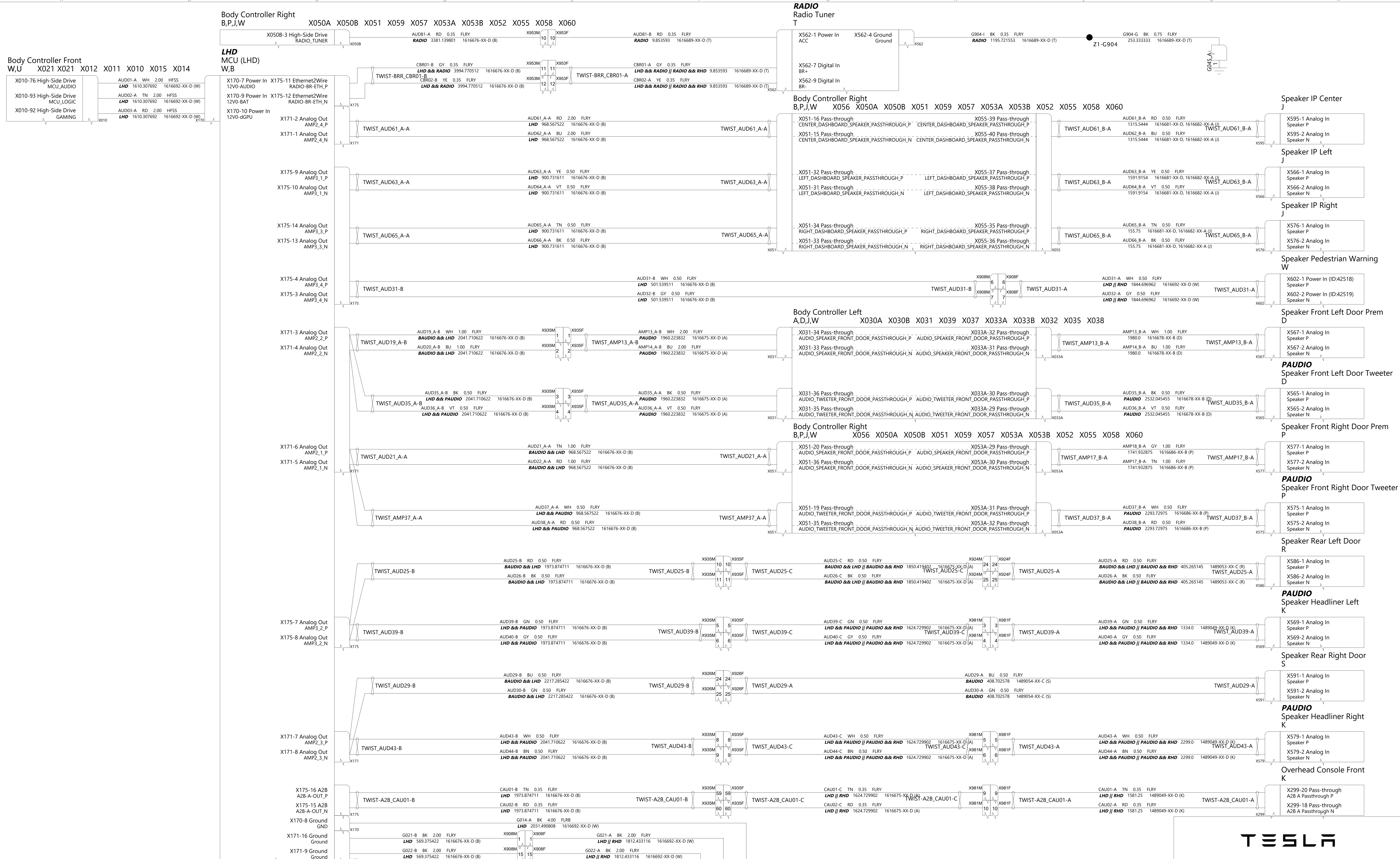

TESLA			
THE INFORMATION CONTAINED HEREIN IS DEEMED TO BE CONFIDENTIAL, PROPRIETARY, AND A TRADE SECRET OF TESLA MOTORS. THIS INFORMATION MAY NOT BE USED, REPRODUCED, OR DISCLOSED AS THE DIRECT OR INDIRECT BASIS FOR THE DEVELOPMENT, MANUFACTURE, OR SALE OF PROCESSES OR PRODUCTS WITHOUT THE EXPRESS WRITTEN CONSENT OF TESLA MOTORS.			
DRAWN	CHECKED	APPROVED	
MATERIAL AS SPECIFIED	FINISHING AS SPECIFIED	SCALE NONE	
PART NAME Audio			
PART NUMBER	REV	SHEET	SIZE
	1	3 OF 54	A0

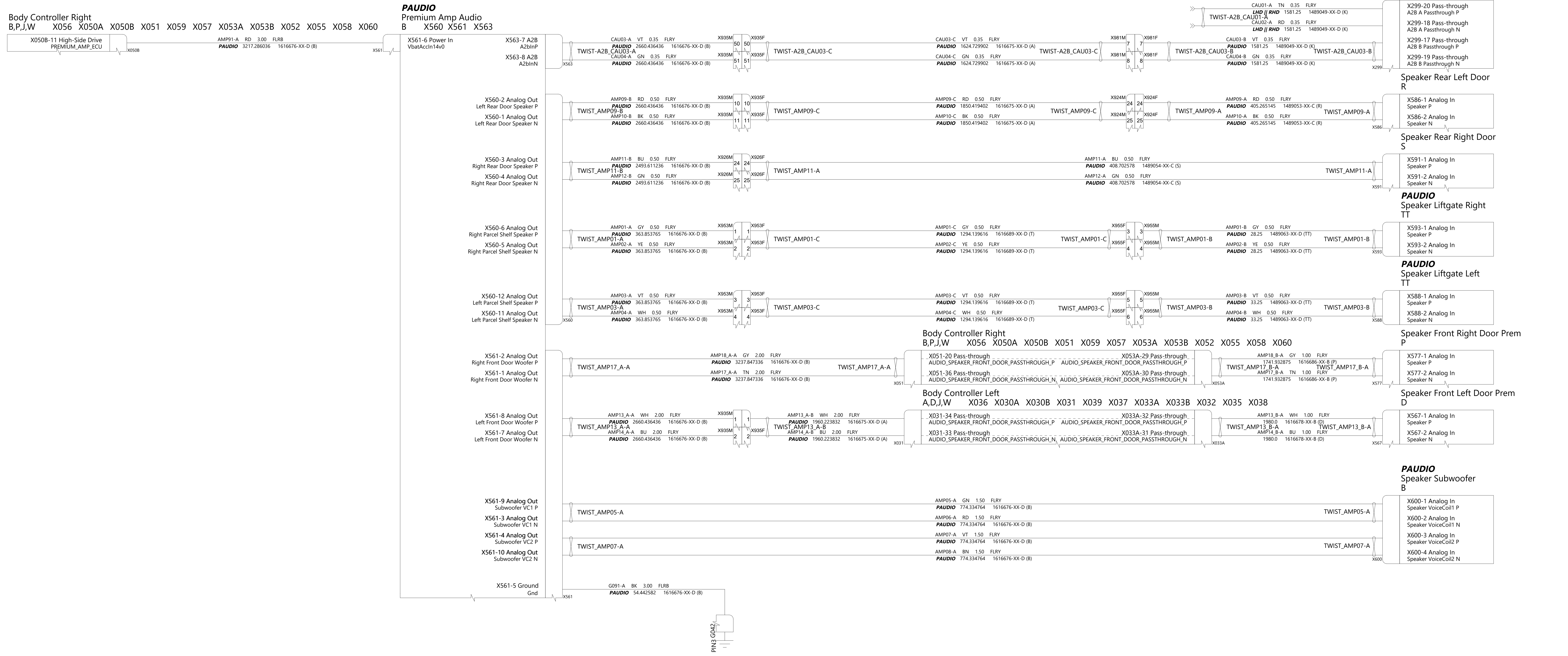

THE INFORMATION CONTAINED HEREIN IS DEEMED TO BE CONFIDENTIAL, PROPRIETARY, AND A TRADE SECRET OF TESLA MOTORS. THIS INFORMATION MAY NOT BE USED, REPRODUCED, OR DISCLOSED AS THE DIRECT OR INDIRECT BASIS FOR THE DEVELOPMENT, MANUFACTURE, OR SALE OF PROCESSES OR PRODUCTS WITHOUT THE EXPRESS WRITTEN CONSENT OF TESLA MOTORS.

DRAWN	CHECKED	APPROVED
MATERIAL AS SPECIFIED	FINISHING AS SPECIFIED	SCALE NONE
PART NAME Audio, Premium Amp		
PART NUMBER	REV	SHEET
	1	4 OF 54
		SIZE A0

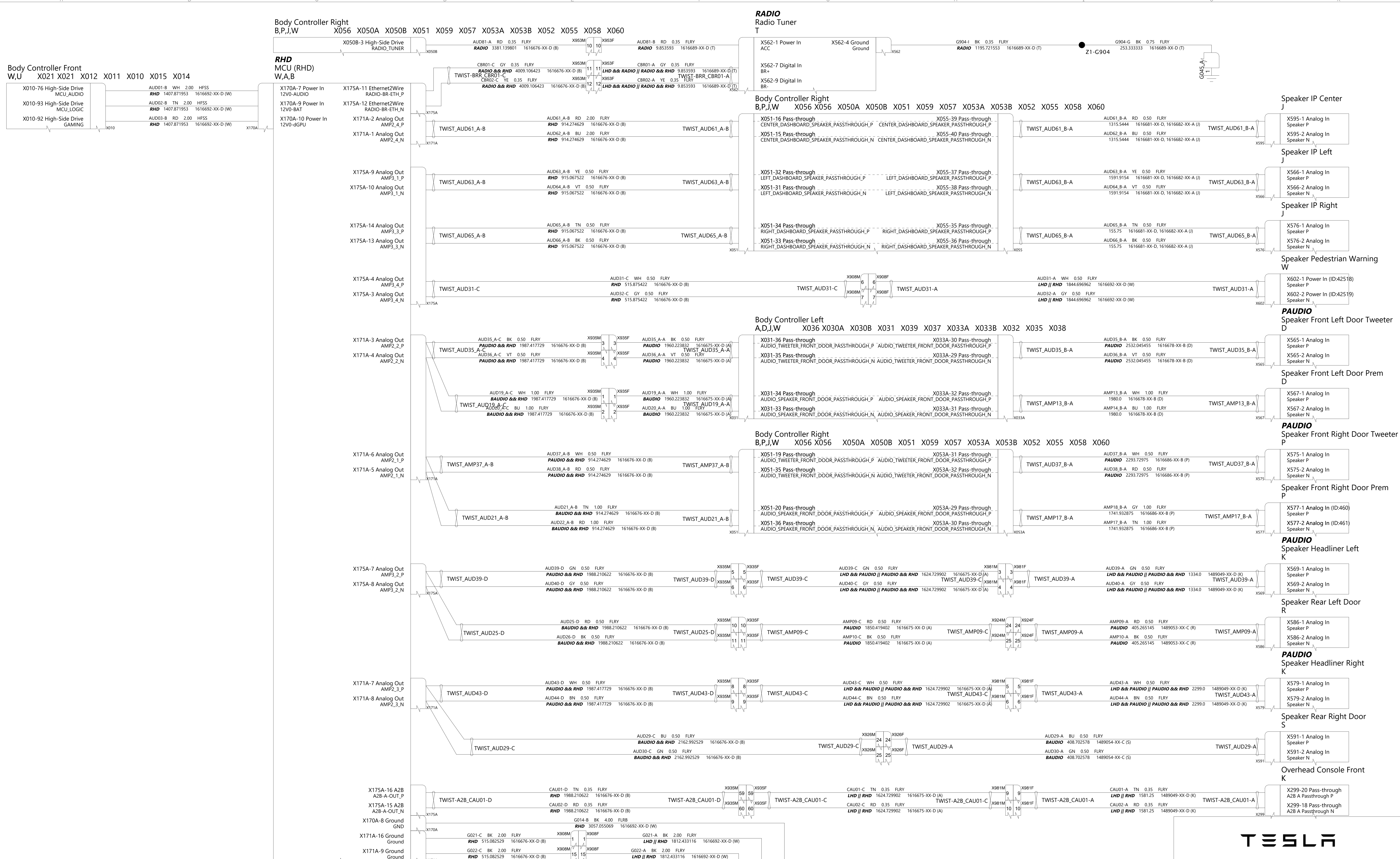

THE INFORMATION CONTAINED HEREIN IS DEEMED TO BE CONFIDENTIAL, PROPRIETARY, AND A TRADE SECRET OF TESLA MOTORS. THIS INFORMATION MAY NOT BE USED, REPRODUCED, OR DISCLOSED AS THE DIRECT OR INDIRECT BASIS FOR THE DEVELOPMENT, MANUFACTURE, OR SALE OF PROCESSES OR PRODUCTS WITHOUT THE EXPRESSED WRITTEN CONSENT OF TESLA MOTORS.

DRAWN	CHECKED	APPROVED
MATERIAL AS SPECIFIED	FINISHING AS SPECIFIED	SCALE NONE
PART NAME Audio, RHD		
PART NUMBER	REV	SHEET
	1	5 OF 54
		SIZE A0

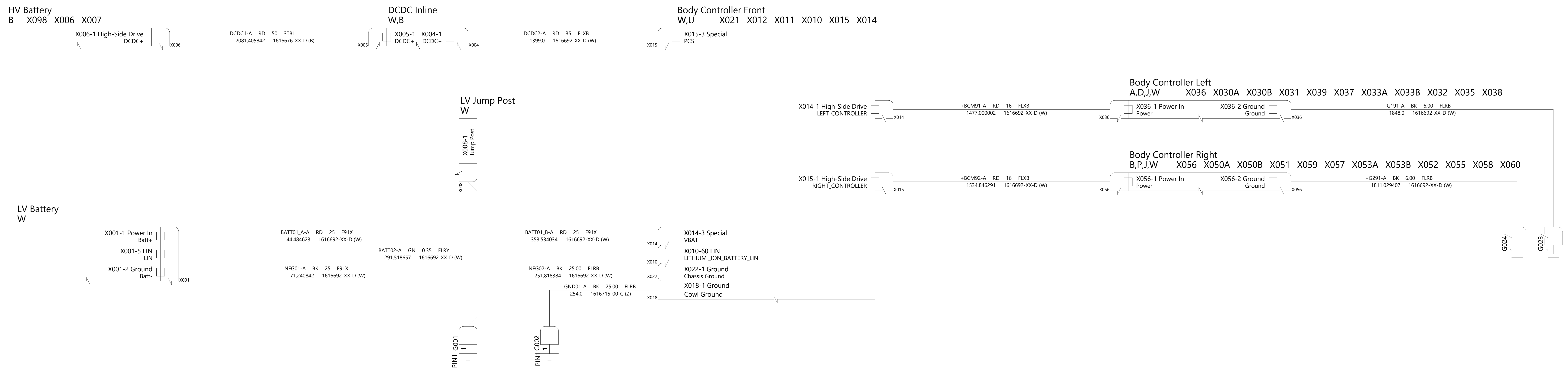

TESLA

THE INFORMATION CONTAINED HEREIN IS DEEMED TO BE CONFIDENTIAL, PROPRIETARY, AND A TRADE SECRET OF TESLA MOTORS. THIS INFORMATION MAY NOT BE USED, REPRODUCED, OR DISCLOSED AS THE OBJECT OR INDIRECT BASIS FOR THE DEVELOPMENT, MANUFACTURE, OR SALE OF PROCESSES OR PRODUCTS WITHOUT THE EXPRESSED WRITTEN CONSENT OF TESLA MOTORS.

DRAWN	CHECKED	APPROVED

MATERIAL AS SPECIFIED	FINISHING AS SPECIFIED	SCALE NONE
--------------------------	---------------------------	---------------

PART NAME
Body Controller Front High Current

PART NUMBER	REV	SHEET	SIZE
	1	6 OF 54	A0

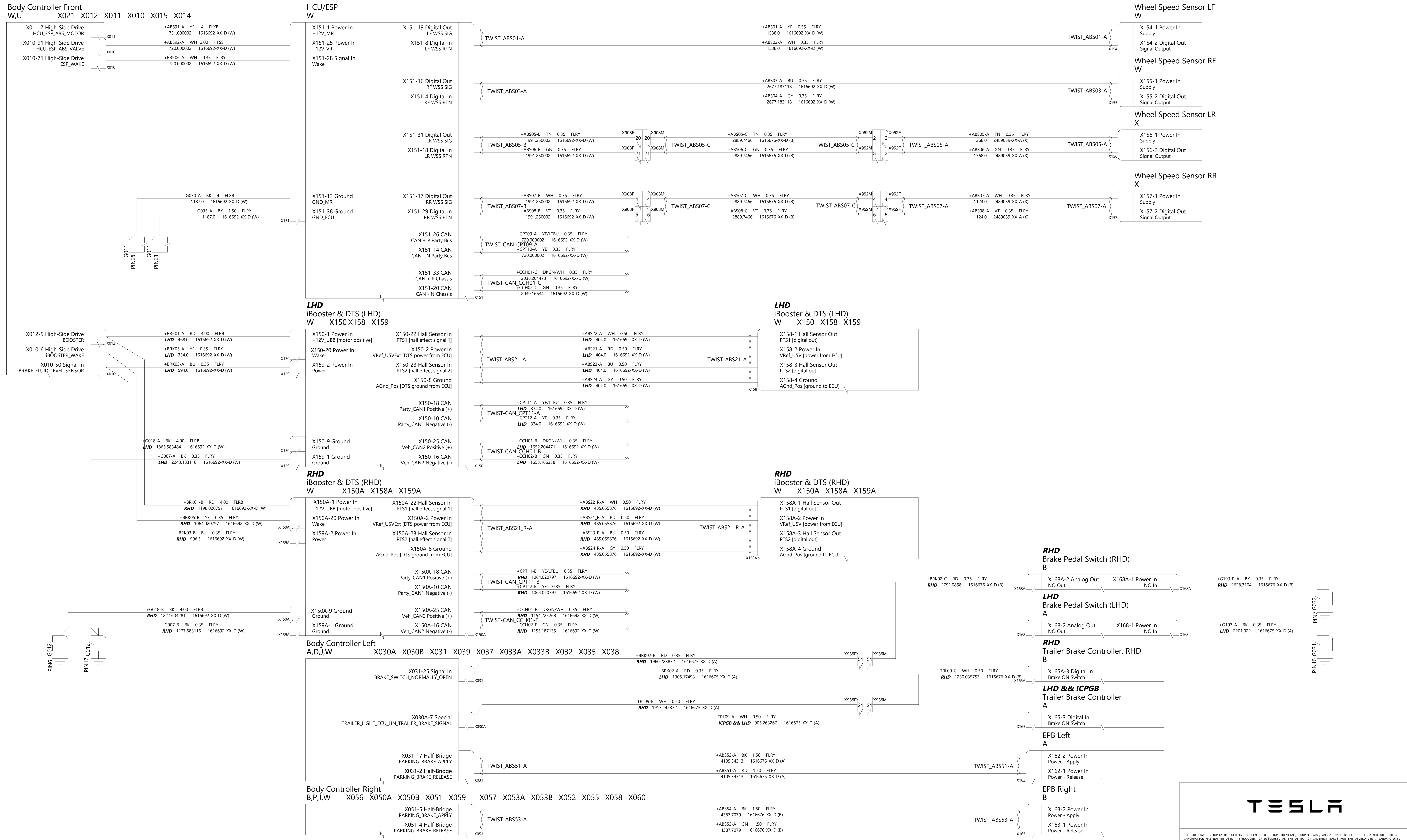

TESLA			
THE INFORMATION CONTAINED HEREIN IS DEEMED TO BE CONFIDENTIAL, PROPRIETARY, AND A TRADE SECRET OF TESLA MOTORS. THIS INFORMATION MAY NOT BE USED, REPRODUCED, OR DISCLOSED AS THE DIRECT OR INDIRECT BASIS FOR THE DEVELOPMENT, MANUFACTURE, OR SALE OF PROCESSES OR PRODUCTS WITHOUT THE EXPRESSED WRITTEN CONSENT OF TESLA MOTORS.			
DRAWN	CHECKED	APPROVED	
MATERIAL AS SPECIFIED	FINISHING AS SPECIFIED	SCALE NONE	
PART NAME Brake Controls			
PART NUMBER	REV	SHEET	SIZE
	1	7 OF 54	A0

LHD
Autopilot ECU (LHD)
W,J,B X120 X890 X838 X870 X891 X851 X801 X881 X830 X121

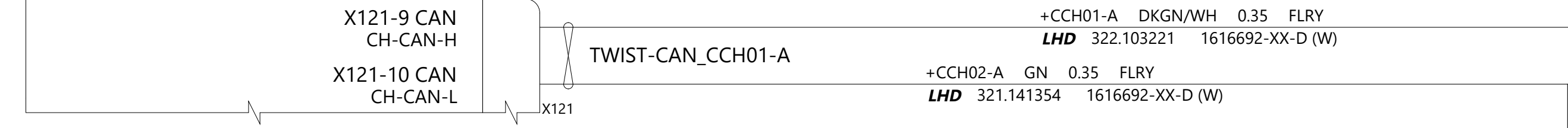

HCU/ESP
W

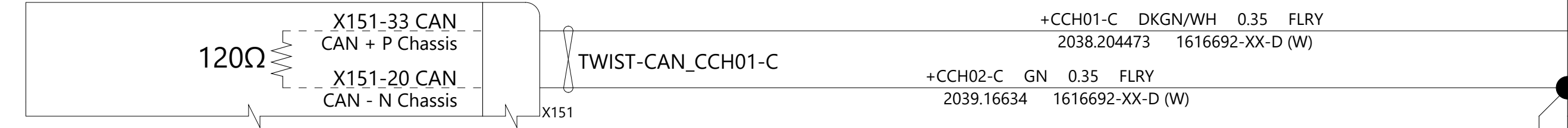

LHD
EPAS (LHD)
W

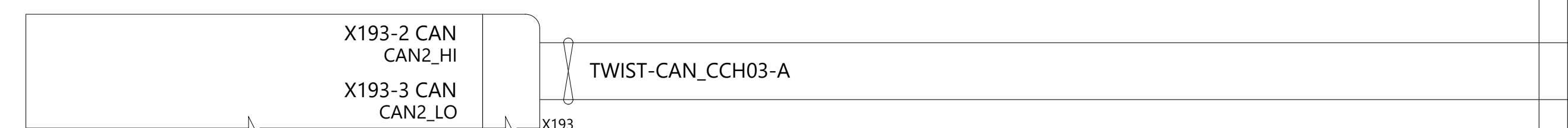

RHD
EPAS (RHD)
W

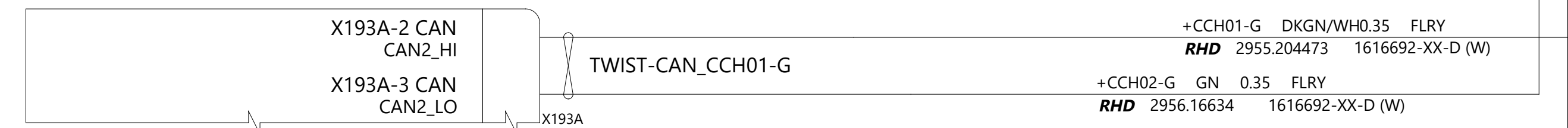

LHD
iBooster & DTS (LHD)
W X150 X158 X159

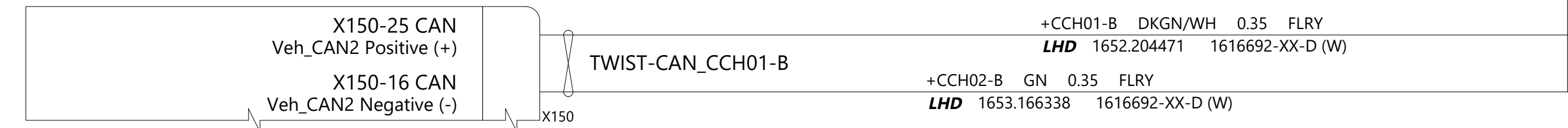

RHD
iBooster & DTS (RHD)
W X150A X158A X159A

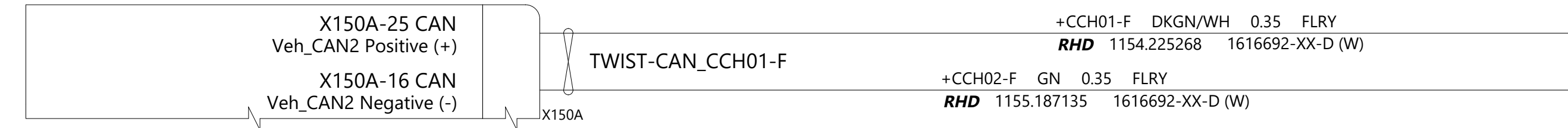

RHD
MCU (RHD)
W,A,B

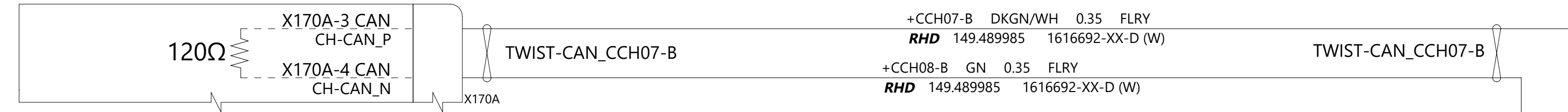

LHD
MCU (LHD)
W,B

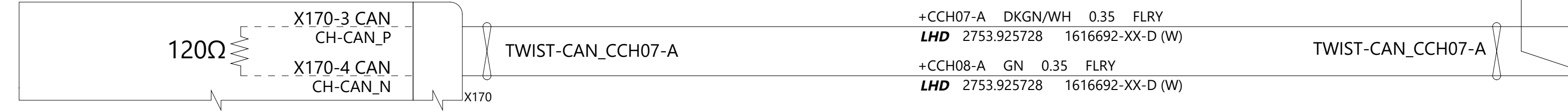

RHD
Autopilot ECU (RHD)
W,J,B

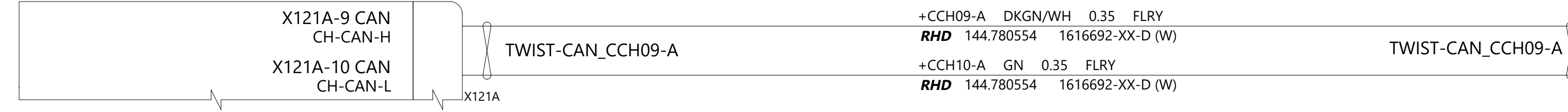

Restraints Controller
A,J X200 X201

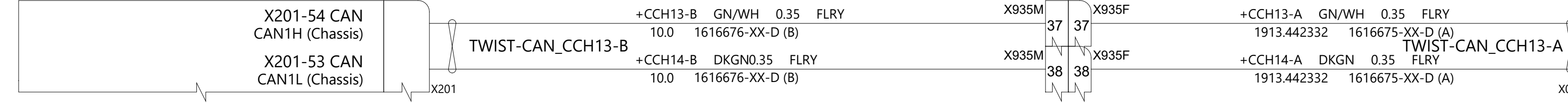

OCS
OCS
Y

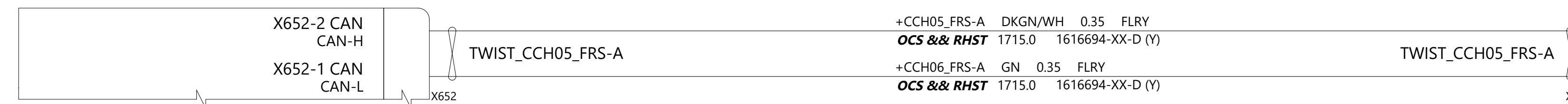

Body Controller Left
A,D,J,W X036 X030A X030B X031 X039 X037 X033A X033B X032 X035 X038

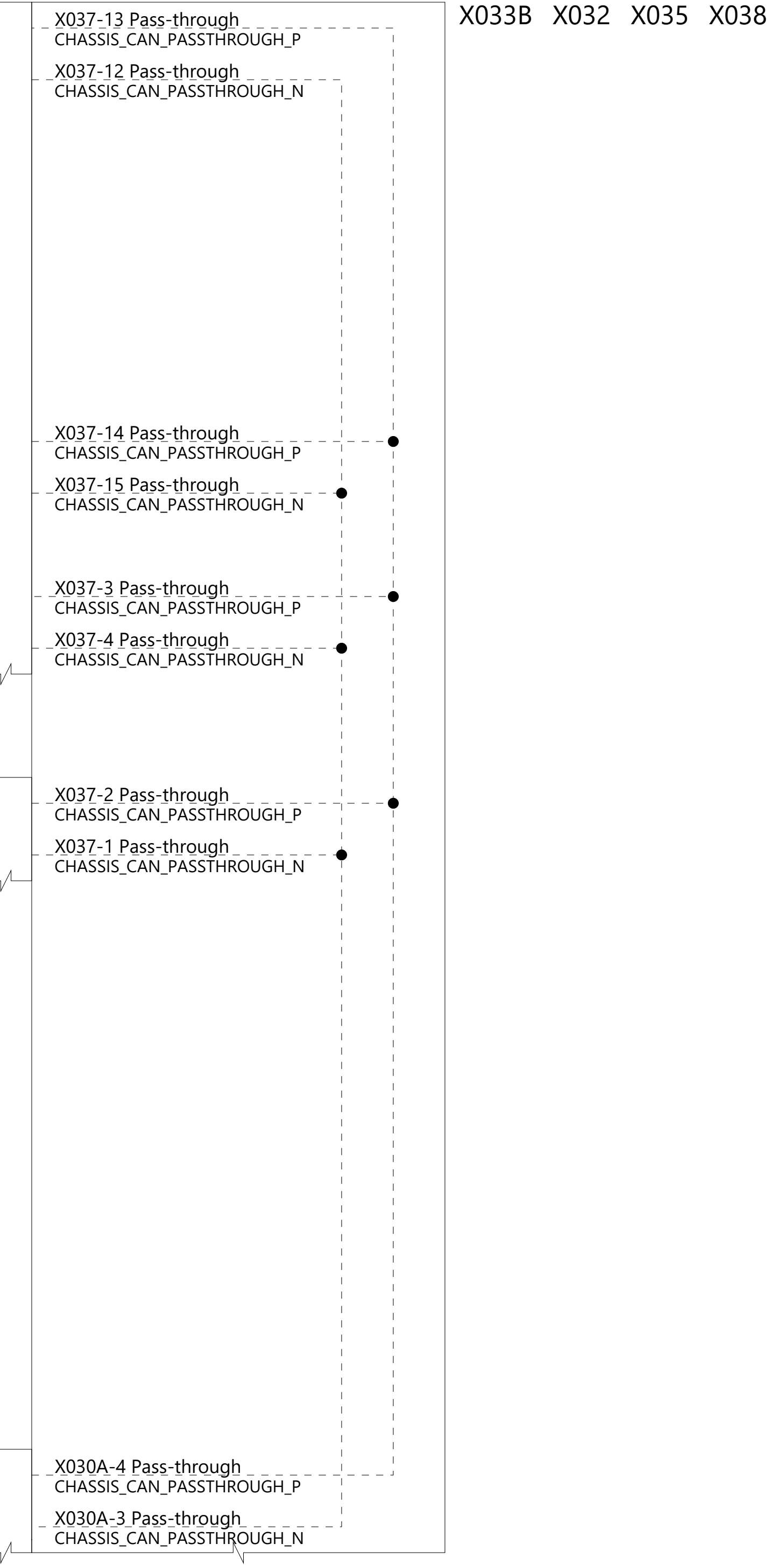

Body Controller Right
B,P,J,W X056 X050A X050B X051 X059 X057 X053A X053B X052 X055 X058 X060

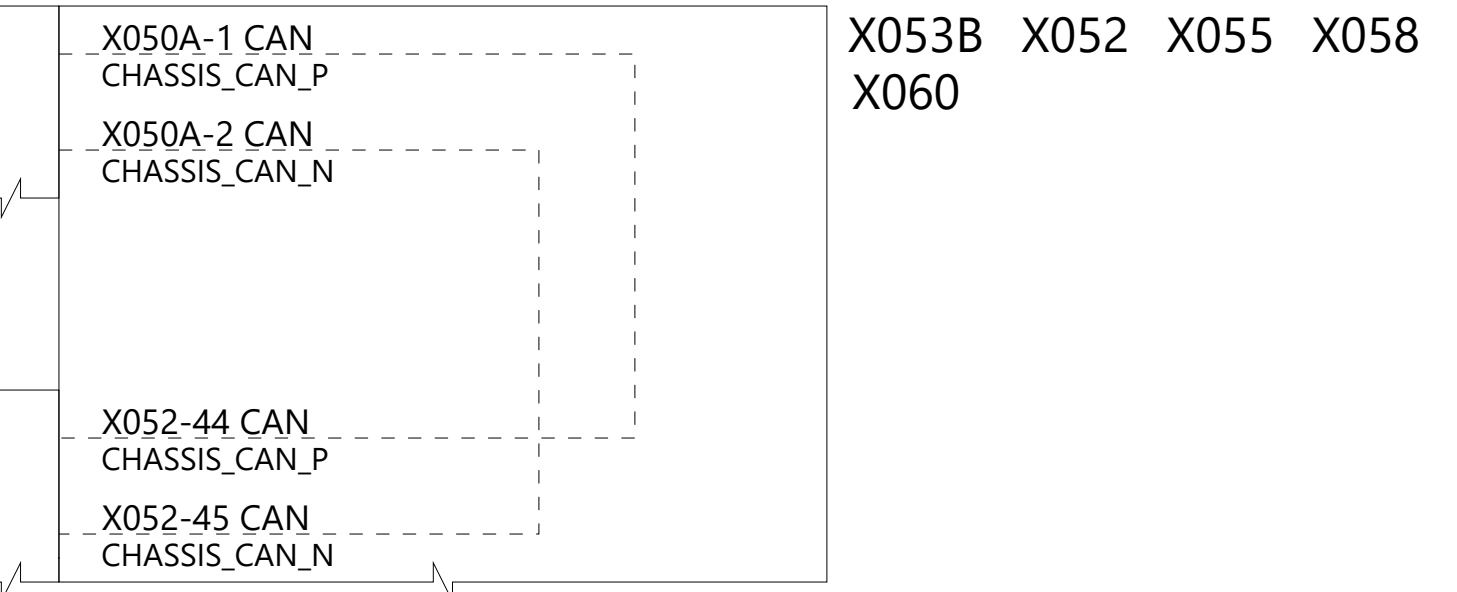

TESLA

THE INFORMATION CONTAINED HEREIN IS DEEMED TO BE CONFIDENTIAL, PROPRIETARY, AND A TRADE SECRET OF TESLA MOTORS. THIS INFORMATION MAY NOT BE USED, REPRODUCED, OR DISCLOSED AS THE DIRECT OR INDIRECT BASIS FOR THE DEVELOPMENT, MANUFACTURE, OR SALE OF PROCESSES OR PRODUCTS WITHOUT THE EXPRESSED WRITTEN CONSENT OF TESLA MOTORS.

DRAWN	CHECKED	APPROVED
MATERIAL AS SPECIFIED	FINISHING AS SPECIFIED	SCALE NONE
PART NAME CAN Chassis		
PART NUMBER	REV	SHEET
	1	8 OF 54
		A0

Body Controller Front
W,U X021 X021 X012 X011 X010

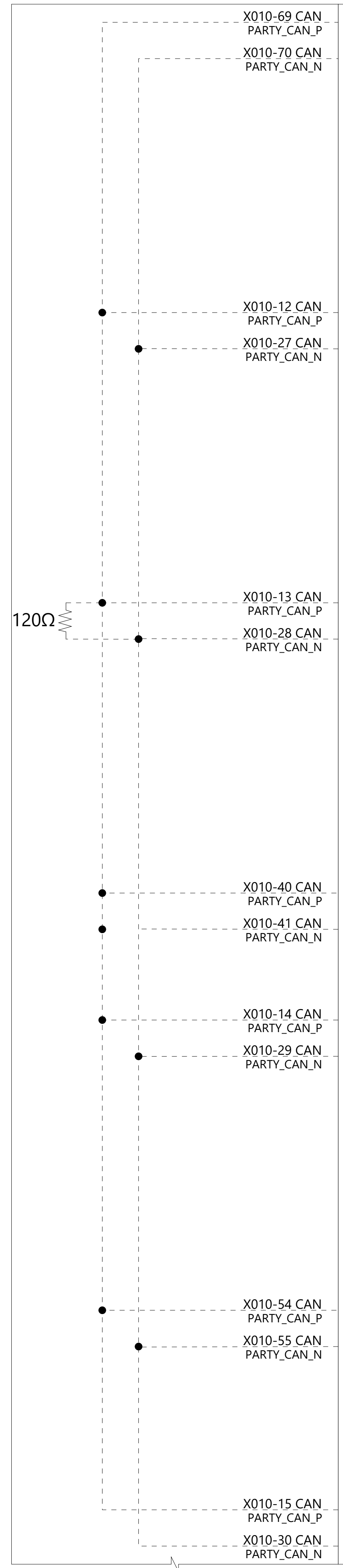

X015 X014

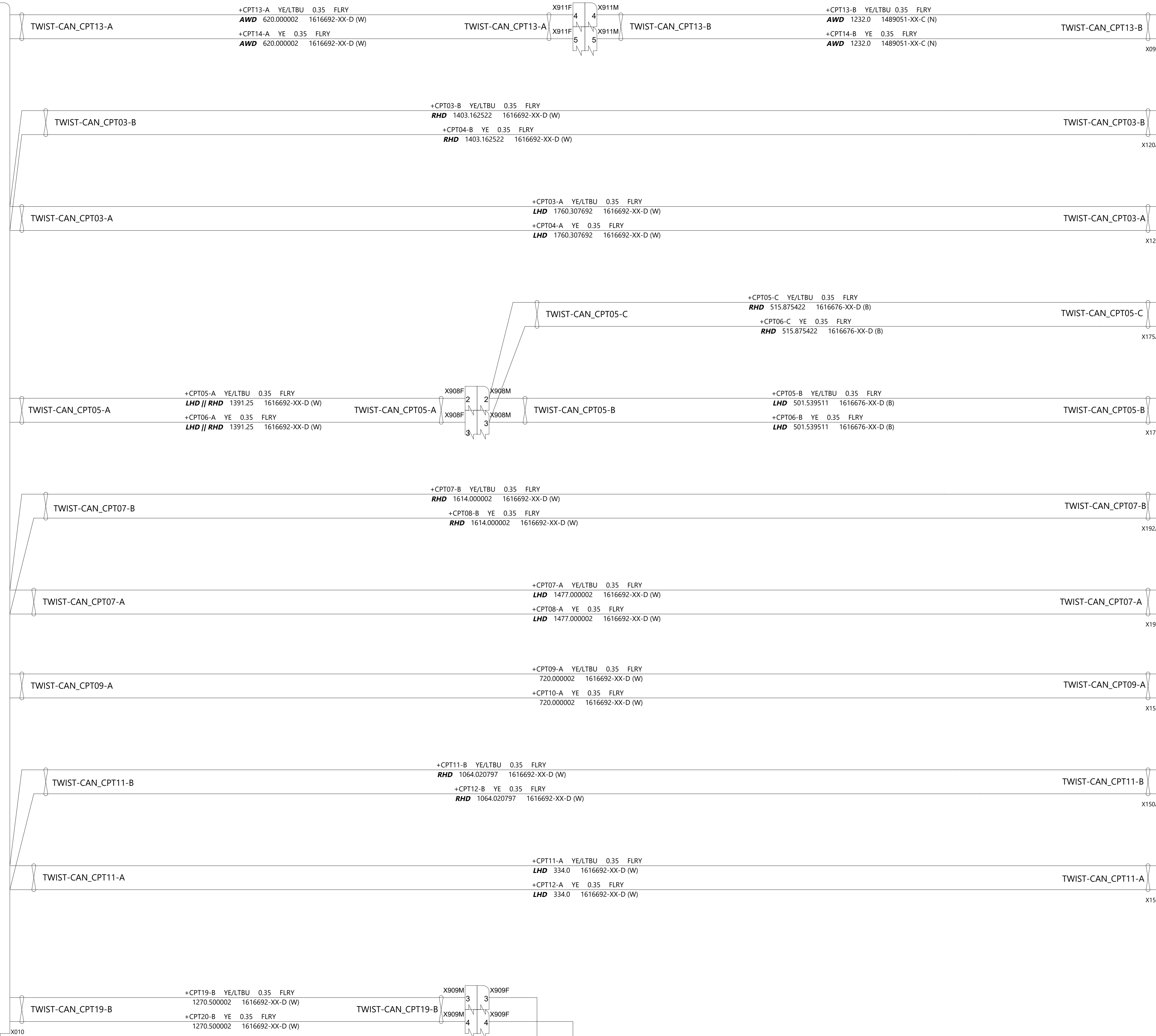

AWD Drive Inverter Front & Resolver
N X093 X094

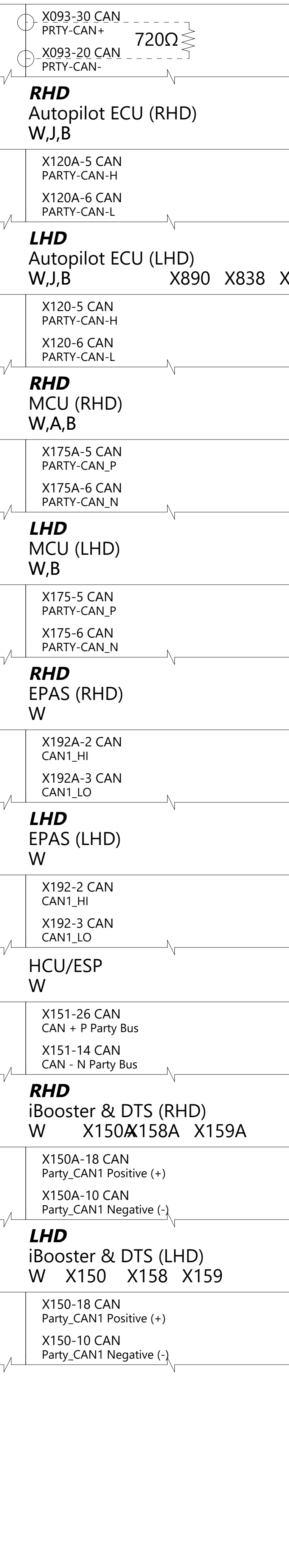

Body Controller Left
A,D,J,W X036 X030A X030B X031

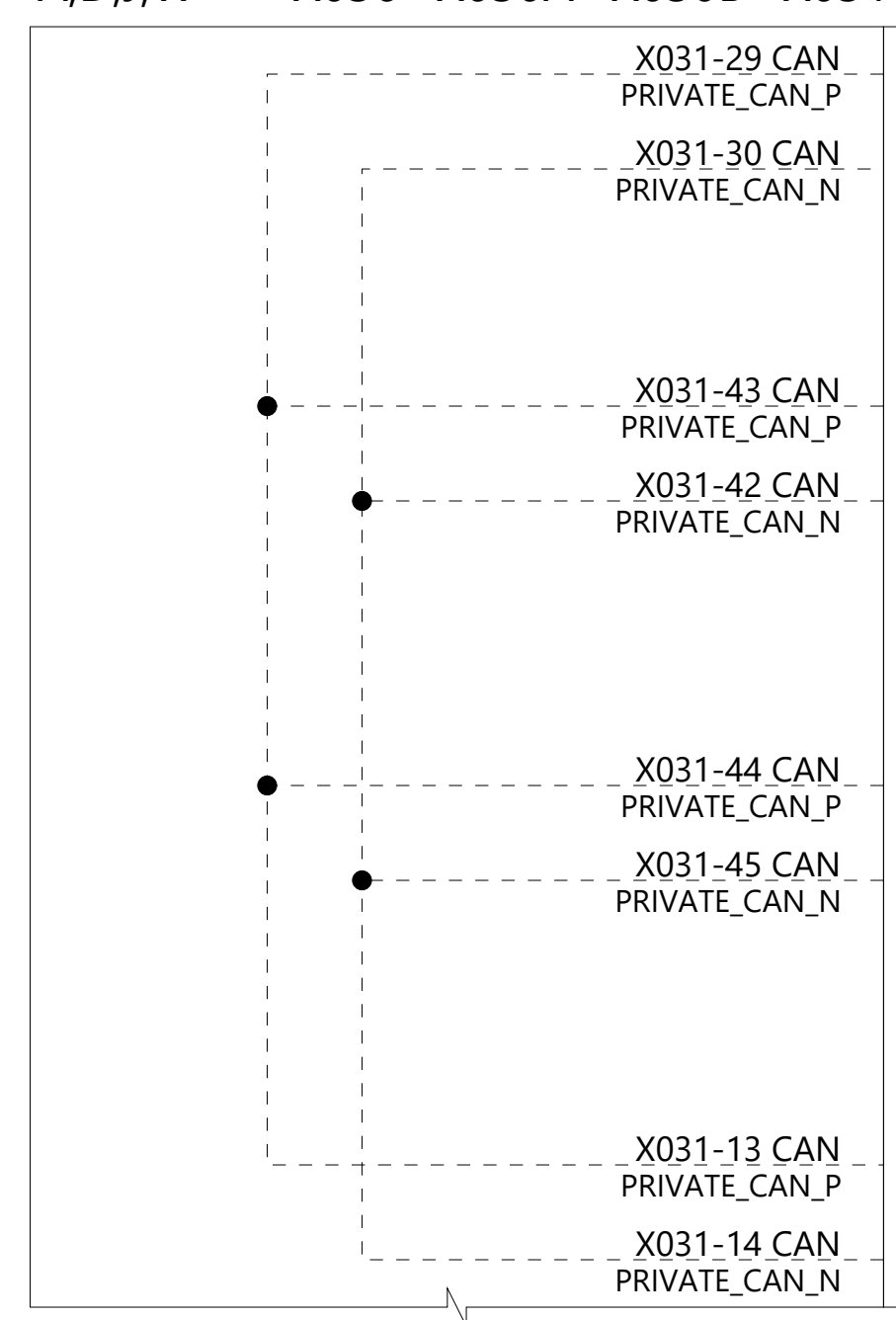

X039 X037 X033A X033B X032 X035 X038

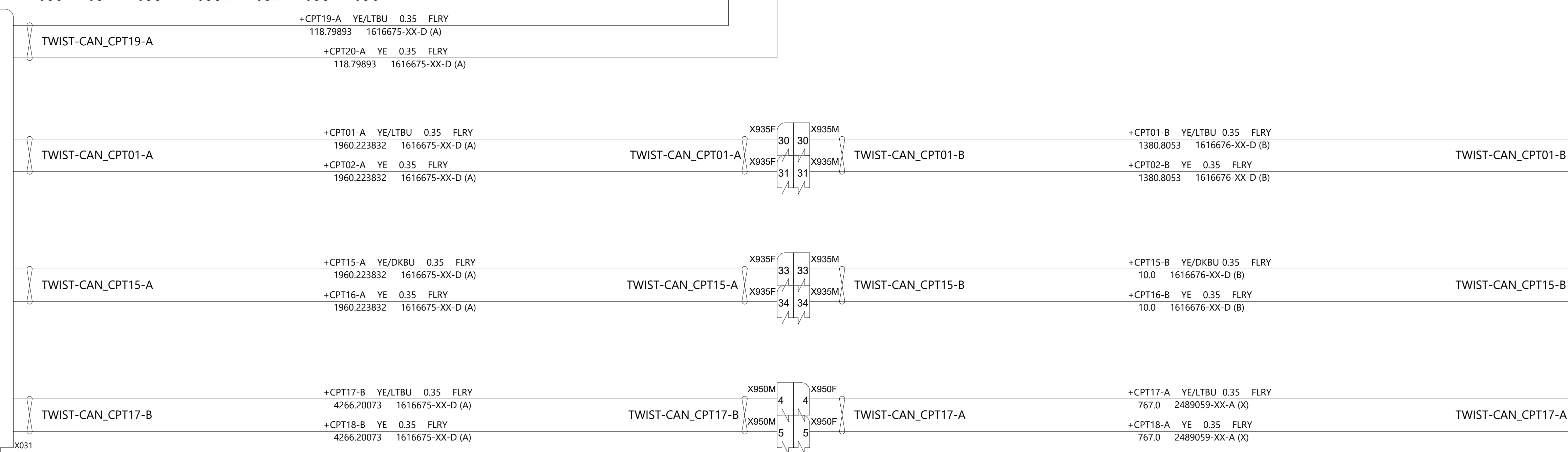

Body Controller Right
B,P,J,W X056 X056 X050A X050B X051 X059 X057 X053A X053B X052 X055 X058 X060

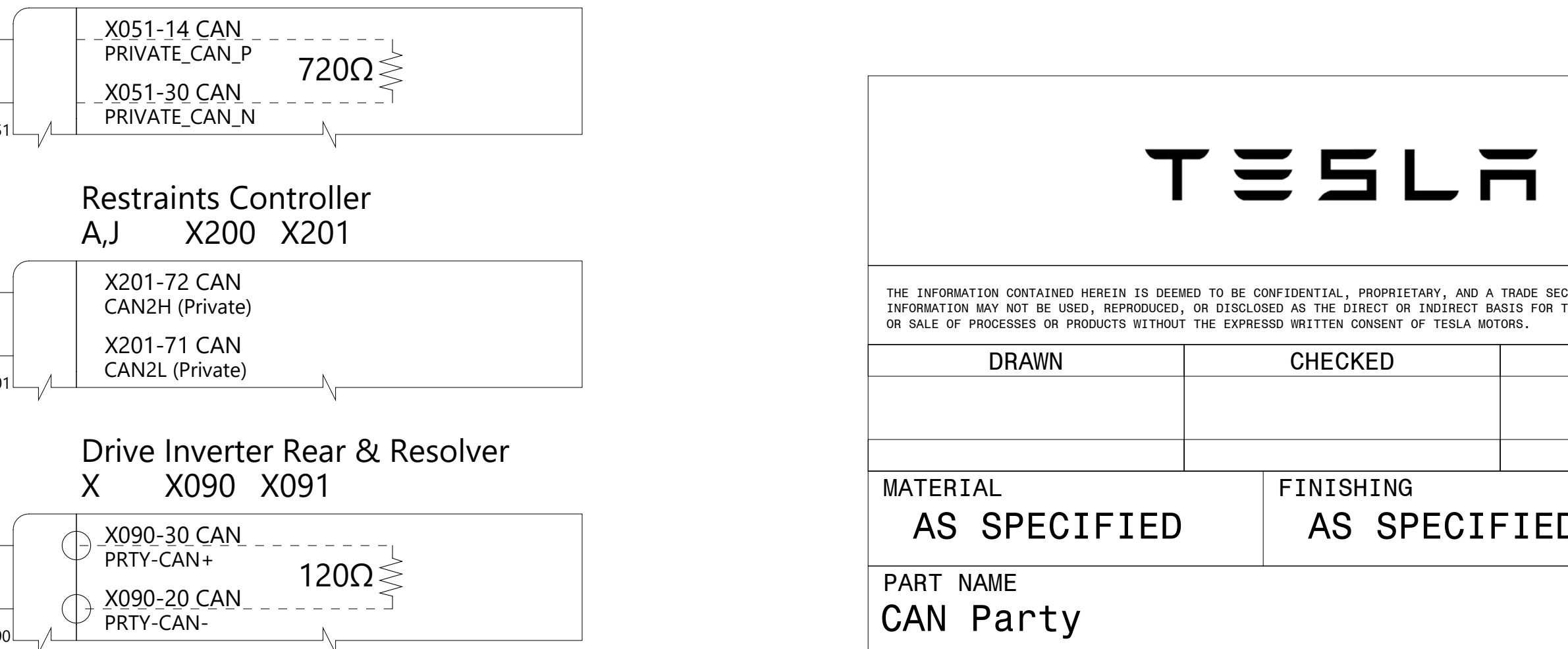

Restraints Controller
A,J X200 X201

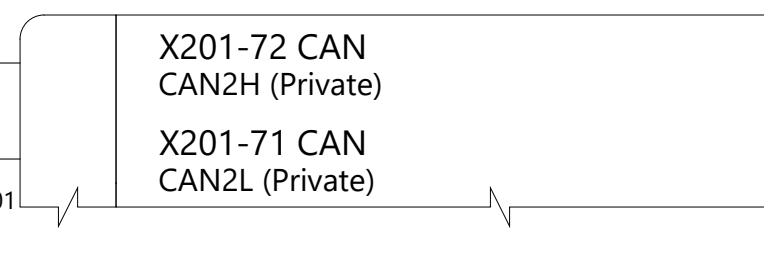

Drive Inverter Rear & Resolver
X X090 X091

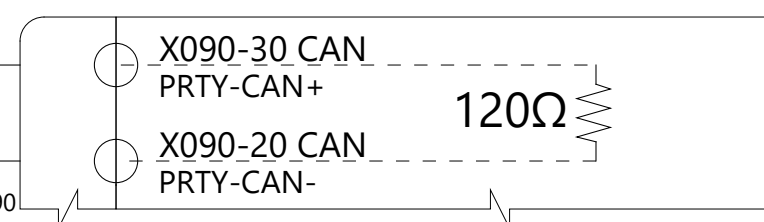

THE INFORMATION CONTAINED HEREIN IS DEEMED TO BE CONFIDENTIAL, PROPRIETARY, AND A TRADE SECRET OF TESLA MOTORS. THIS INFORMATION MAY NOT BE USED, REPRODUCED, OR DISCLOSED AS THE DIRECT OR INDIRECT BASIS FOR THE DEVELOPMENT, MANUFACTURE, OR SALE OF PROCESSES OR PRODUCTS WITHOUT THE EXPRESSED WRITTEN CONSENT OF TESLA MOTORS.

DRAWN	CHECKED	APPROVED
MATERIAL AS SPECIFIED	FINISHING AS SPECIFIED	SCALE NONE
PART NAME CAN Party		
PART NUMBER	REV 1	SHEET 9 OF 54
		SIZE A0

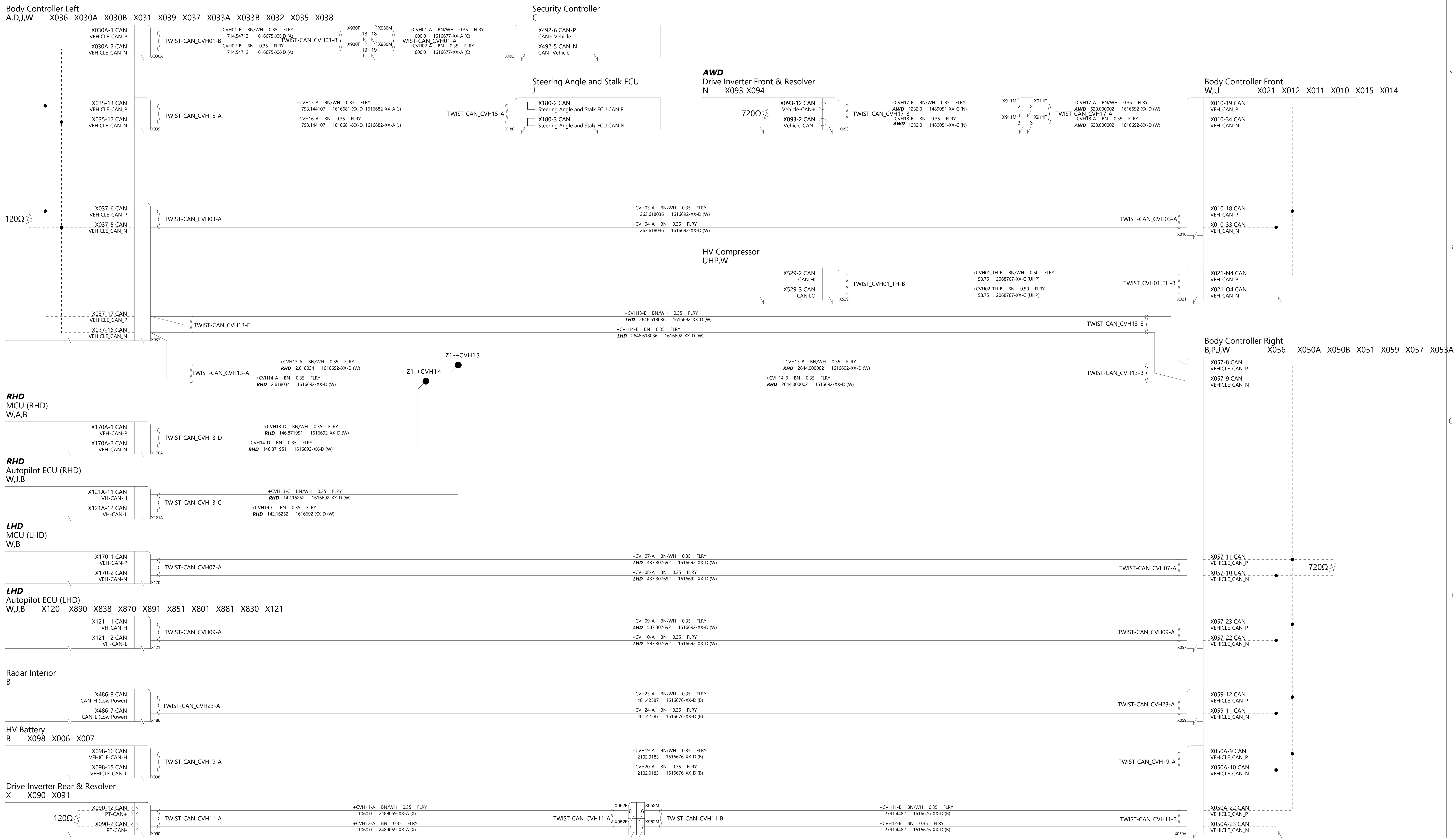

TESLA

THE INFORMATION CONTAINED HEREIN IS DEEMED TO BE CONFIDENTIAL, PROPRIETARY, AND A TRADE SECRET OF TESLA MOTORS. THIS INFORMATION MAY NOT BE USED, REPRODUCED, OR DISCLOSED AS THE DIRECT OR INDIRECT BASIS FOR THE DEVELOPMENT, MANUFACTURE, OR SALE OF PROCESSES OR PRODUCTS WITHOUT THE EXPRESSED WRITTEN CONSENT OF TESLA MOTORS.

DRAWN	CHECKED	APPROVED
-------	---------	----------

MATERIAL AS SPECIFIED	FINISHING AS SPECIFIED	SCALE NONE
--------------------------	---------------------------	---------------

PART NAME
CAN Vehicle

PART NUMBER	REV	SHEET	SIZE
	1	10 of 54	A0

Body Controller Left
A,D,J,W X036 X030A X030B X031 X039 X037

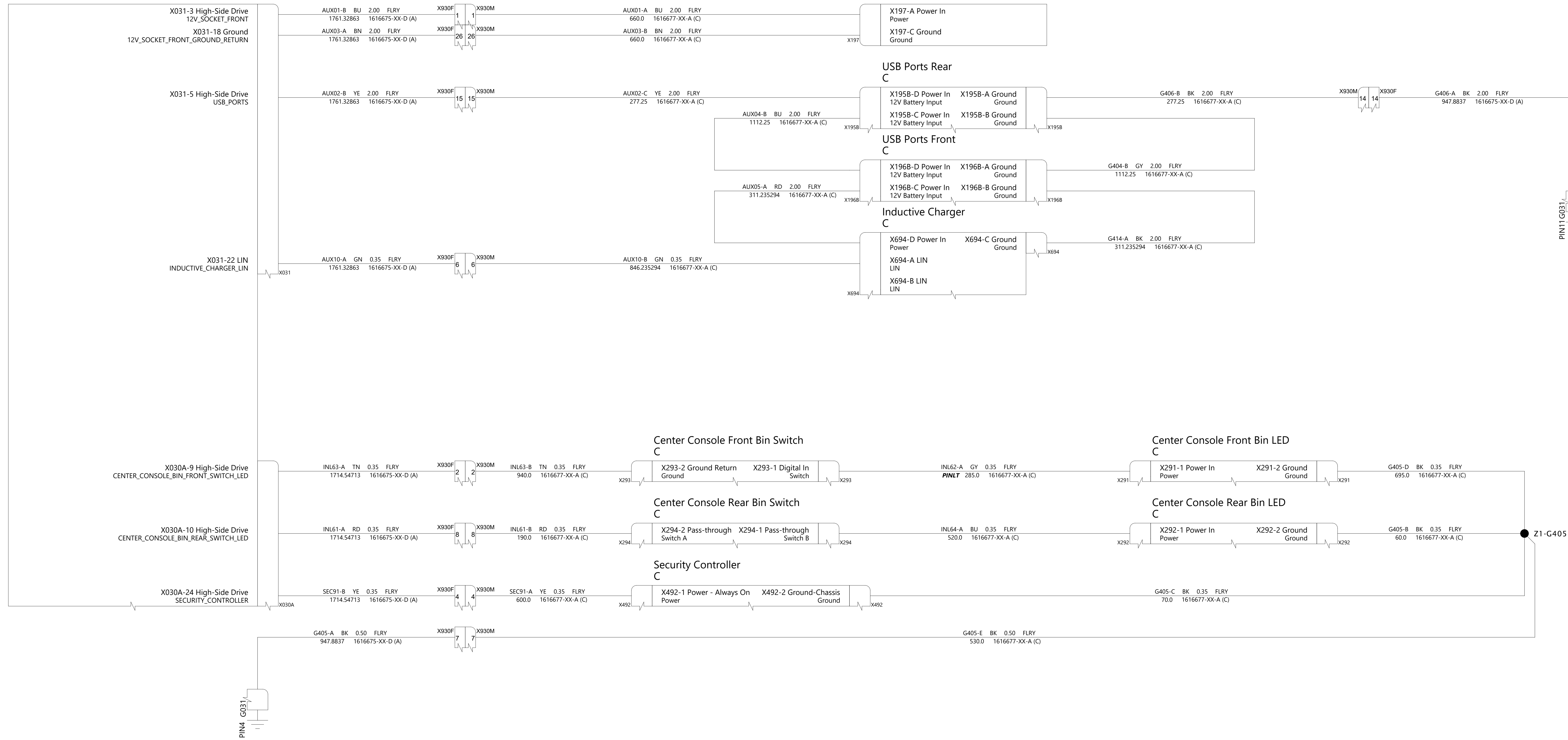

PIN1(G03)

Z1-G405

PIN4(G03)

TESLA

THE INFORMATION CONTAINED HEREIN IS DEEMED TO BE CONFIDENTIAL, PROPRIETARY, AND A TRADE SECRET OF TESLA MOTORS. THIS INFORMATION MAY NOT BE USED, REPRODUCED, OR DISCLOSED AS THE DIRECT OR INDIRECT BASIS FOR THE DEVELOPMENT, MANUFACTURE, OR SALE OF PROCESSES OR PRODUCTS WITHOUT THE EXPRESSED WRITTEN CONSENT OF TESLA MOTORS.

DRAWN	CHECKED	APPROVED
-------	---------	----------

MATERIAL AS SPECIFIED	FINISHING AS SPECIFIED	SCALE NONE
--------------------------	---------------------------	---------------

PART NAME
Center Console

PART NUMBER	REV	SHEET	SIZE
	1	11 of 54	A0

Body Controller Left
A,D,J,W X036 X030A X030B X031 X039 X037 X033A X033B X032 X035 X038

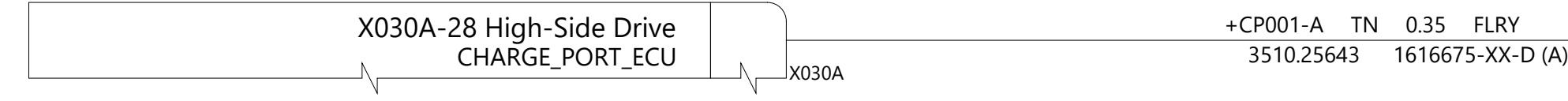

Charge Port ECU
A X096 X688 X687

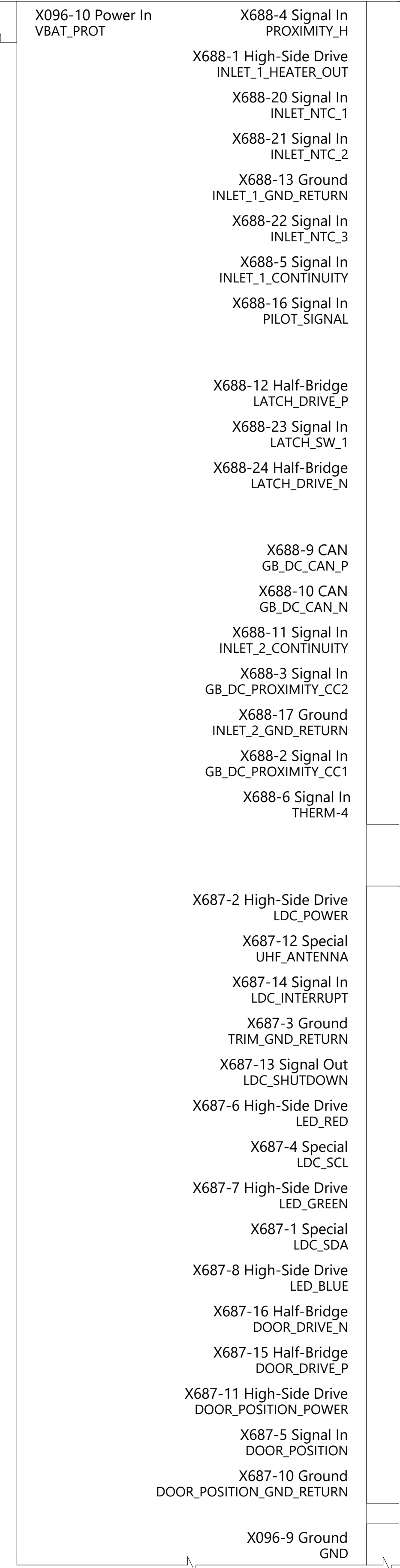

Charge Port Inlet
A

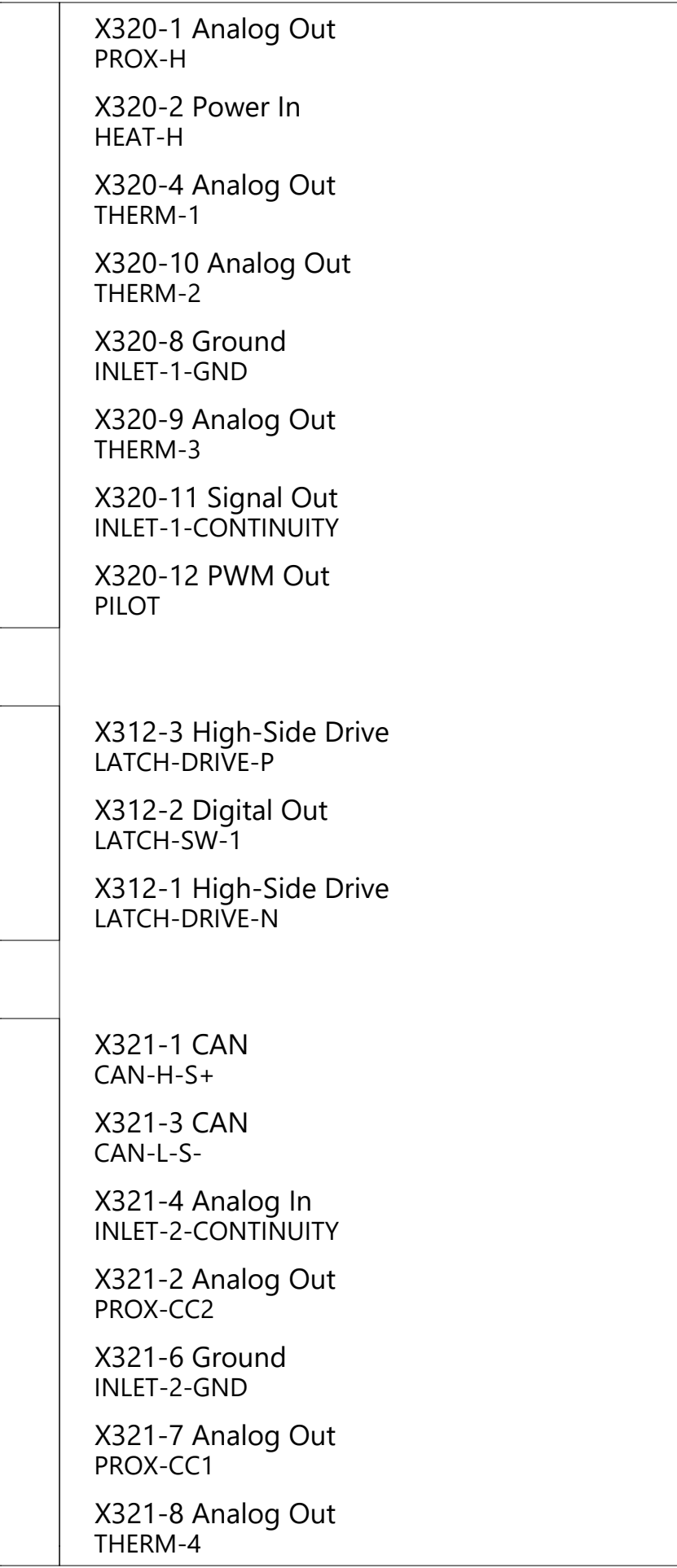

Charge Port Door
Z

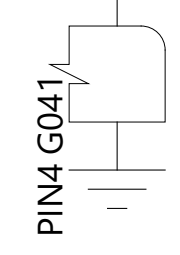
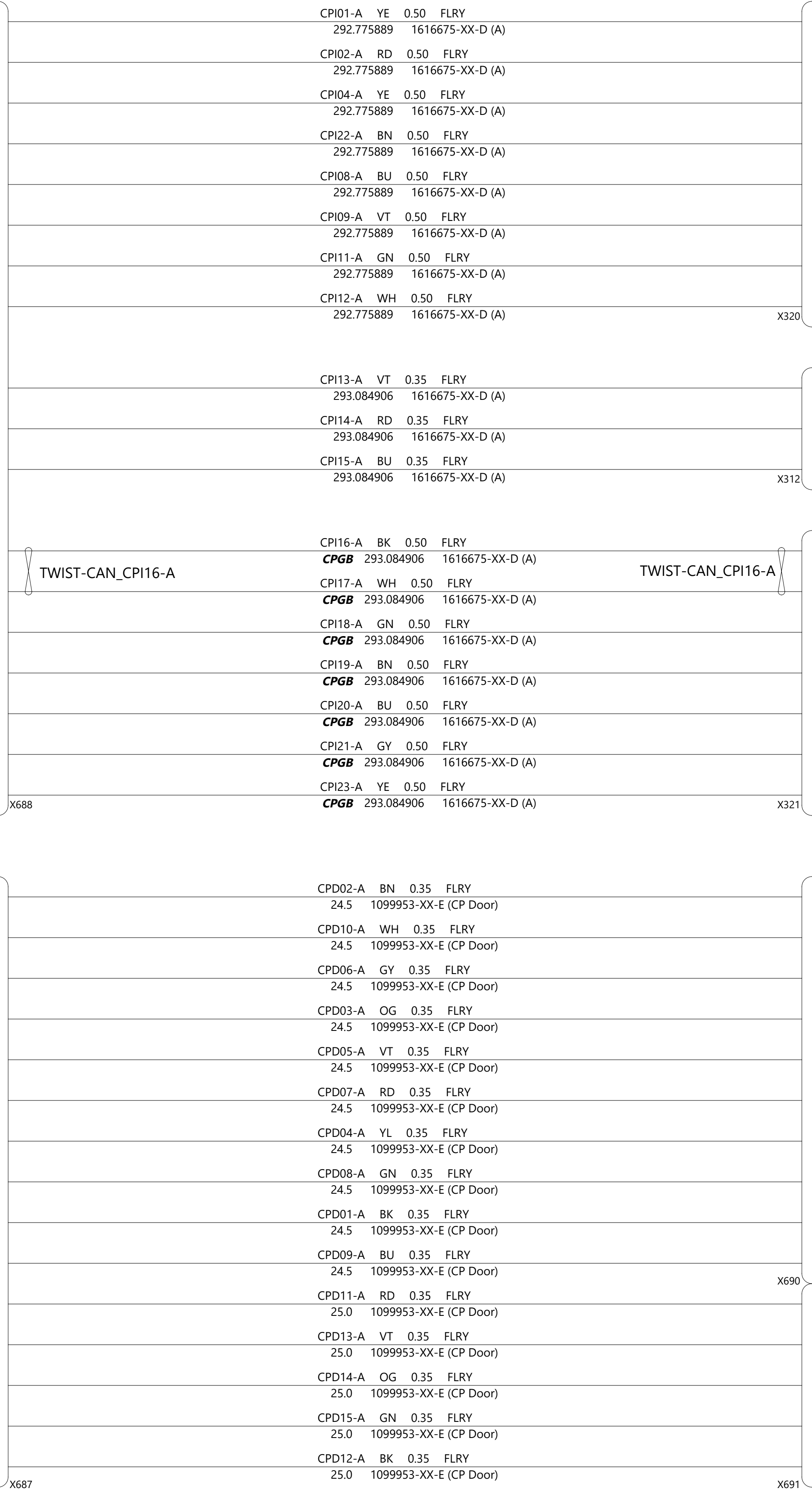
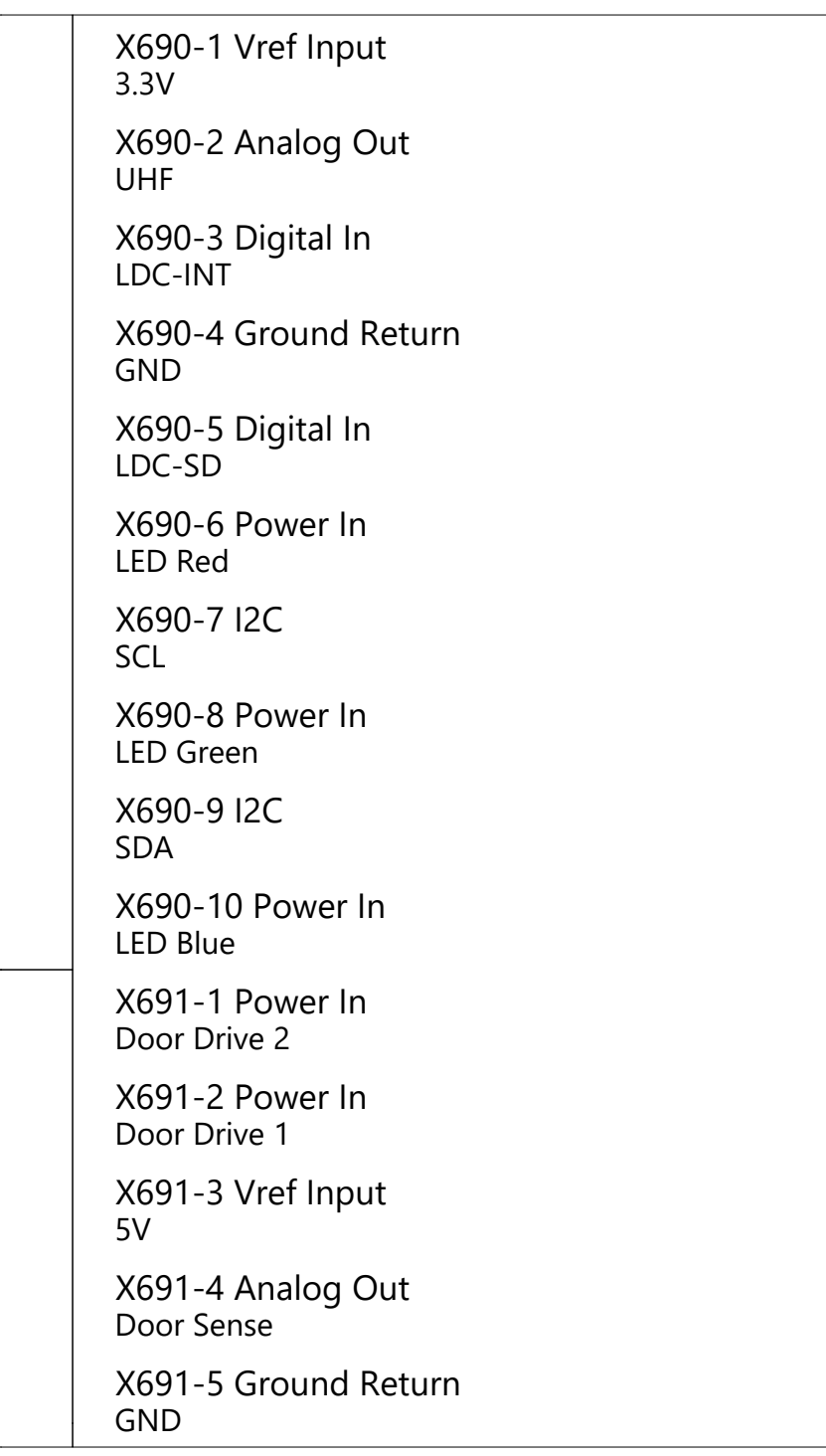

TESLA

THE INFORMATION CONTAINED HEREIN IS DEEMED TO BE CONFIDENTIAL, PROPRIETARY, AND A TRADE SECRET OF TESLA MOTORS. THIS INFORMATION MAY NOT BE USED, REPRODUCED, OR DISCLOSED AS THE OBJECT OR INSTRUMENT BASIS FOR THE DEVELOPMENT, MANUFACTURE, OR SALE OF PROCESSES OR PRODUCTS WITHOUT THE EXPRESSED WRITTEN CONSENT OF TESLA MOTORS.

DRAWN	CHECKED	APPROVED
-------	---------	----------

MATERIAL AS SPECIFIED	FINISHING AS SPECIFIED	SCALE NONE
--------------------------	---------------------------	---------------

PART NAME
Charge Port Inlet

PART NUMBER	REV	SHEET	SIZE
	1	12 of 54	A0

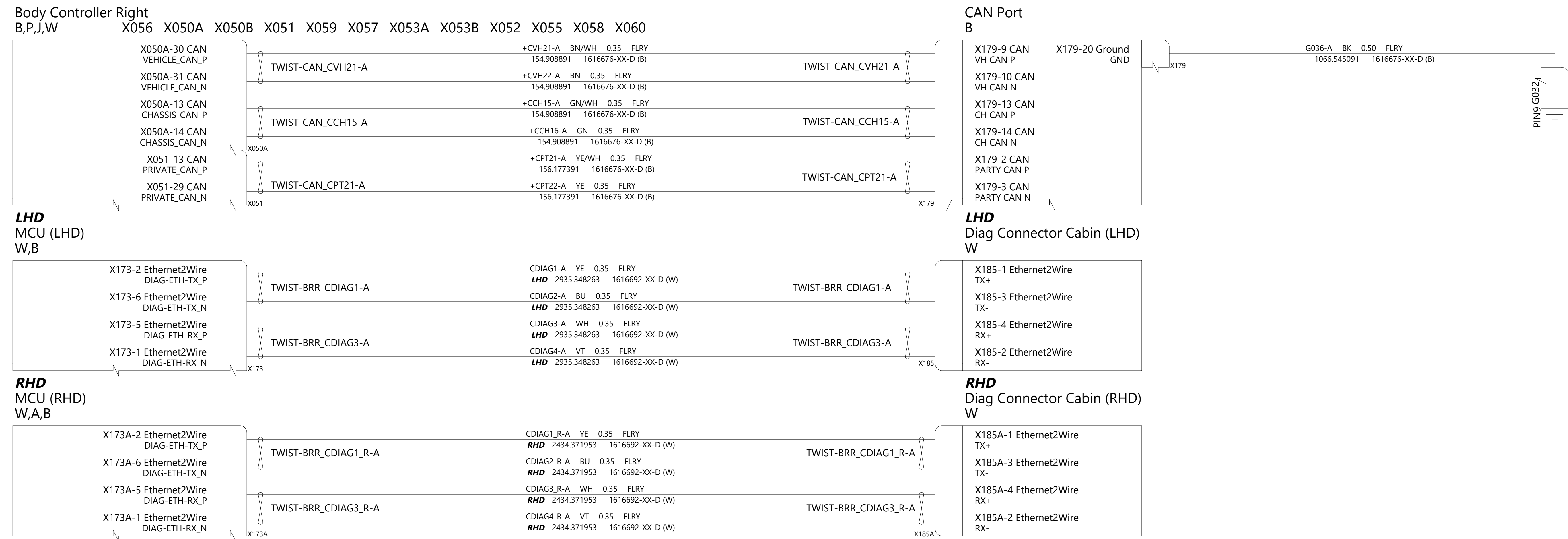

TESLA

THE INFORMATION CONTAINED HEREIN IS DEEMED TO BE CONFIDENTIAL, PROPRIETARY, AND A TRADE SECRET OF TESLA MOTORS. THIS INFORMATION MAY NOT BE USED, REPRODUCED, OR DISCLOSED AS THE DIRECT OR INDIRECT BASIS FOR THE DEVELOPMENT, MANUFACTURE, OR SALE OF PROCESSES OR PRODUCTS WITHOUT THE EXPRESSED WRITTEN CONSENT OF TESLA MOTORS.

DRAWN	CHECKED	APPROVED
MATERIAL AS SPECIFIED	FINISHING AS SPECIFIED	SCALE NONE
PART NAME Diagnostics		
PART NUMBER	REV	SHEET
	1	13 of 54
		SIZE A0

Body Controller Left
A,D,J,W X036 X030A X030B X031 X039 X037 X033A X033B X032 X035 X038

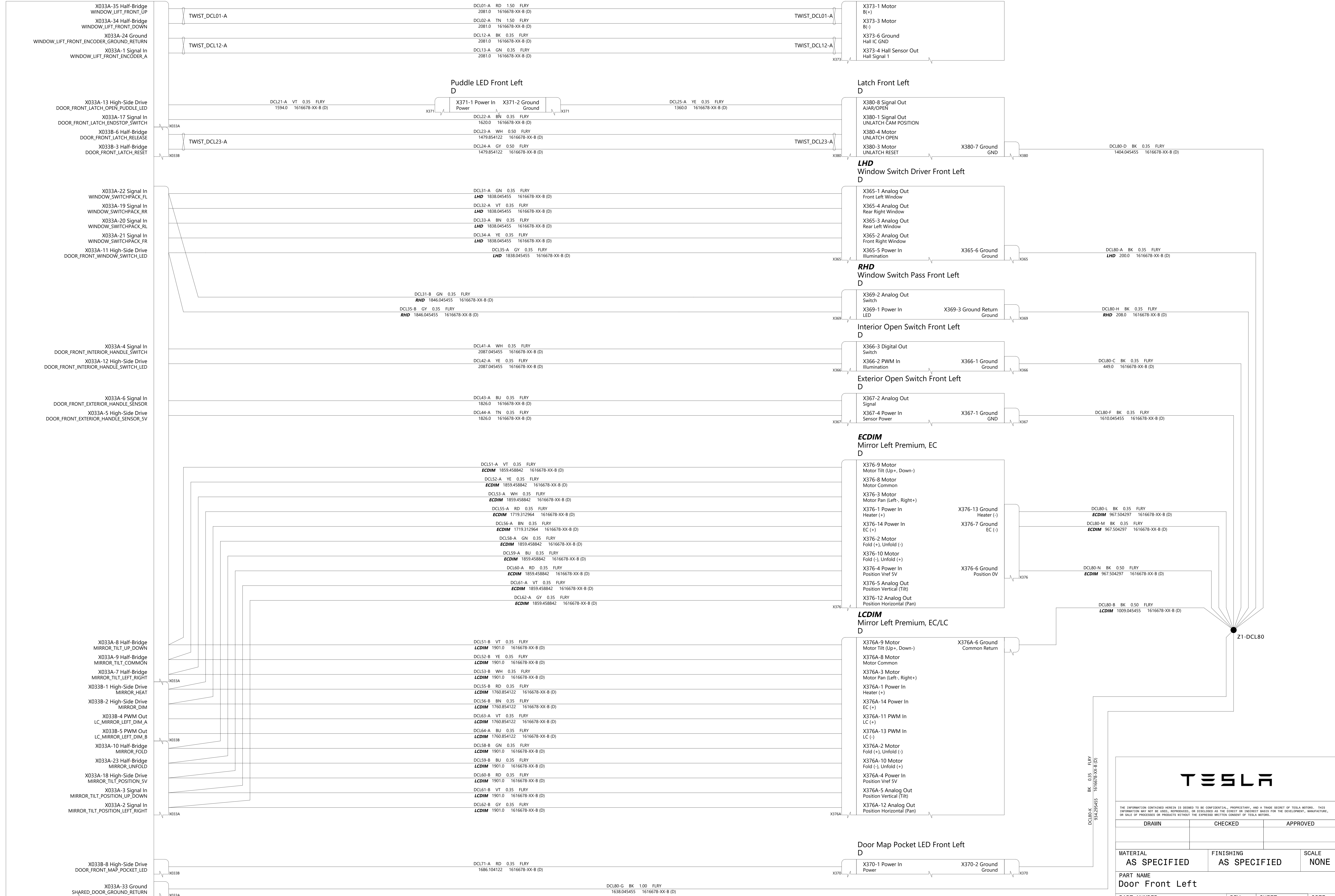

THE INFORMATION CONTAINED HEREIN IS DEEMED TO BE CONFIDENTIAL, PROPRIETARY, AND A TRADE SECRET OF TESLA MOTORS. THIS INFORMATION MAY NOT BE USED, REPRODUCED, OR DISCLOSED AS THE DIRECT OR INDIRECT BASIS FOR THE DEVELOPMENT, MANUFACTURE, OR SALE OF PROCESSES OR PRODUCTS WITHOUT THE EXPRESSED WRITTEN CONSENT OF TESLA MOTORS.

DRAWN	CHECKED	APPROVED
MATERIAL AS SPECIFIED	FINISHING AS SPECIFIED	SCALE NONE
PART NAME Door Front Left		
PART NUMBER	REV	SHEET
	1	14 OF 54
		SIZE A0

Body Controller Right
B,P,J,W X056 X050A X051 X059 X057 X053A X053B X052 X055 X058 X060

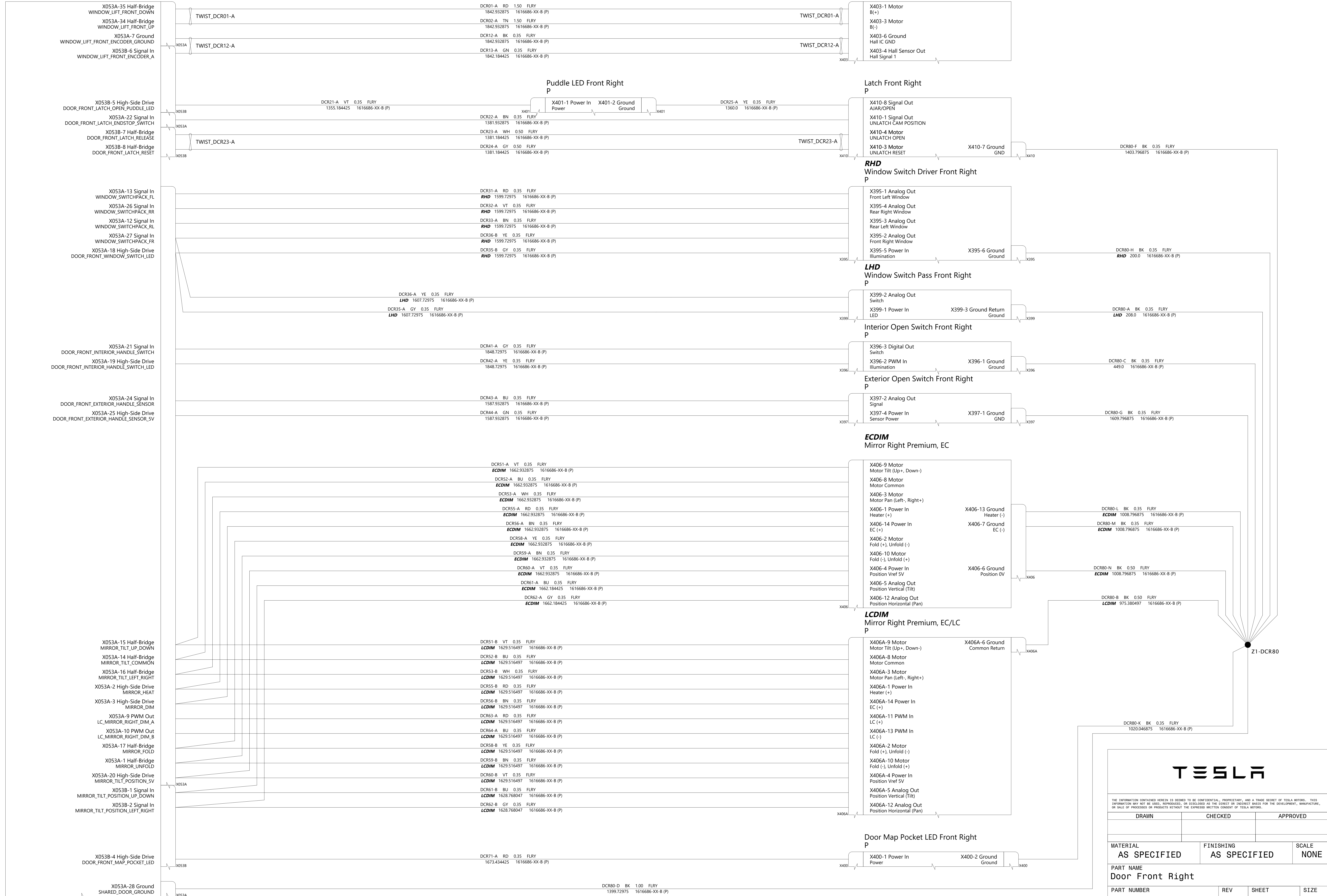

THE INFORMATION CONTAINED HEREIN IS DEEMED TO BE CONFIDENTIAL, PROPRIETARY, AND A TRADE SECRET OF TESLA MOTORS. THIS INFORMATION MAY NOT BE USED, REPRODUCED, OR DISCLOSED AS THE DIRECT OR INDIRECT BASIS FOR THE DEVELOPMENT, MANUFACTURE, OR SALE OF PROCESSES OR PRODUCTS WITHOUT THE EXPRESSED WRITTEN CONSENT OF TESLA MOTORS.

DRAWN	CHECKED	APPROVED
MATERIAL AS SPECIFIED	FINISHING AS SPECIFIED	SCALE NONE
PART NAME Door Front Right		
PART NUMBER	REV	SHEET
	1	15 of 54
		SIZE A0

Body Controller Left
A,D,J,W X036 X030A X030B X031 X039 X037 X033A X033B X032 X035 X038

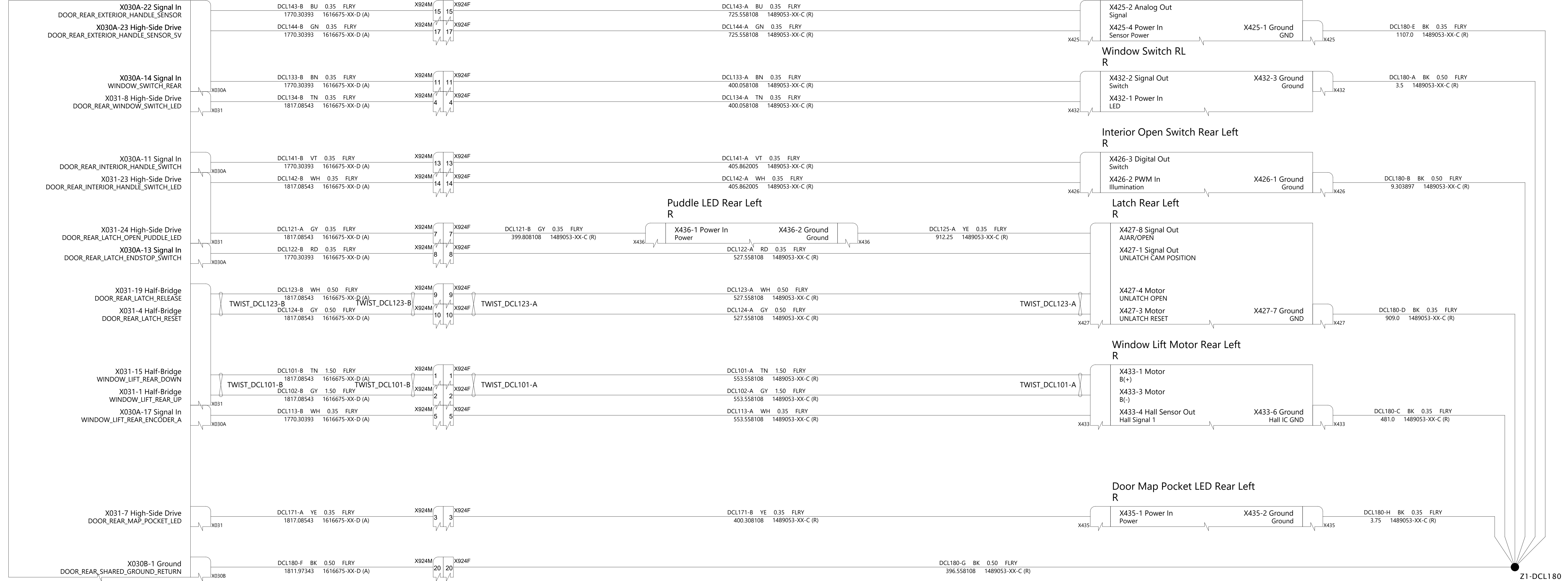

Body Controller Right
B,P,J,W X056 X050A X050B X051 X059 X057 X053A X053B X052 X055 X058 X060

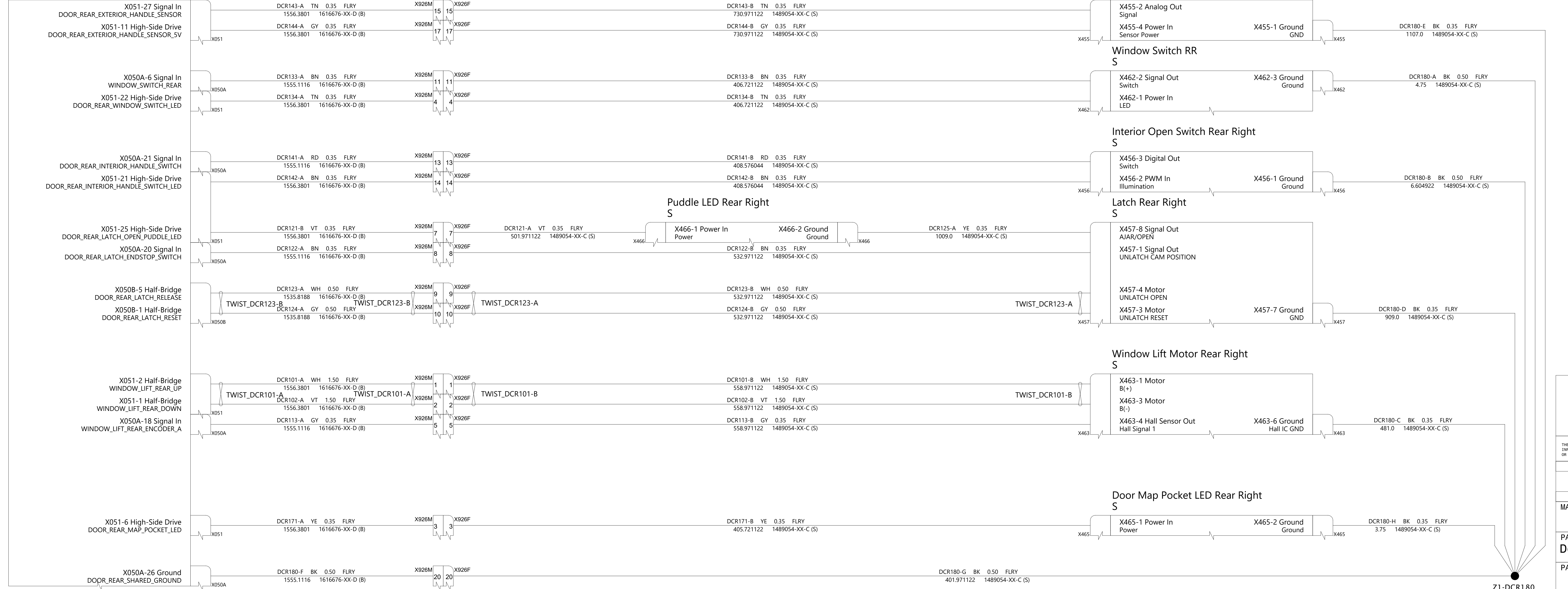

TESLA

THE INFORMATION CONTAINED HEREIN IS DEEMED TO BE CONFIDENTIAL, PROPRIETARY, AND A TRADE SECRET OF TESLA MOTORS. THIS INFORMATION MAY NOT BE USED, REPRODUCED, OR DISCLOSED AS THE DIRECT OR INDIRECT BASIS FOR THE DEVELOPMENT, MANUFACTURE, OR SALE OF PROCESSES OR PRODUCTS WITHOUT THE EXPRESSED WRITTEN CONSENT OF TESLA MOTORS.

DRAWN	CHECKED	APPROVED
MATERIAL AS SPECIFIED	FINISHING AS SPECIFIED	SCALE NONE
PART NAME Doors Rear		
PART NUMBER	REV 1	SHEET 16 of 54
		SIZE A0

Body Controller Front
W,U X021 X012 X011 X010 X015 X014

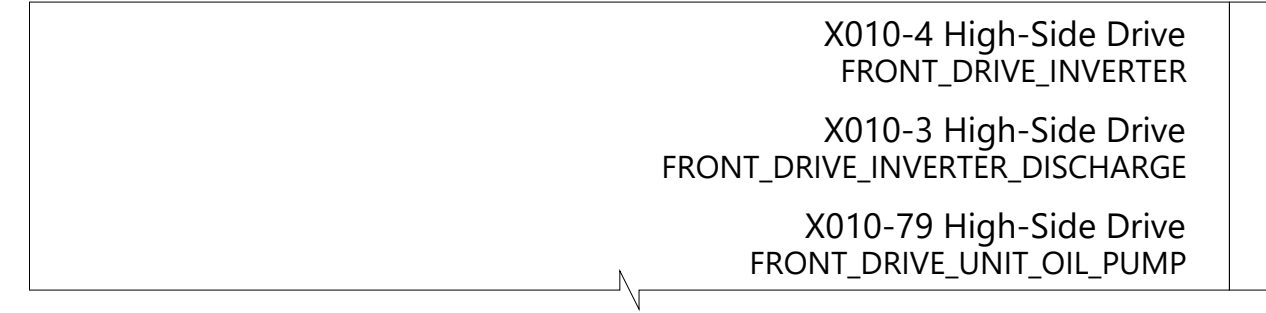

AWD Drive Inverter Front & Resolver
N X093 X094

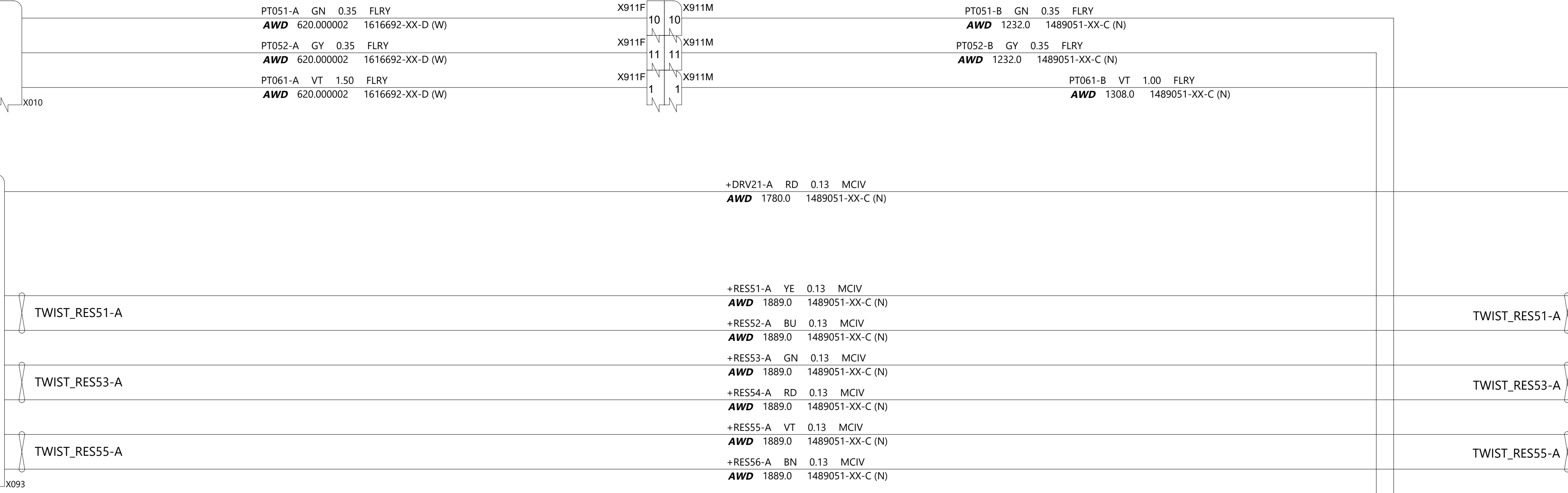
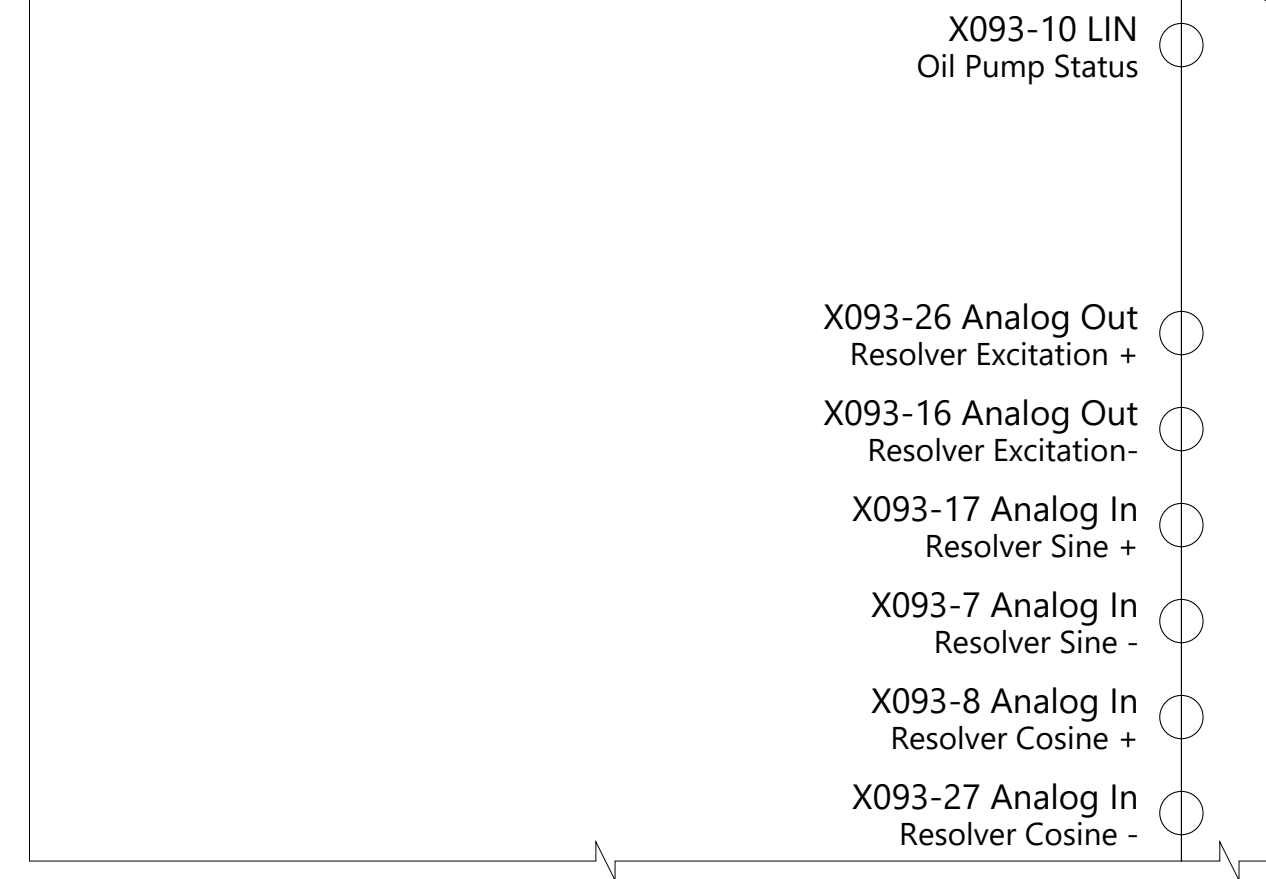

AWD Drive Unit Oil Pump Front
N

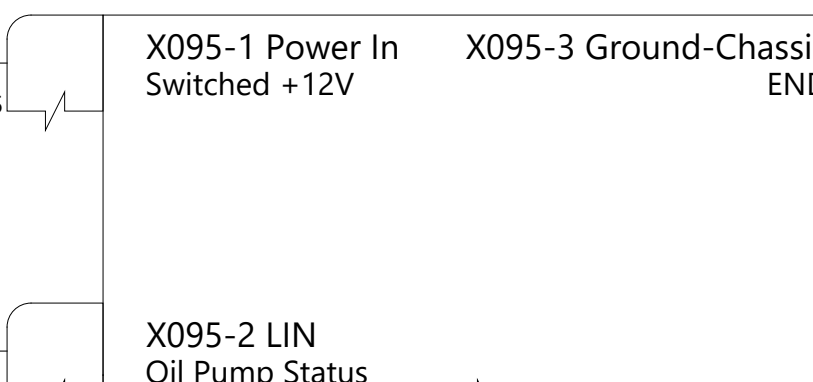

AWD Drive Inverter Front & Resolver
N X093 X094

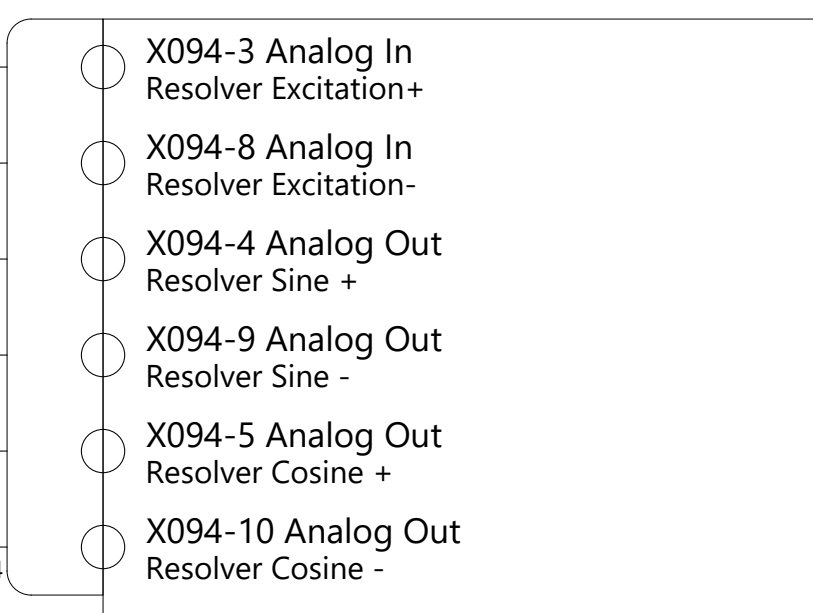

Drive Inverter Rear & Resolver
X X090 X091

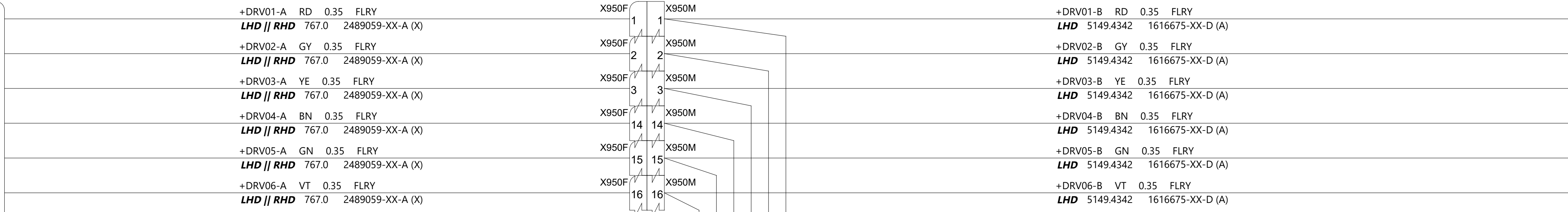

LHD Accel Pedal Sensor (LHD)
A

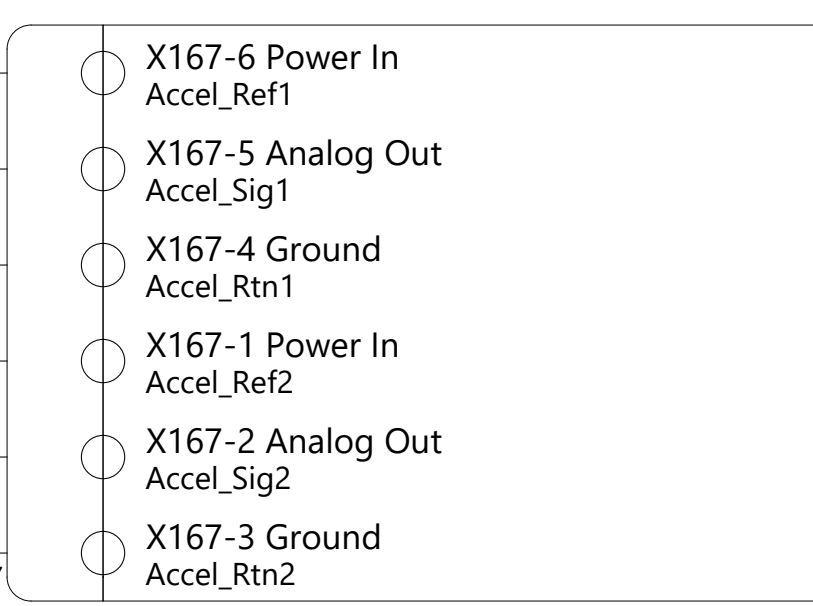

RHD Accel Pedal Sensor (RHD)
B

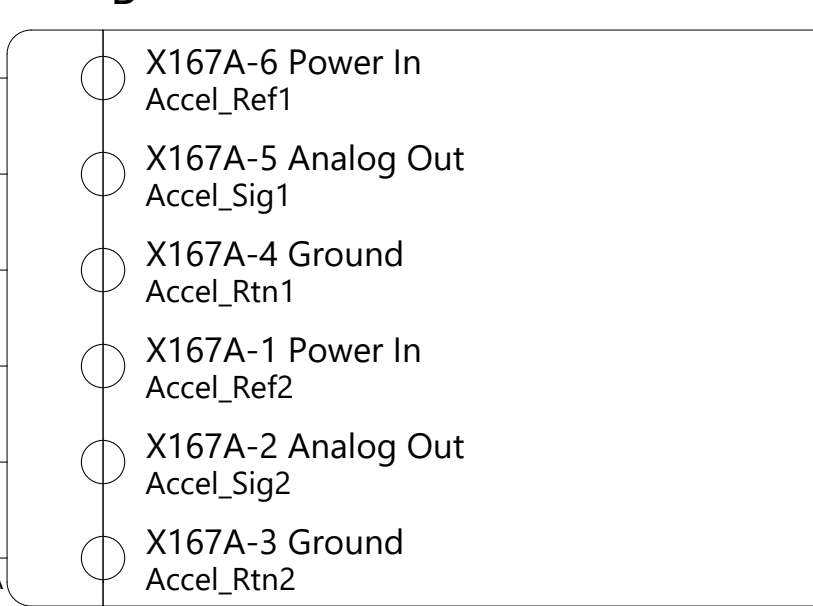

Drive Inverter Rear & Resolver
X X090 X091

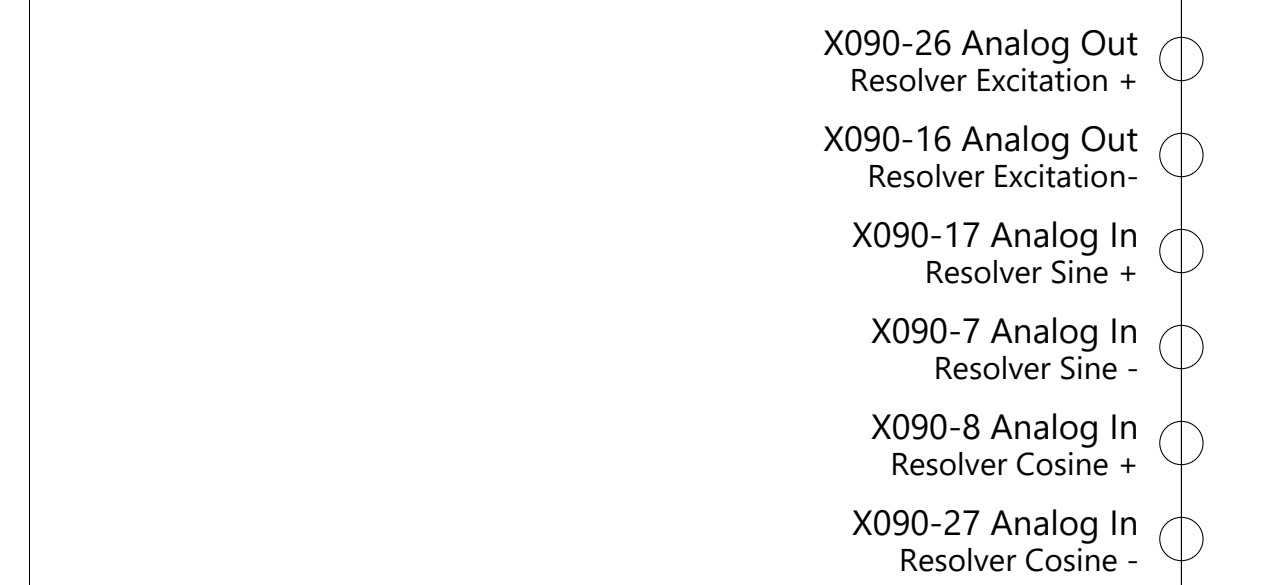
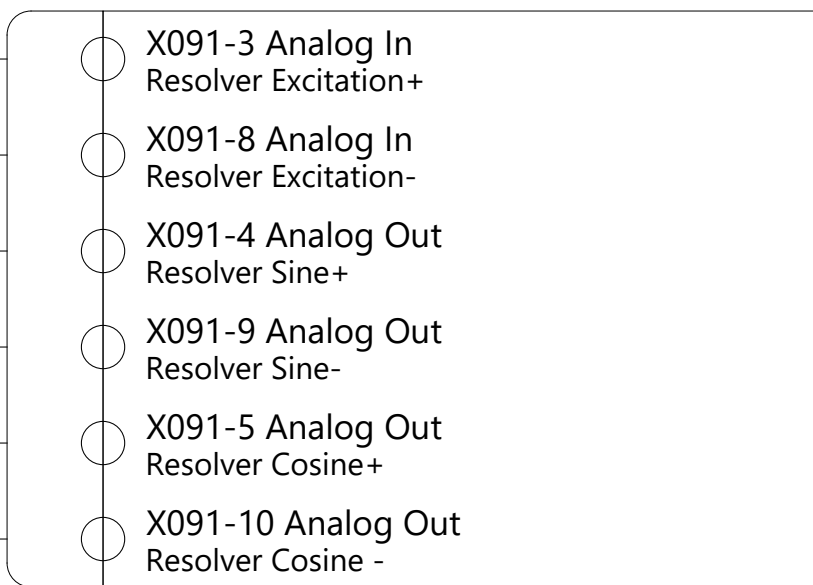

Body Controller Left
A,D,J,W X036 X030A X030B X031 X039 X037 X033A X033B X032 X035 X038

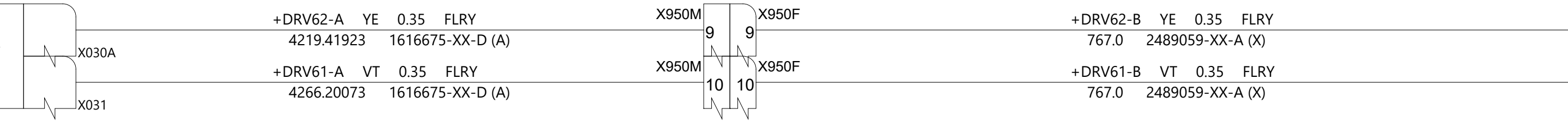

Drive Unit Oil Pump Rear
X

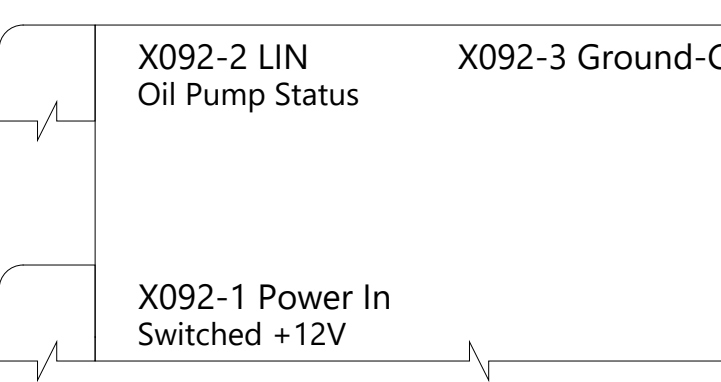

Body Controller Right
B,P,J,W X056 X050A X050B X051 X059 X057 X053A X053B X052 X055 X058 X060



THE INFORMATION CONTAINED HEREIN IS DEEMED TO BE CONFIDENTIAL, PROPRIETARY, AND A TRADE SECRET OF TESLA MOTORS. THIS INFORMATION MAY NOT BE USED, REPRODUCED, OR DISCLOSED AS THE DIRECT OR INDIRECT BASIS FOR THE DEVELOPMENT, MANUFACTURE, OR SALE OF PROCESSES OR PRODUCTS WITHOUT THE EXPRESS WRITTEN CONSENT OF TESLA MOTORS.

DRAWN	CHECKED	APPROVED
MATERIAL AS SPECIFIED	FINISHING AS SPECIFIED	SCALE NONE
PART NAME Drive Inverters		
PART NUMBER	REV	SHEET
	1	17 of 54
		SIZE A0

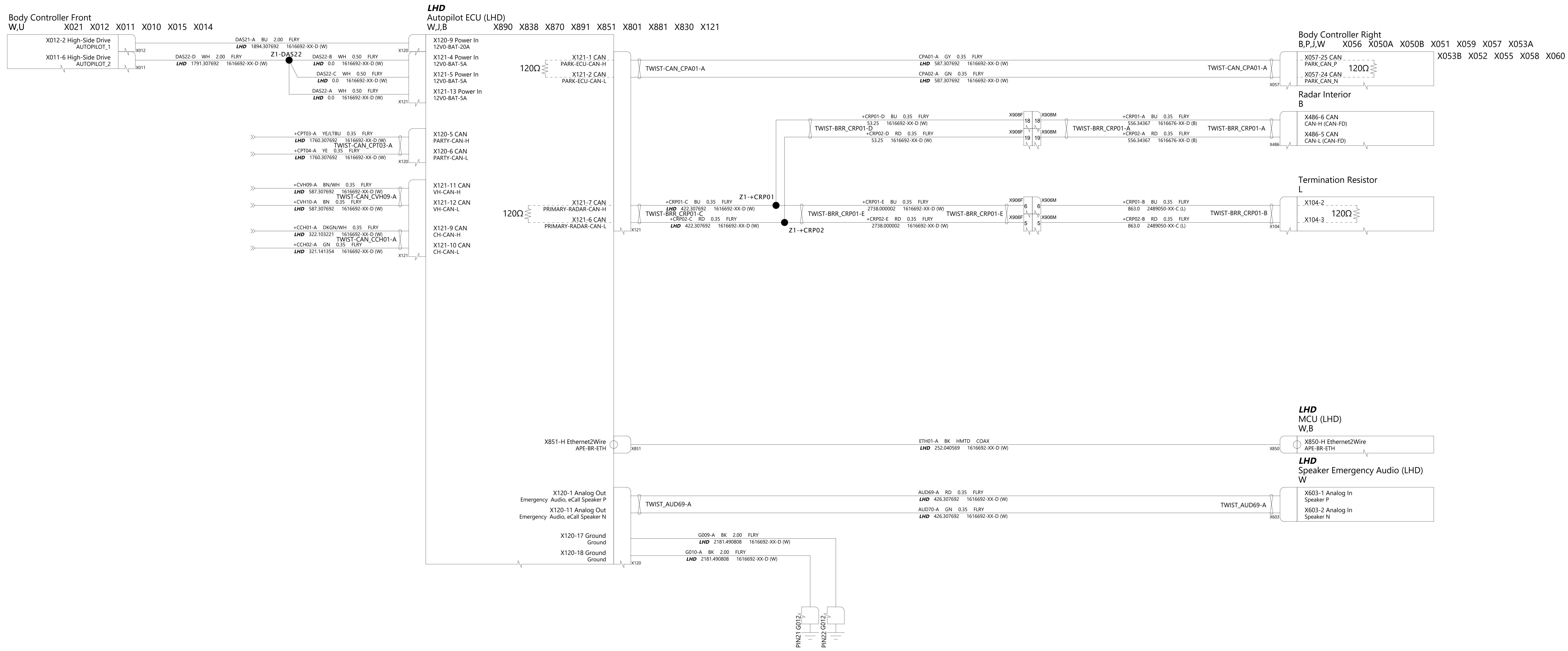

THE INFORMATION CONTAINED HEREIN IS DEEMED TO BE CONFIDENTIAL, PROPRIETARY, AND A TRADE SECRET OF TESLA MOTORS. THIS INFORMATION MAY NOT BE USED, REPRODUCED, OR DISCLOSED AS THE DIRECT OR INDIRECT BASIS FOR THE DEVELOPMENT, MANUFACTURE, OR SALE OF PROCESSES OR PRODUCTS WITHOUT THE EXPRESSED WRITTEN CONSENT OF TESLA MOTORS.

DRAWN	CHECKED	APPROVED
MATERIAL AS SPECIFIED	FINISHING AS SPECIFIED	SCALE NONE
PART NAME Driver Assistance		
PART NUMBER	REV	SHEET
	1	18 of 54
		SIZE A0

Body Controller Front
W,U X021 X012 X011 X010 X015 X014

RHD
Autopilot ECU (RHD)
W,J,B

Body Controller Right
B,P,J,W X056 X056 X050A X050B X051 X059 X057 X053A X053B X052 X055

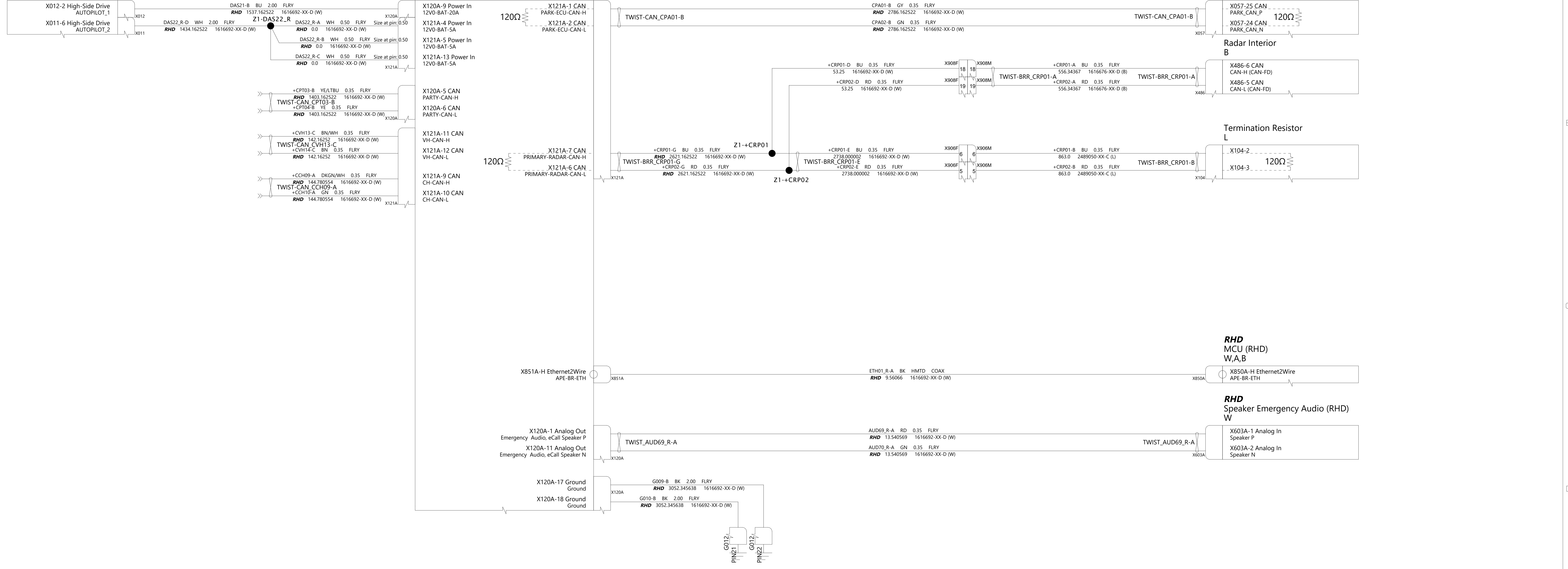

TESLA

THE INFORMATION CONTAINED HEREIN IS DEEMED TO BE CONFIDENTIAL, PROPRIETARY, AND A TRADE SECRET OF TESLA MOTORS. THIS INFORMATION MAY NOT BE USED, REPRODUCED, OR DISCLOSED AS THE DIRECT OR INDIRECT BASIS FOR THE DEVELOPMENT, MANUFACTURE, OR SALE OF PROCESSES OR PRODUCTS WITHOUT THE EXPRESSED WRITTEN CONSENT OF TESLA MOTORS.

DRAWN	CHECKED	APPROVED
MATERIAL AS SPECIFIED	FINISHING AS SPECIFIED	SCALE NONE
PART NAME Driver Assistance, RHD		
PART NUMBER	REV 1	SHEET 19 OF 54
		SIZE A0

Body Controller Front
W,U X021 X012 X011 X010 X015 X014

X012-3 High-Side Drive
WINDSHIELD_WIPER_POWER

X010-45 LIN
WINDSHIELD_WIPER_LIN

X010-53 Signal In
WINDSHIELD_WASHER_FLUID_LEVEL_SWITCH

X010-80 High-Side Drive
WINDSHIELD_WASHER_FLUID_PUMP

X010-90 High-Side Drive
WINDSHIELD_UPPER_GLASS_HEATER

X010-89 High-Side Drive
WINDSHIELD_WIPER_PARK_HEATER

X010-48 Signal In
FRUNK_EMERGENCY_RELEASE_SWITCH

X010-1 High-Side Drive
FRUNK_LED

X010-64 Ground
FRUNK_EMERGENCY_RELEASE_SWITCH_RETURN

X010-83 Half-Bridge
FRUNK_LATCH_PRIMARY_RELEASE

X010-82 Half-Bridge
FRUNK_LATCH_PRIMARY_RESET

X010-56 Signal In
FRUNK_LATCH_SWITCH_1

X010-38 Signal In
FRUNK_LATCH_SWITCH_2

X010-59 Ground
FRUNK_SWITCH_RETURN

X010-84 Special
FRUNK_ACCESS_POST

X010-2 High-Side Drive
HOMELINK_ECU

X010-58 LIN
HOMELINK_ECU_LIN

X010-94 High-Side Drive
HORN_HIGH_TONE

X010-95 High-Side Drive
HORN_LOW_TONE

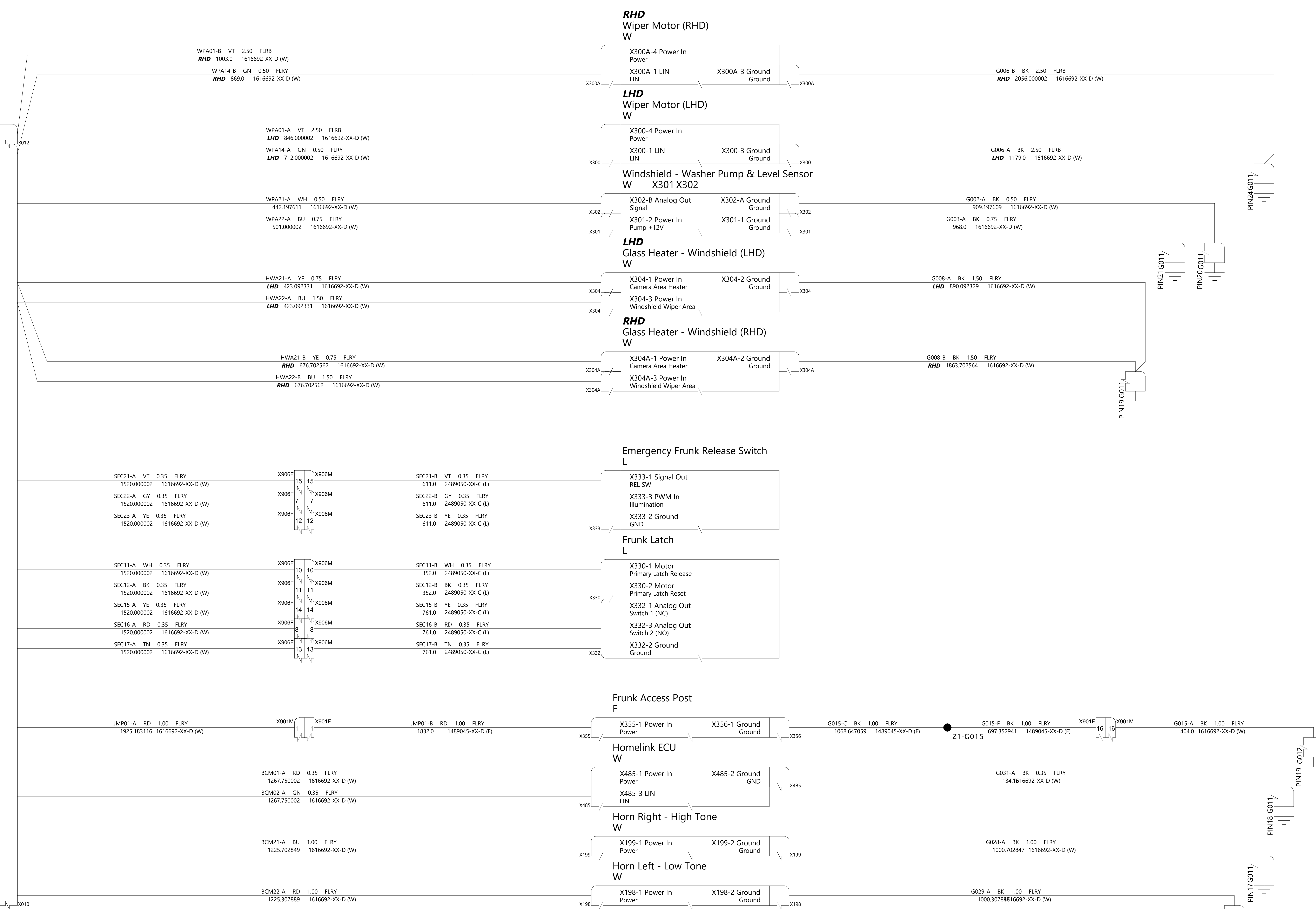

TESLA

THE INFORMATION CONTAINED HEREIN IS DEEMED TO BE CONFIDENTIAL, PROPRIETARY, AND A TRADE SECRET OF TESLA MOTORS. THIS INFORMATION MAY NOT BE USED, REPRODUCED, OR DISCLOSED AS THE DIRECT OR INDIRECT BASIS FOR THE DEVELOPMENT, MANUFACTURE, OR SALE OF PROCESSES OR PRODUCTS WITHOUT THE EXPRESSED WRITTEN CONSENT OF TESLA MOTORS.

DRAWN	CHECKED	APPROVED
MATERIAL AS SPECIFIED	FINISHING AS SPECIFIED	SCALE NONE
PART NAME Frunk Actuator/Sensors		
PART NUMBER	REV	SHEET
	1	20 of 54
		SIZE A0

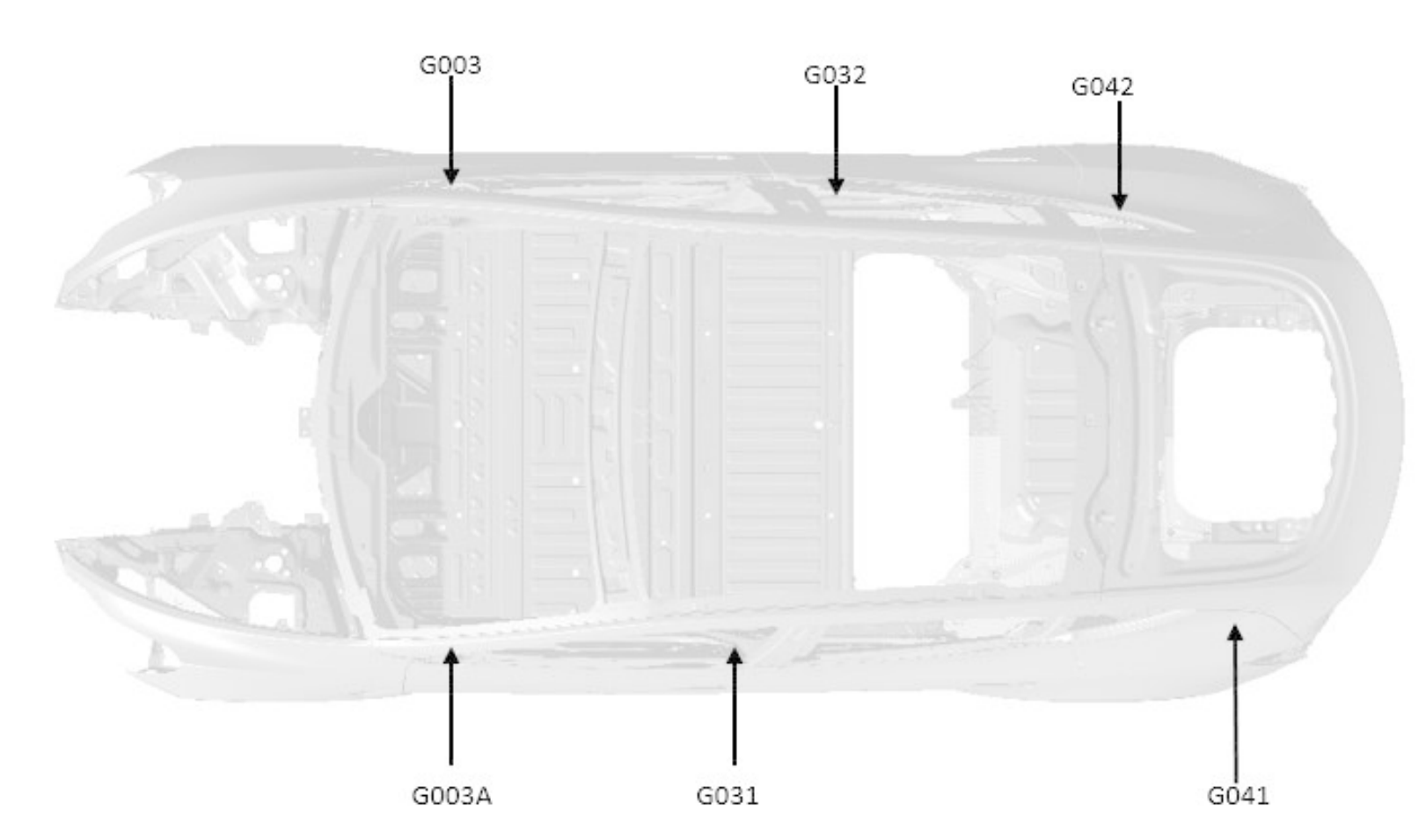
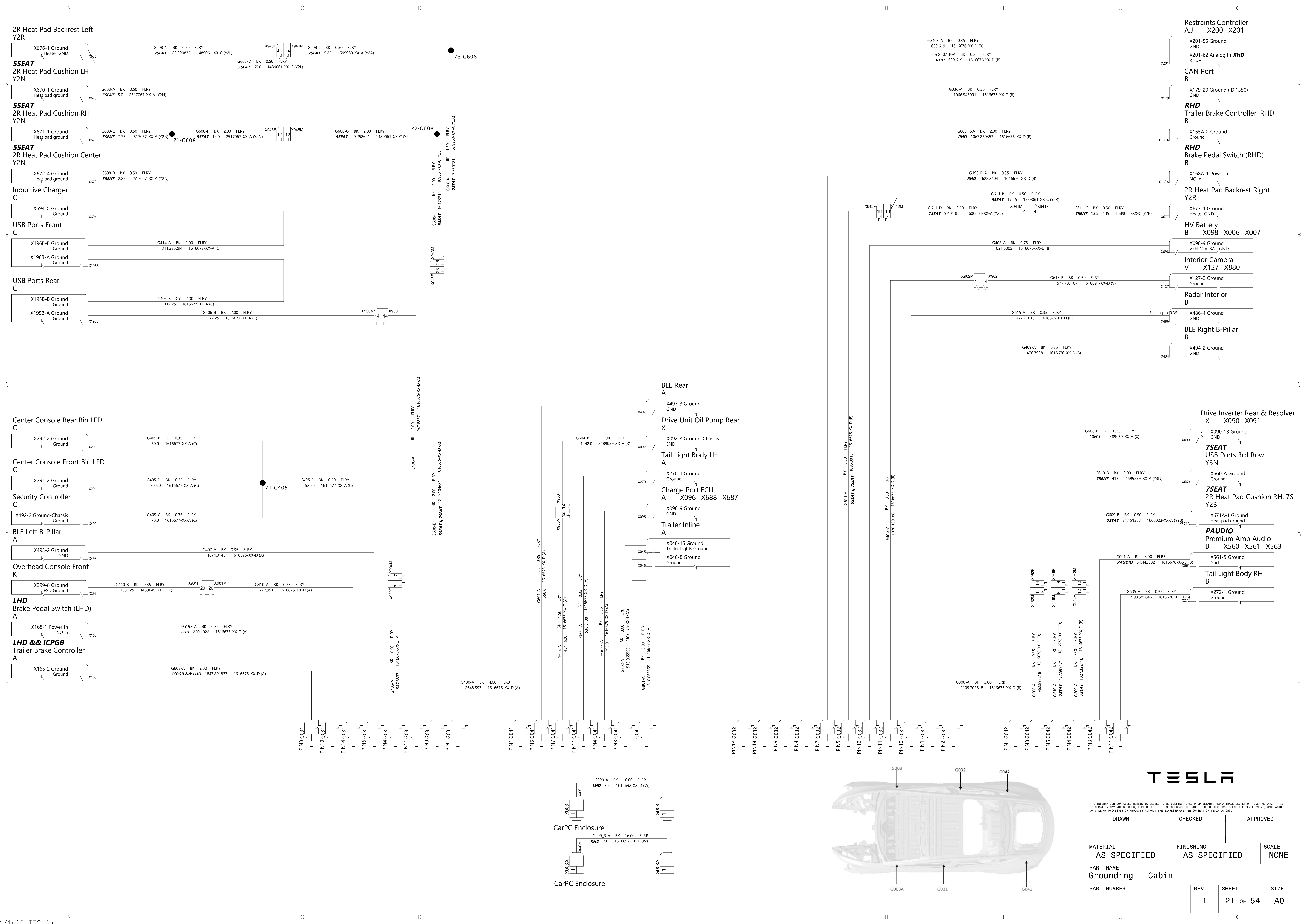

TESLA

THE INFORMATION CONTAINED HEREIN IS DEEMED TO BE CONFIDENTIAL, PROPRIETARY, AND A TRADE SECRET OF TESLA MOTORS. THIS INFORMATION MAY NOT BE USED, REPRODUCED, OR DISCLOSED AS THE DIRECT OR INDIRECT BASIS FOR THE DEVELOPMENT, MANUFACTURE, OR SALE OF PROCESSES OR PRODUCTS WITHOUT THE EXPRESSED WRITTEN CONSENT OF TESLA MOTORS.

DRAWN	CHECKED	APPROVED
MATERIAL AS SPECIFIED	FINISHING AS SPECIFIED	SCALE NONE
PART NAME Grounding - Cabin		
PART NUMBER	REV	SHEET
	1	21 OF 54
		SIZE A0

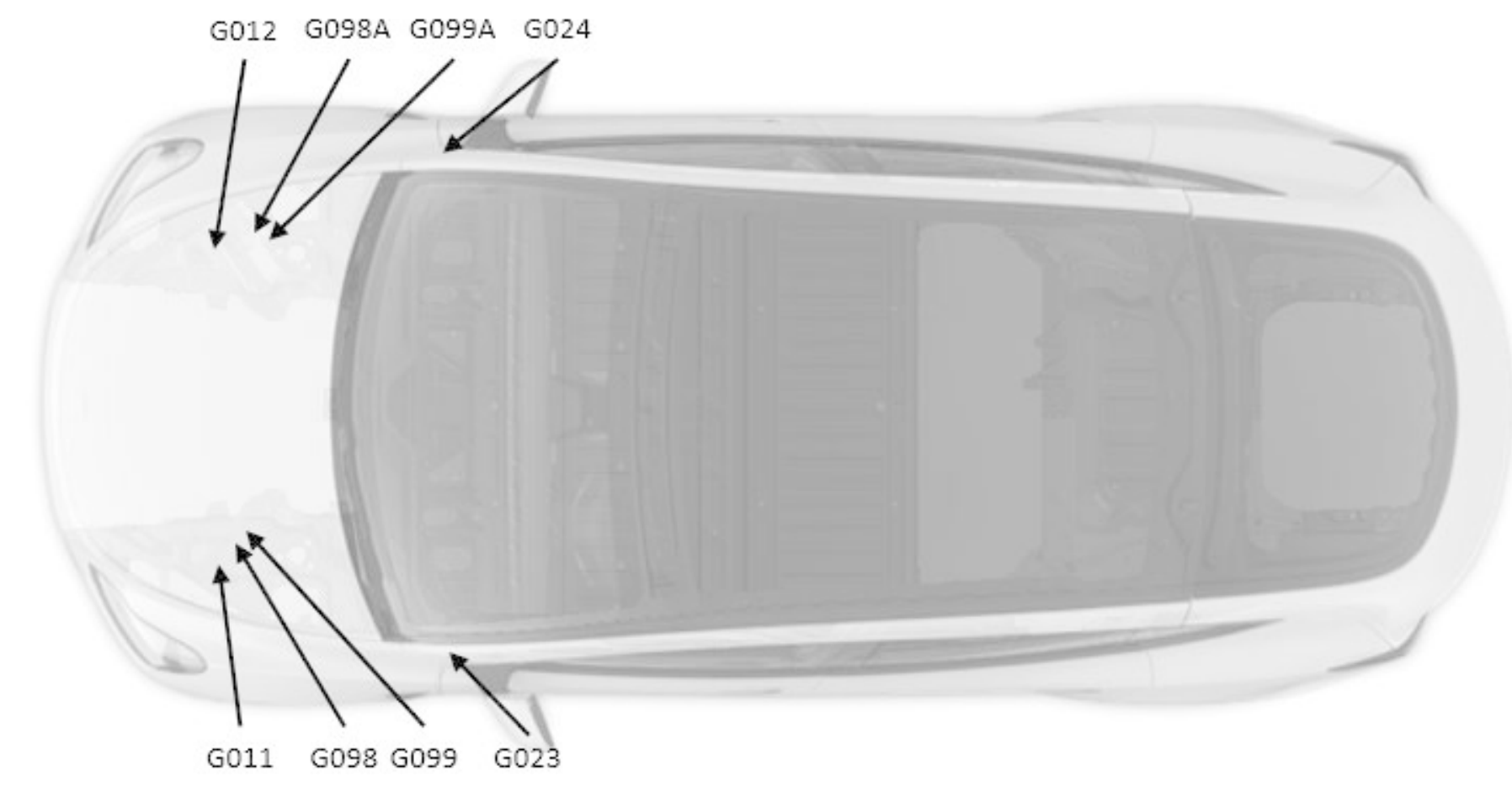
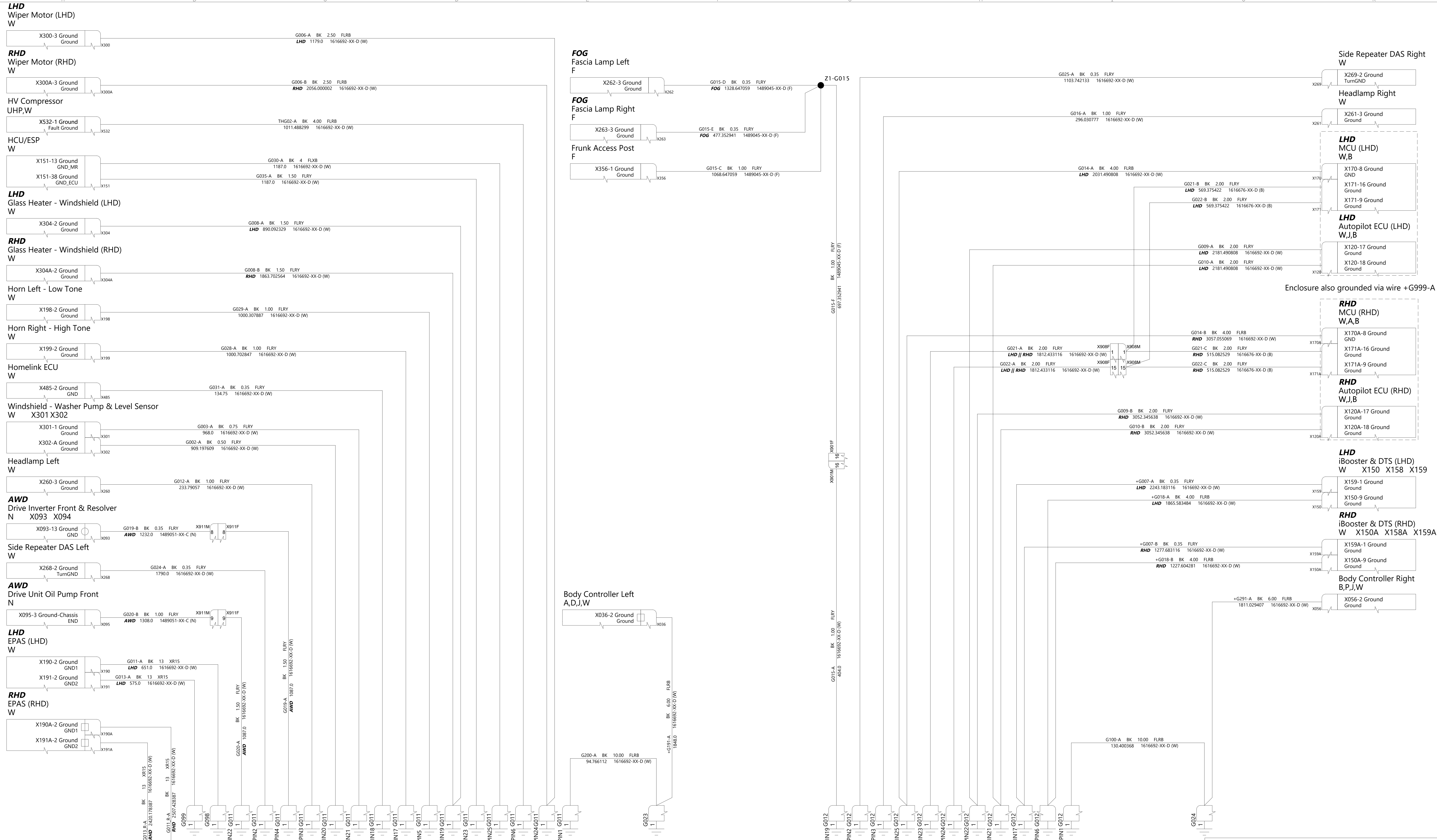

TESLA			
THE INFORMATION CONTAINED HEREIN IS DEEMED TO BE CONFIDENTIAL, PROPRIETARY, AND A TRADE SECRET OF TESLA MOTORS. THIS INFORMATION MAY NOT BE USED, REPRODUCED, OR DISCLOSED AS THE DIRECT OR INDIRECT BASIS FOR THE DEVELOPMENT, MANUFACTURE, OR SALE OF PROCESSES OR PRODUCTS WITHOUT THE EXPRESSED WRITTEN CONSENT OF TESLA MOTORS.			
DRAWN	CHECKED	APPROVED	
MATERIAL AS SPECIFIED		FINISHING AS SPECIFIED	SCALE NONE
PART NAME Grounding - Frunk			
PART NUMBER	REV	SHEET	SIZE
	1	22 OF 54	A0

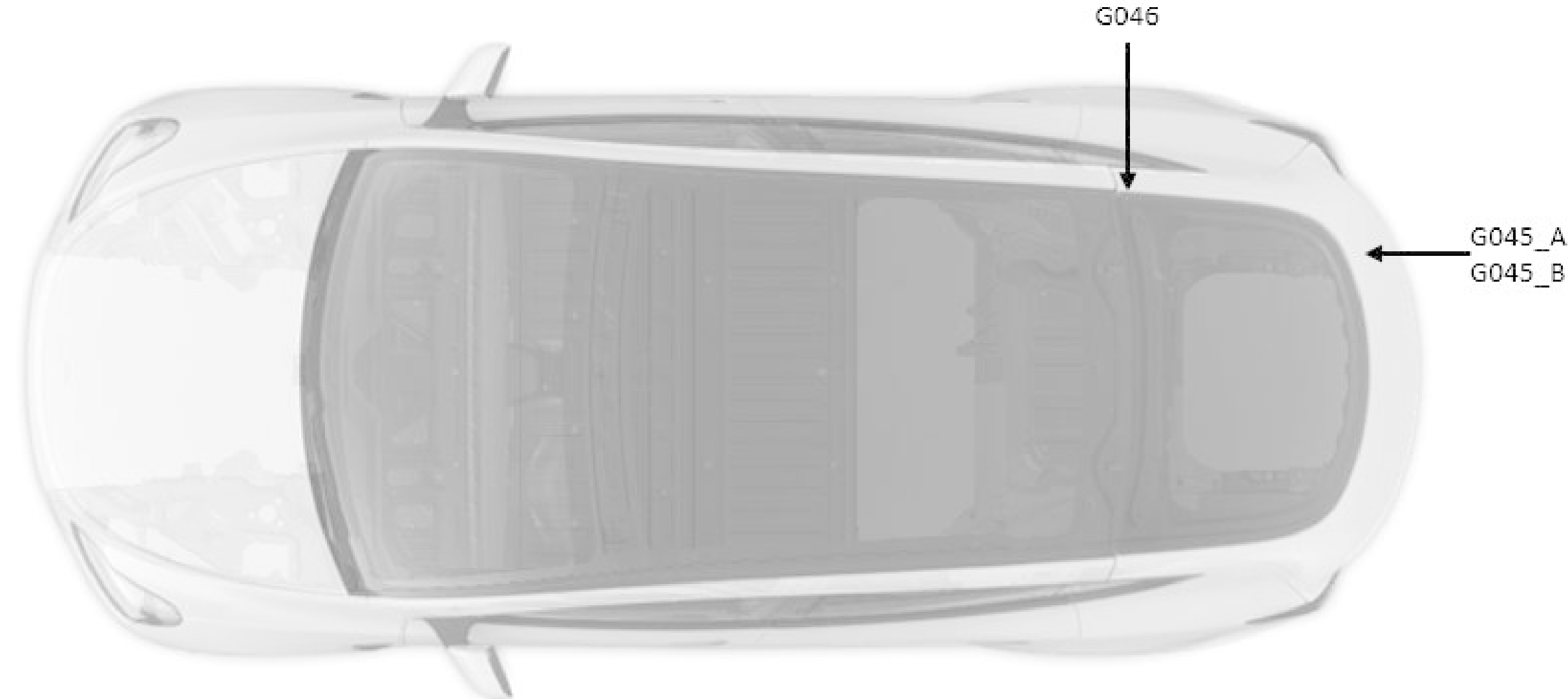
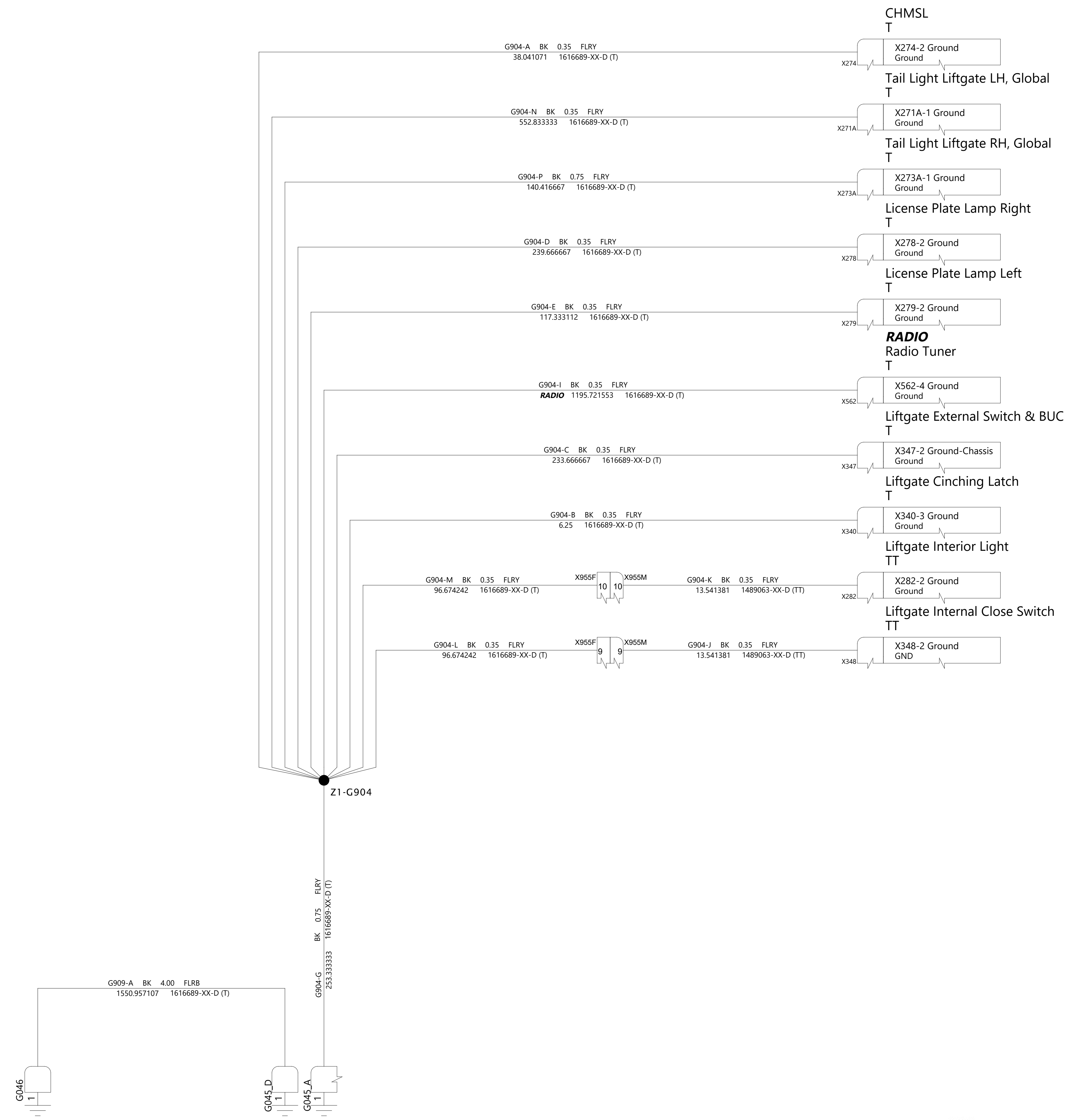

- CHMSL
T
- X274-2 Ground
Ground
- Tail Light Liftgate LH, Global
T
- X271A-1 Ground
Ground
- Tail Light Liftgate RH, Global
T
- X273A-1 Ground
Ground
- License Plate Lamp Right
T
- X278-2 Ground
Ground
- License Plate Lamp Left
T
- X279-2 Ground
Ground
- RADIO
Radio Tuner
T
- X562-4 Ground
Ground
- Liftgate External Switch & BUC
T
- X347-2 Ground-Chassis
Ground
- Liftgate Cinching Latch
T
- X340-3 Ground
Ground
- Liftgate Interior Light
TT
- X282-2 Ground
Ground
- Liftgate Internal Close Switch
TT
- X348-2 Ground
GND

TESLA

THE INFORMATION CONTAINED HEREIN IS DEEMED TO BE CONFIDENTIAL, PROPRIETARY, AND A TRADE SECRET OF TESLA MOTORS. THIS INFORMATION MAY NOT BE USED, REPRODUCED, OR DISCLOSED AS THE DIRECT OR INDIRECT BASIS FOR THE DEVELOPMENT, MANUFACTURE, OR SALE OF PROCESSES OR PRODUCTS WITHOUT THE EXPRESSED WRITTEN CONSENT OF TESLA MOTORS.

DRAWN	CHECKED	APPROVED
-------	---------	----------

MATERIAL AS SPECIFIED	FINISHING AS SPECIFIED	SCALE NONE
--------------------------	---------------------------	---------------

PART NAME
Grounding - Liftgate

PART NUMBER	REV	SHEET	SIZE
	1	23 of 54	A0

Body Controller Left
A,D,J,W

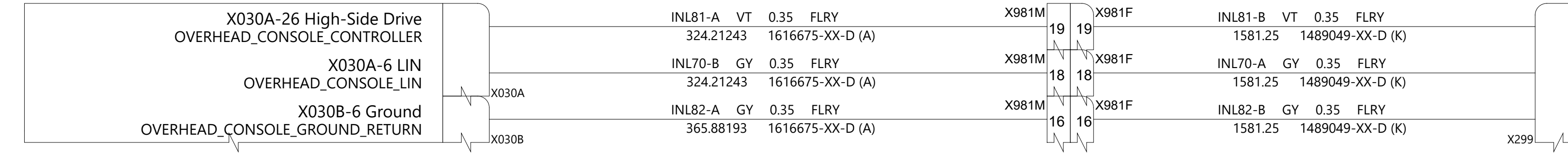

Overhead Console Front
K



Vanity LED Right
K



Vanity LED Left
K

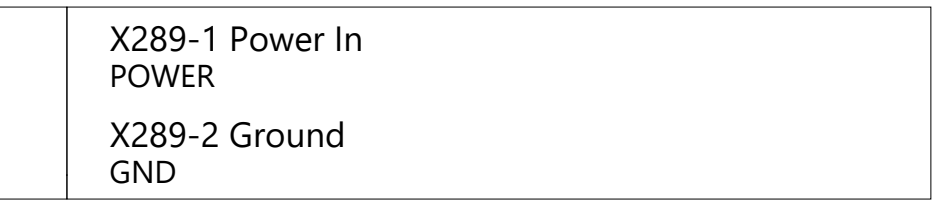

Rear Maplight RH
K

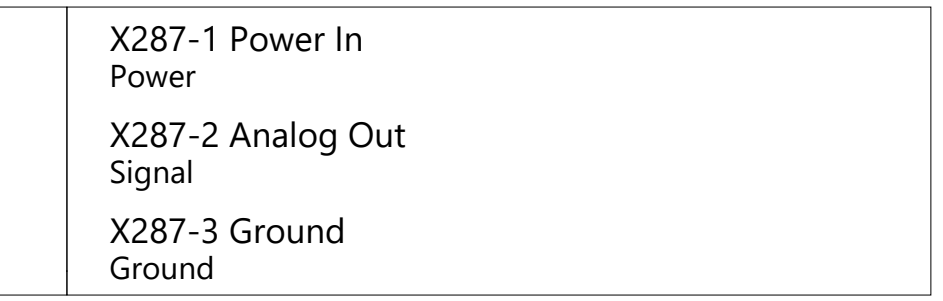

Rear Maplight LH
K

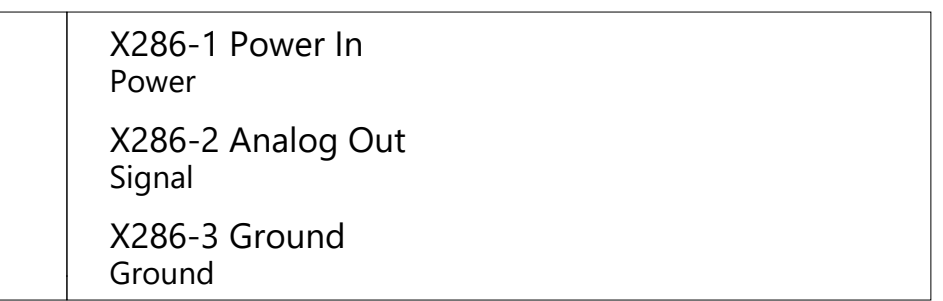

Body Controller Right
B,P,J,W

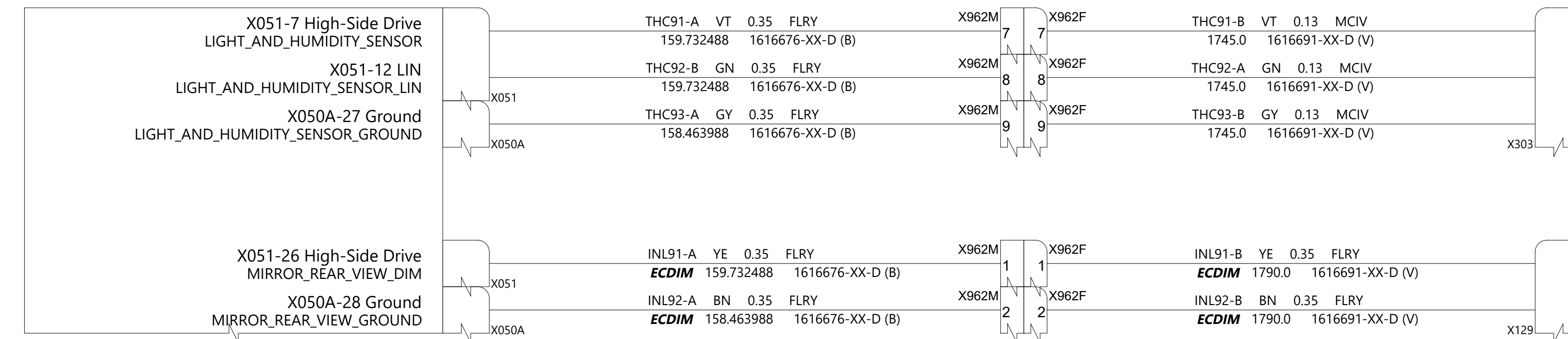

Humidity and Glass Temp
V

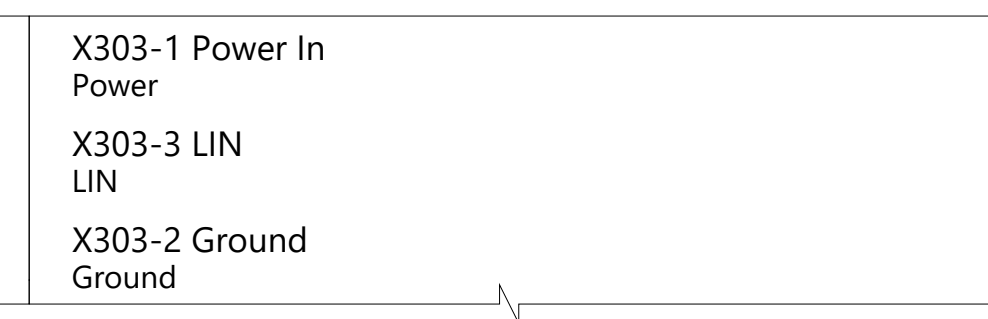

ECDIM
Mirror - Rear View - Electrochromic
V



DRAWN				CHECKED		APPROVED	
MATERIAL AS SPECIFIED		FINISHING AS SPECIFIED		SCALE NONE			
PART NAME Headliner							
PART NUMBER		REV 1	SHEET 24 of 54	SIZE A0			

Body Controller Left
A,D,J,W X036 X030A X030B X031 X039 X037 X033A X033B X032 X035 X038

Body Controller Right
B,P,J,W X056 X050A X050B X051 X059 X057 X053A X053B X052 X055 X058 X060

HV Battery
B X098 X006 X007

X098-18 Power In
VEH-12V-CONTACTOR-POWER
X098-13 Digital In
RCM-ENS-IN

X098-8 Power In
VEH-12V-BAT
X098-12 High-Side Drive
DCDC-Enable

X098-16 CAN
VEHICLE-CAN-H
X098-15 CAN
VEHICLE-CAN-L

X098-7 CAN
CP-CAN-H
X098-6 CAN
CP-CAN-L

X098-11 Digital Out
CP-LATCH-EN
X098-10 Digital In
CP-FAULT

X098-1 Analog Out
VEH-HVIL-OUT
X098-3 Analog In
VEH-HVIL-IN

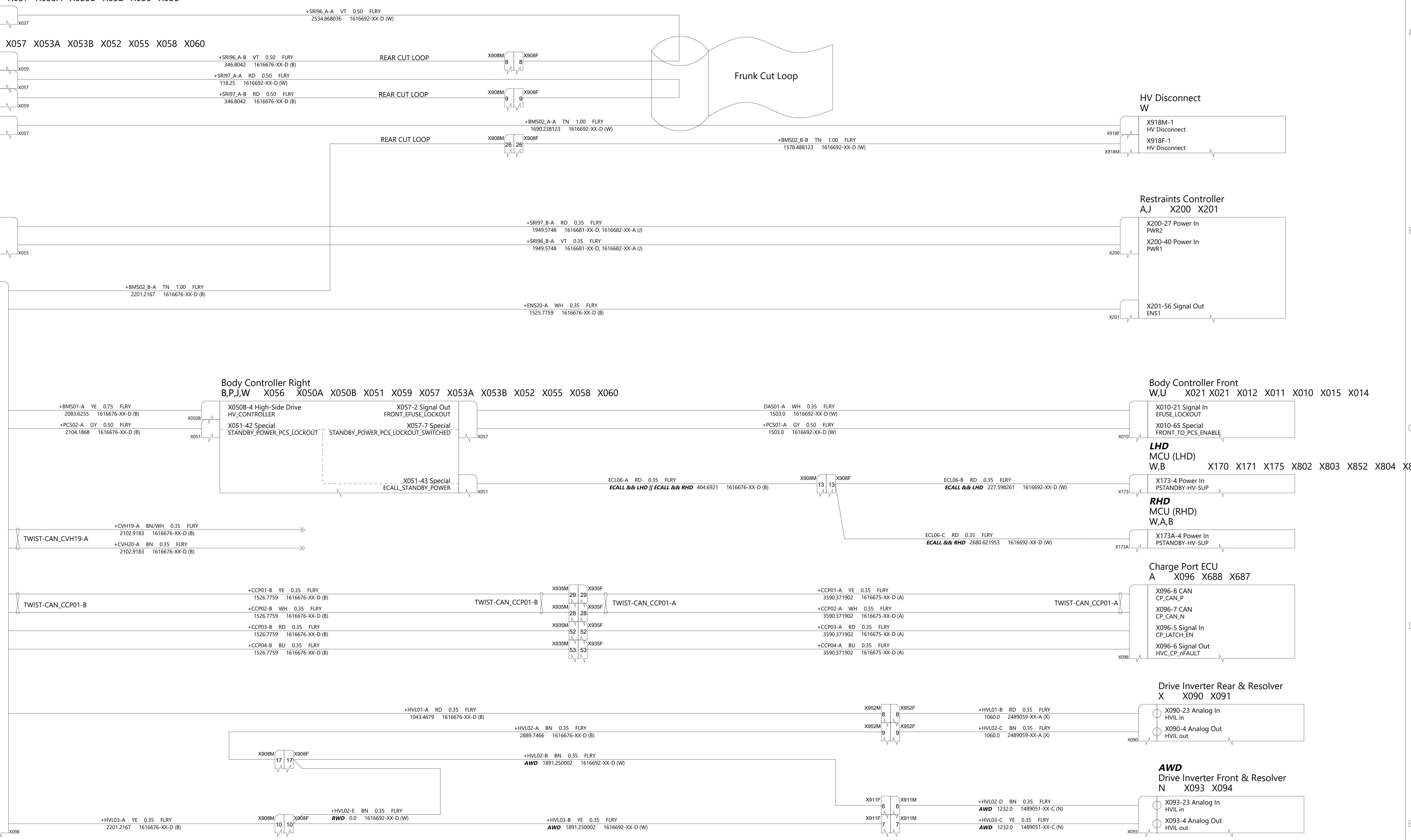

THE INFORMATION CONTAINED HEREIN IS DEEMED TO BE CONFIDENTIAL, PROPRIETARY, AND A TRADE SECRET OF TESLA MOTORS. THIS INFORMATION MAY NOT BE USED, REPRODUCED, OR DISCLOSED AS THE DIRECT OR INDIRECT BASIS FOR THE DEVELOPMENT, MANUFACTURE, OR SALE OF PROCESSES OR PRODUCTS WITHOUT THE EXPRESSED WRITTEN CONSENT OF TESLA MOTORS.

DRAWN	CHECKED	APPROVED
-------	---------	----------

MATERIAL AS SPECIFIED	FINISHING AS SPECIFIED	SCALE NONE
--------------------------	---------------------------	---------------

PART NAME
HV Battery and HVIL

PART NUMBER	REV	SHEET	SIZE
	1	25 of 54	A0

Heatpump HV Inductor
H

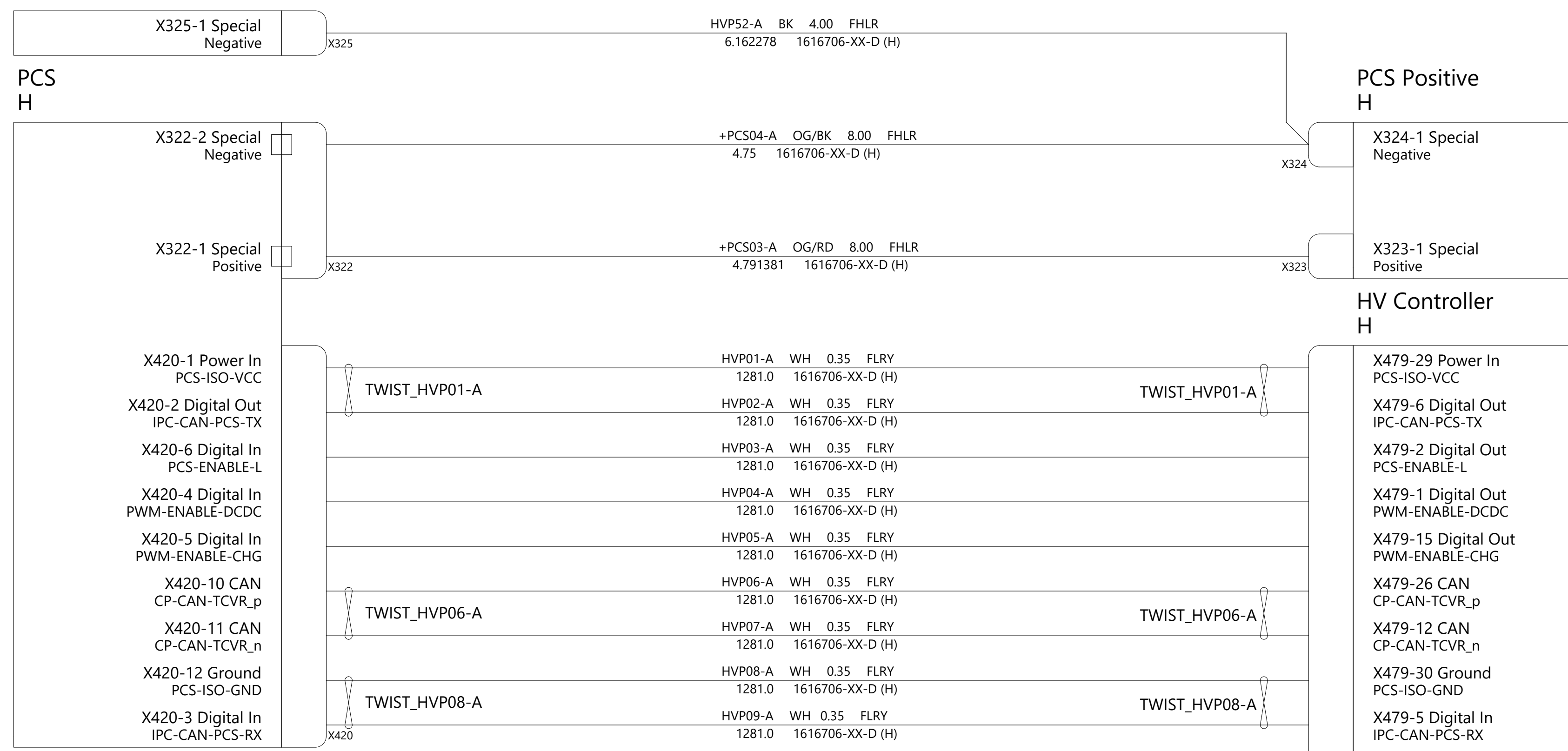

PCS Positive
H

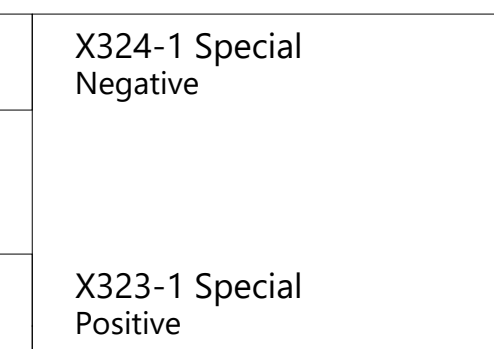

HV Controller
H

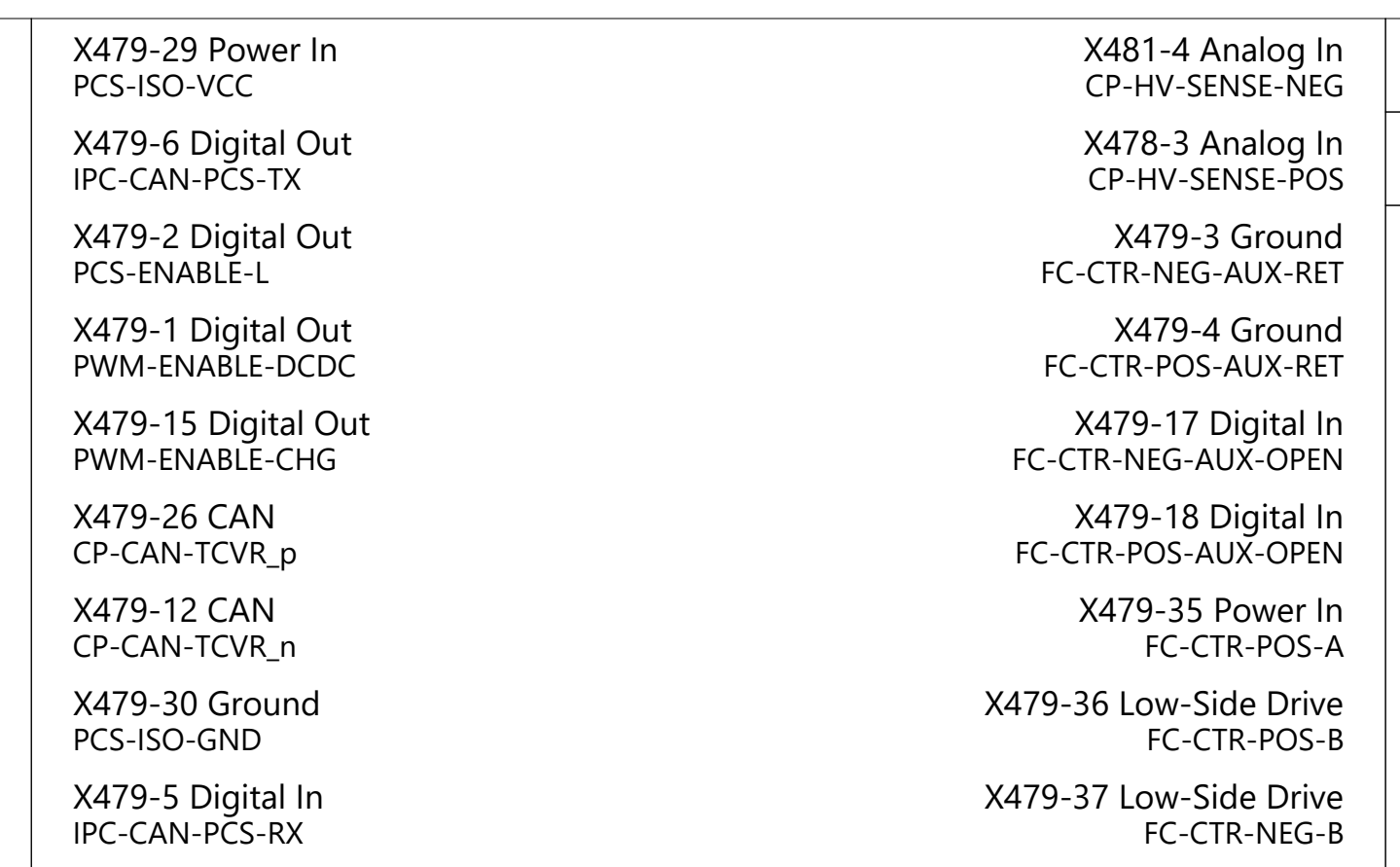

FAS-CHR-CONTACT-P1
H

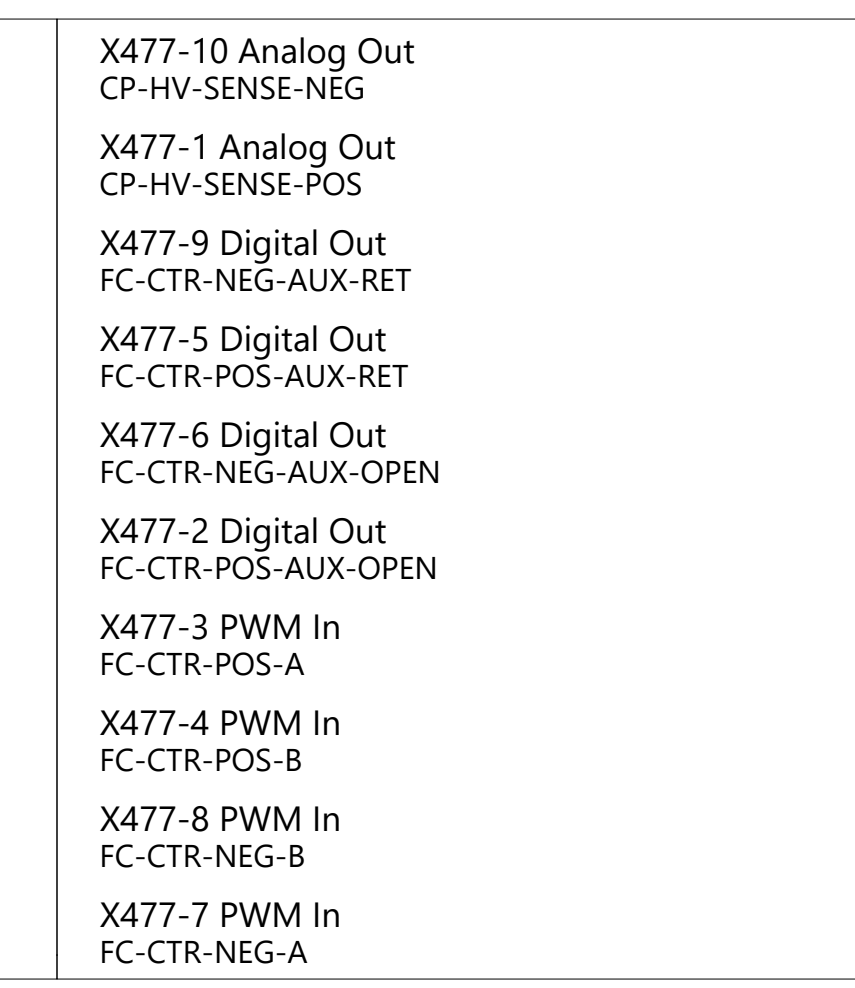

AWD
HV-FDU
H

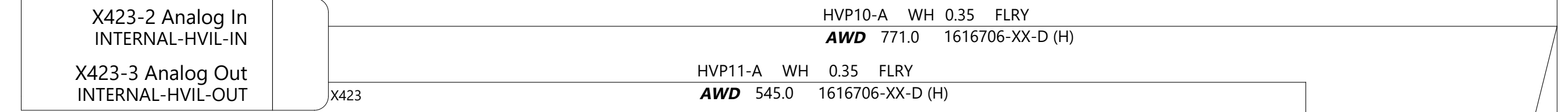

HV-RDU
H

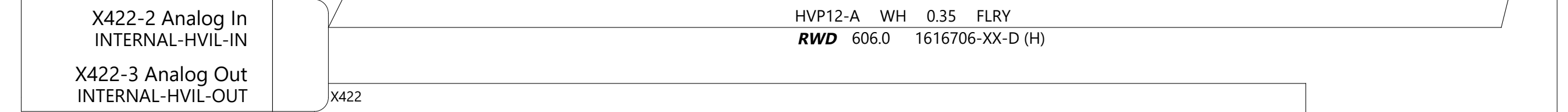

HV-ANCIL
H

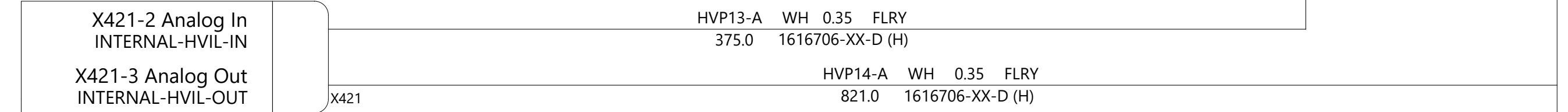

CHARGER-INLET
H

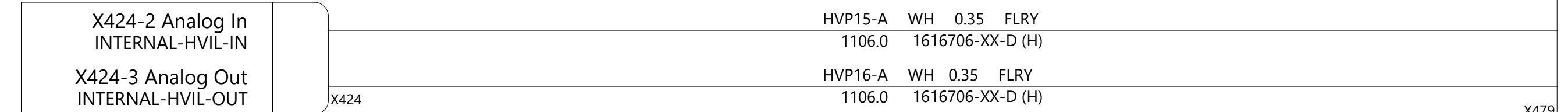

BMB-DAISY-A
H

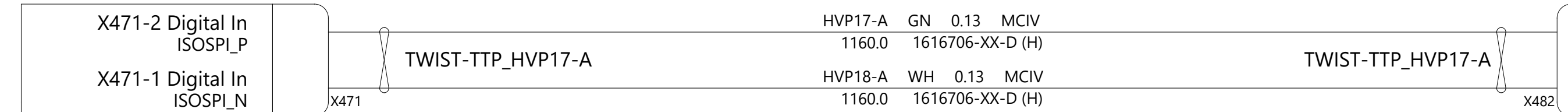

BMB-DAISY-B
H

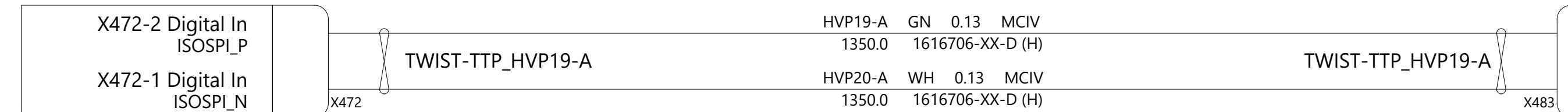

X479-24 Analog Out
INTERNAL-HVIL-OUT

X479-7 Analog In
INTERNAL-HVIL-IN

X479-10 Analog Out
CP-HV-CABLES-OK-OUT

X479-16 Analog In
CP-HV-CABLES-OK-IN

X482-1 Analog Out
BMB-DIR-A p

X482-2 Analog Out
BMB-DIR-A n

X483-1 Analog Out
BMB-PRI-DIR-8 p

X483-2 Analog Out
BMB-PRI-DIR-8 n

POS-SWITCH
H

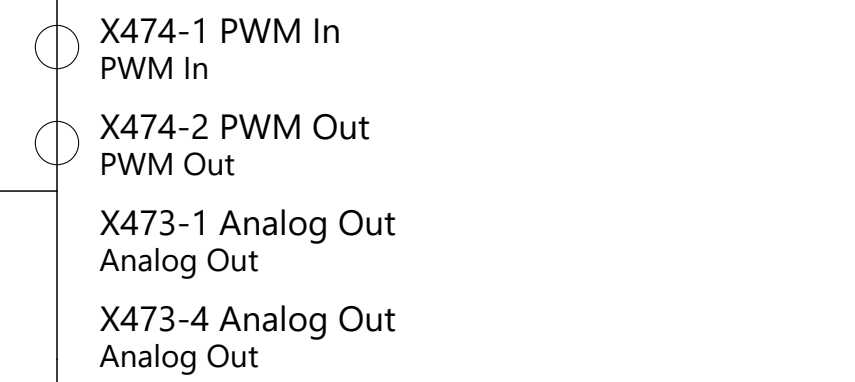

NEG-SWITCH
H

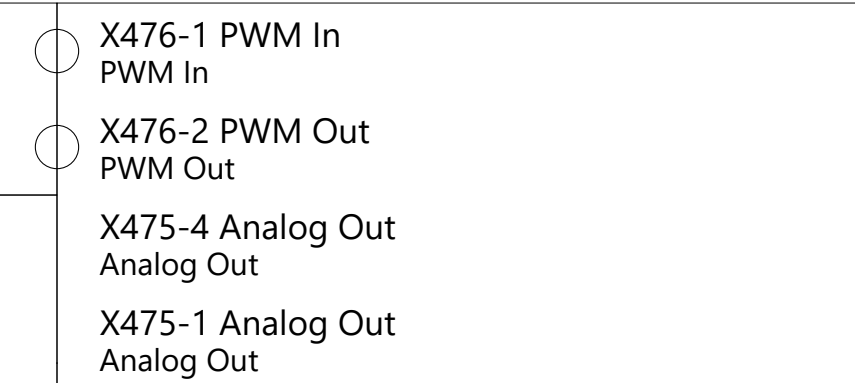

SHUNT-P1
H

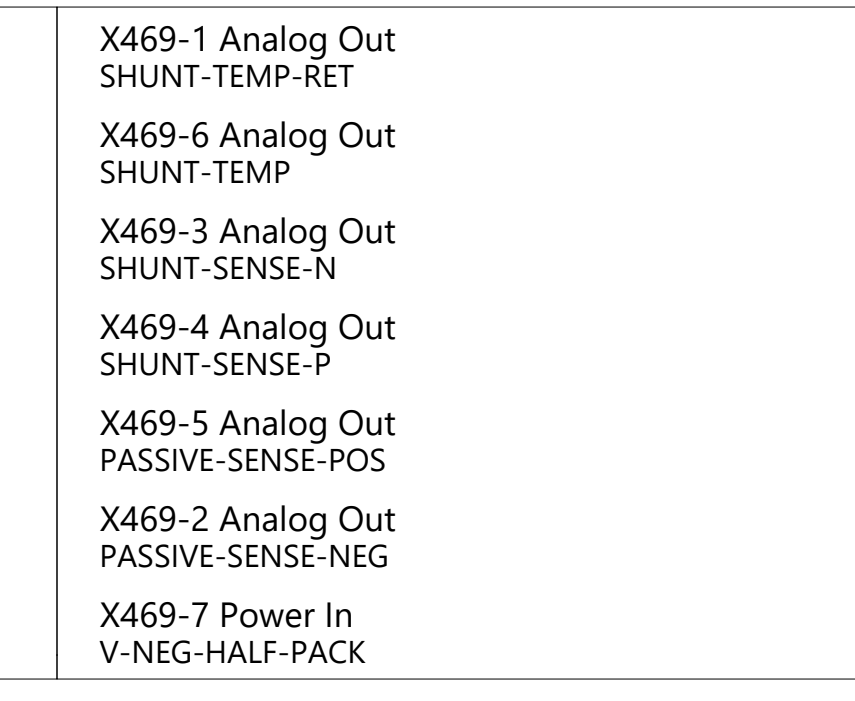

PYRO-DISC-P1
H



THE INFORMATION CONTAINED HEREIN IS DEEMED TO BE CONFIDENTIAL, PROPRIETARY, AND A TRADE SECRET OF TESLA MOTORS. THIS INFORMATION MAY NOT BE USED, REPRODUCED, OR DISCLOSED AS THE DIRECT OR INDIRECT BASIS FOR THE DEVELOPMENT, MANUFACTURE, OR SALE OF PROCESSES OR PRODUCTS WITHOUT THE EXPRESSED WRITTEN CONSENT OF TESLA MOTORS.

DRAWN	CHECKED	APPROVED
MATERIAL AS SPECIFIED	FINISHING AS SPECIFIED	SCALE NONE
PART NAME HV Penthouse		
PART NUMBER	REV 1	SHEET 26 of 54
		SIZE A0

Body Controller Front
W,U X021 X012 X011 X010 X015 X014

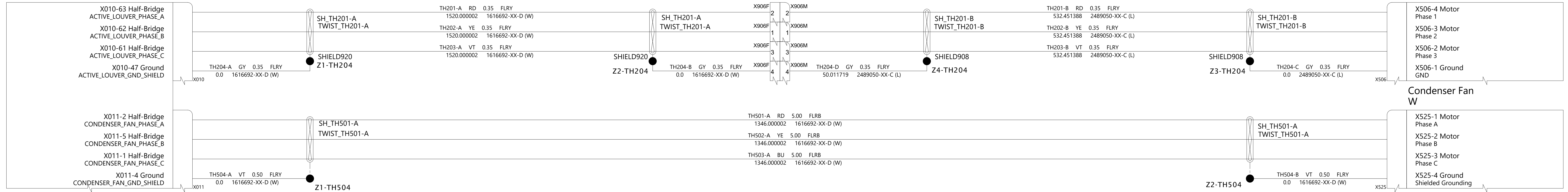

Body Controller Right
B,P,J,W X056 X050A X050B X059 X057 X053A X053B X052 X055 X058 X060

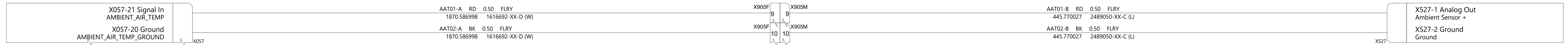

THE INFORMATION CONTAINED HEREIN IS DEEMED TO BE CONFIDENTIAL, PROPRIETARY, AND A TRADE SECRET OF TESLA MOTORS. THIS INFORMATION MAY NOT BE USED, REPRODUCED, OR DISCLOSED AS THE DIRECT OR INDIRECT BASIS FOR THE DEVELOPMENT, MANUFACTURE, OR SALE OF PROCESSES OR PRODUCTS WITHOUT THE EXPRESSED WRITTEN CONSENT OF TESLA MOTORS.

DRAWN	CHECKED	APPROVED
-------	---------	----------

MATERIAL AS SPECIFIED	FINISHING AS SPECIFIED	SCALE NONE
--------------------------	---------------------------	---------------

PART NAME
HVAC - Powertrain

PART NUMBER	REV	SHEET	SIZE
	1	27 of 54	A0

Body Controller Right
B,P,J,W X056 X050A X050B X051 X059 X057 X053A X053B X052 X055 X058 X060

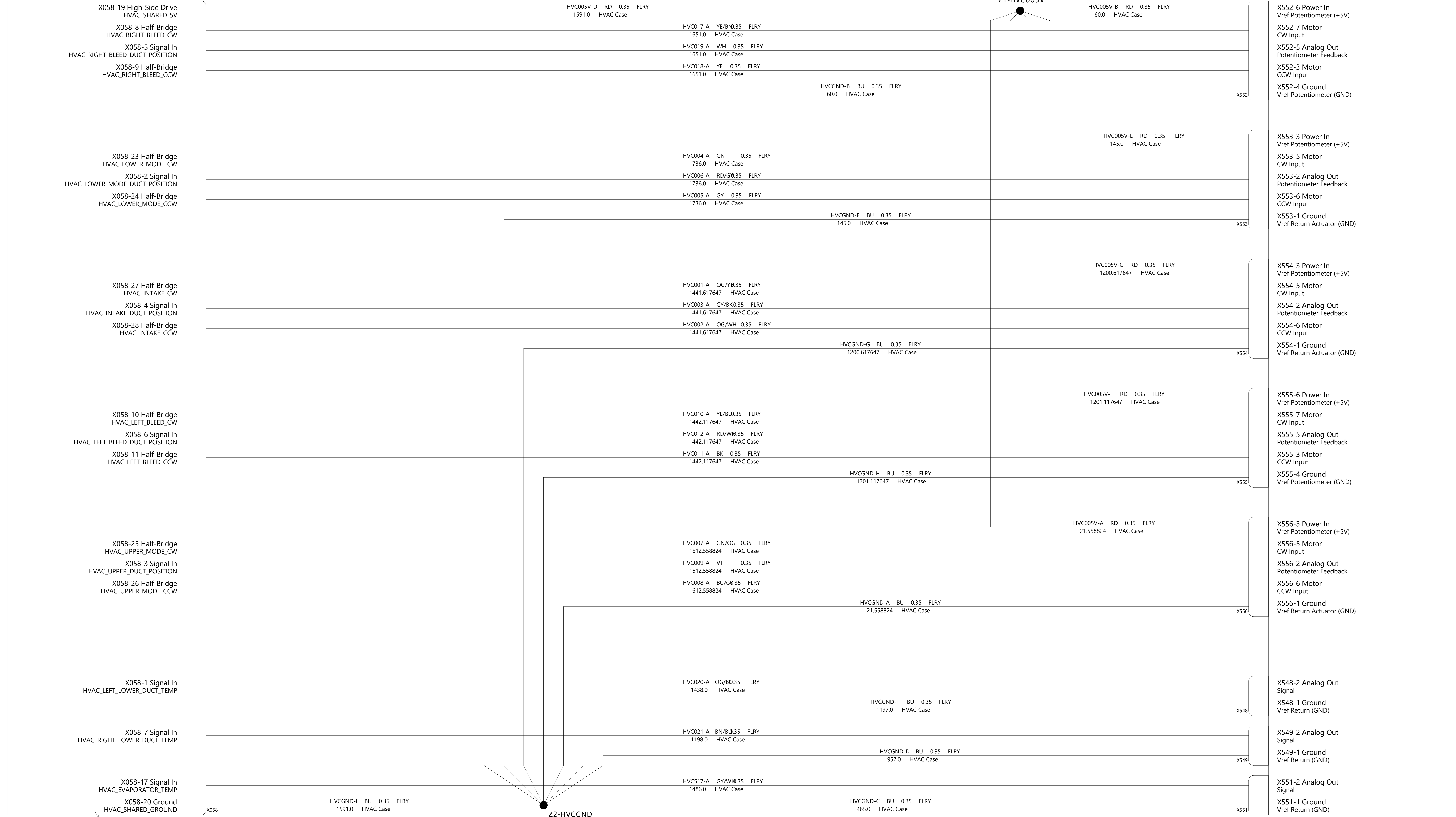

HVAC CASE
HVAC CASE

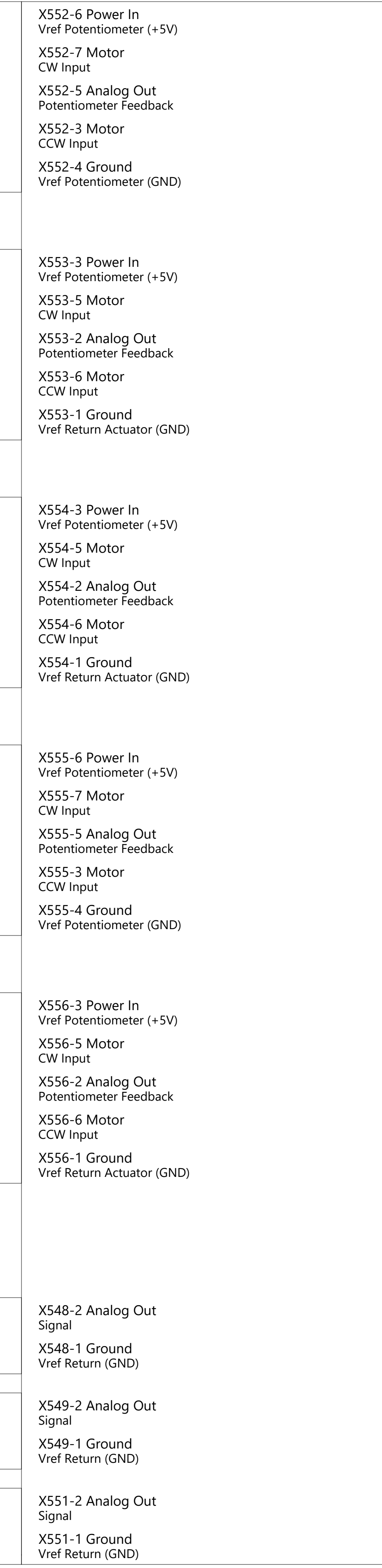

Body Controller Left
A,D,J,W X036 X030A X030B X031 X039 X037 X033A X033B X032 X035 X038

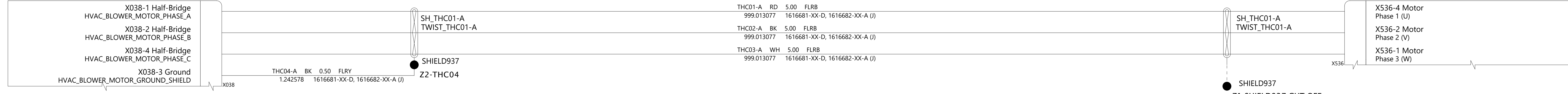

Blower Motor
J

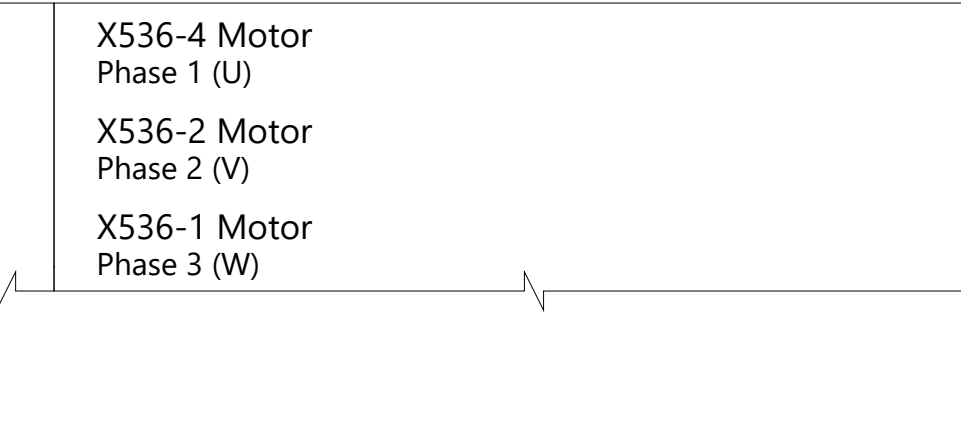

THE INFORMATION CONTAINED HEREIN IS DEEMED TO BE CONFIDENTIAL, PROPRIETARY, AND A TRADE SECRET OF TESLA MOTORS. THIS INFORMATION MAY NOT BE USED, REPRODUCED, OR DISCLOSED AS THE OBJECT OR INDIRECT BASIS FOR THE DEVELOPMENT, MANUFACTURE, OR SALE OF PROCESSES OR PRODUCTS WITHOUT THE EXPRESSED WRITTEN CONSENT OF TESLA MOTORS.

DRAWN	CHECKED	APPROVED
MATERIAL AS SPECIFIED	FINISHING AS SPECIFIED	SCALE NONE
PART NAME HVAC Case		
PART NUMBER	REV 1	SHEET 28 of 54
		SIZE A0

Battery Coolant Pump UHP

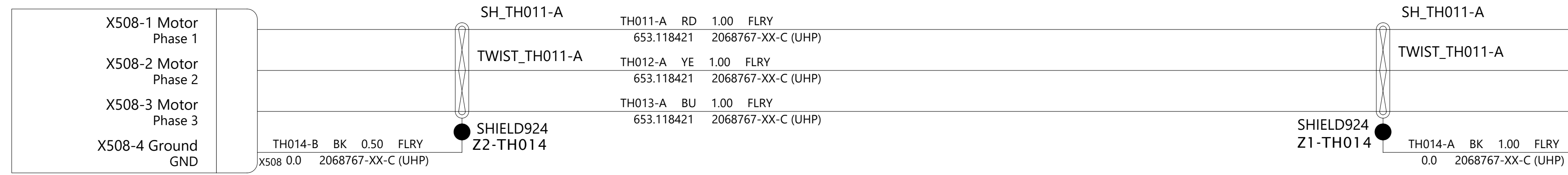

Powertrain Coolant Pump UHP

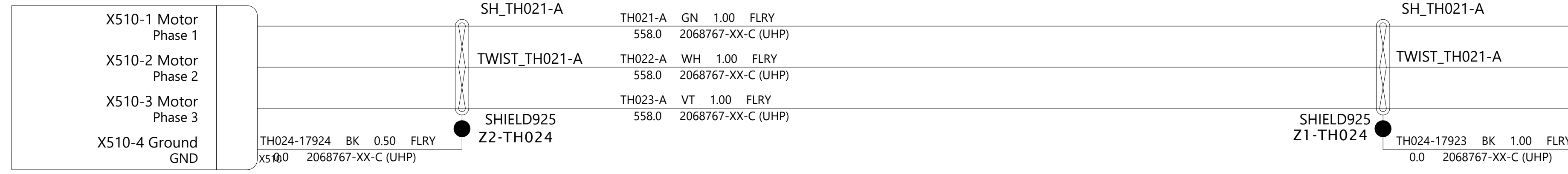

Coolant Temp Sensor - Battery

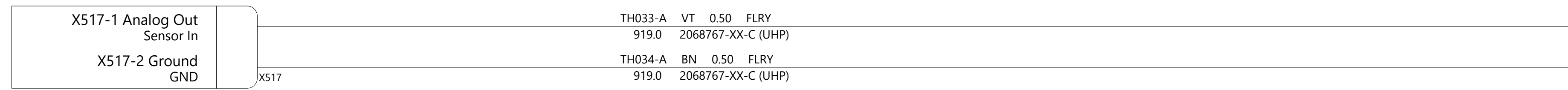

Coolant Temp Sensor - Powertrain

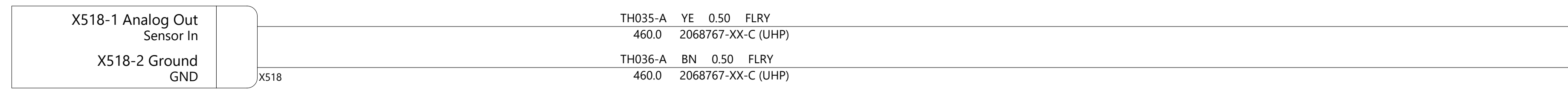

Coolant Level Sensor, Heat Pump UHP

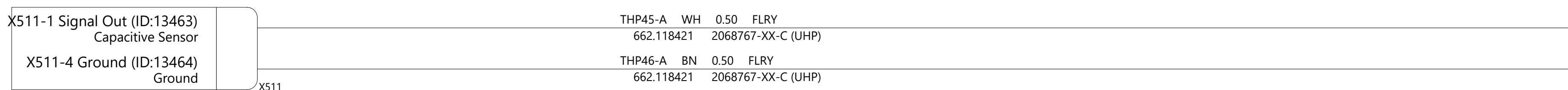

8 Way Coolant Valve UHP

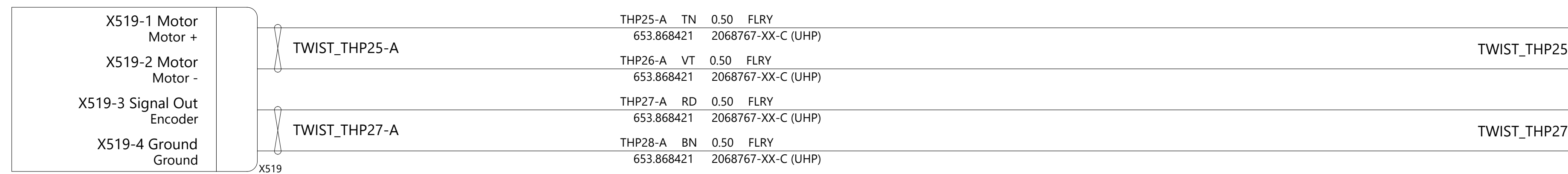

HV Compressor UHP,W

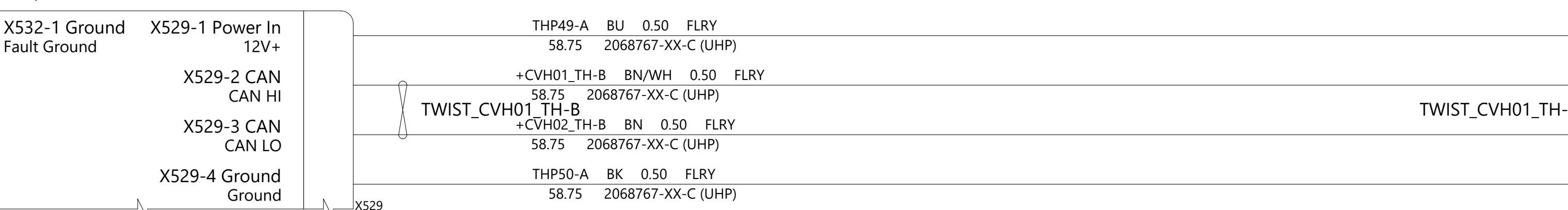

Body Controller Front W,U

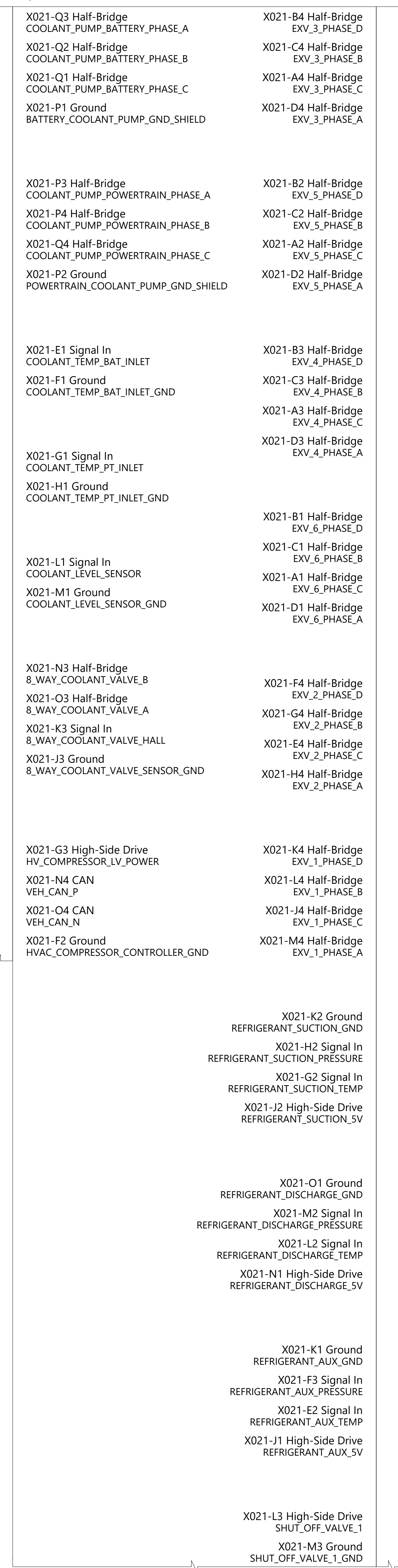

EXV, Recirc UHP

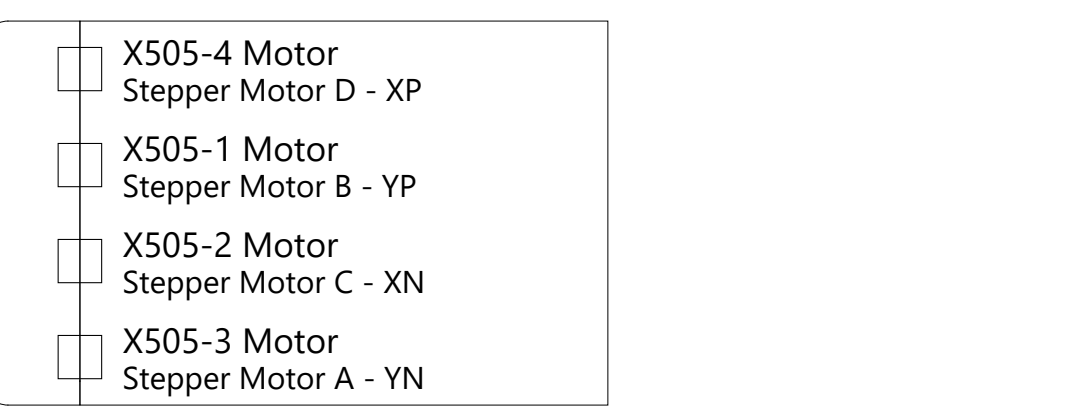

EXV, Cabin Condenser Left UHP

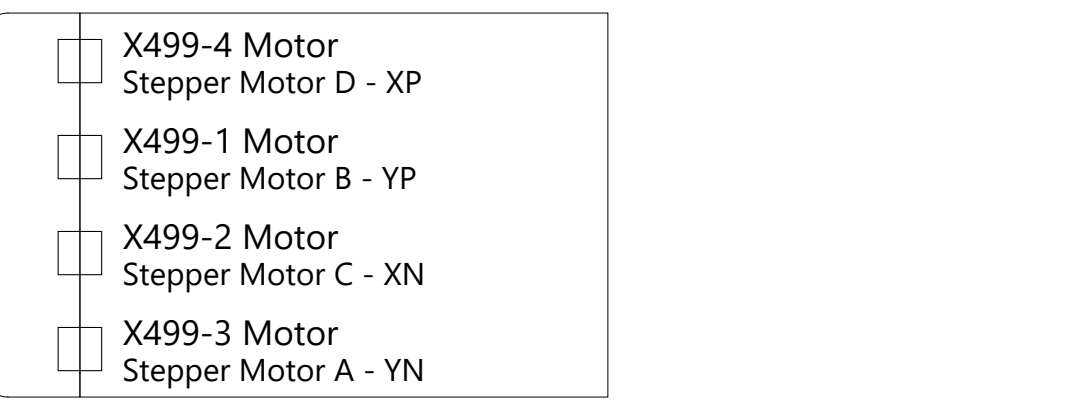

EXV, Liquid Cooled Condenser UHP

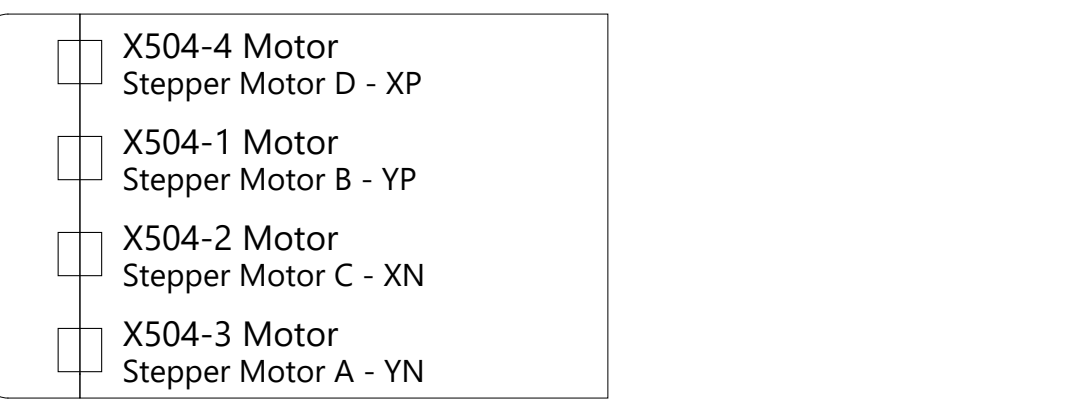

EXV, Cabin Condenser Right UHP

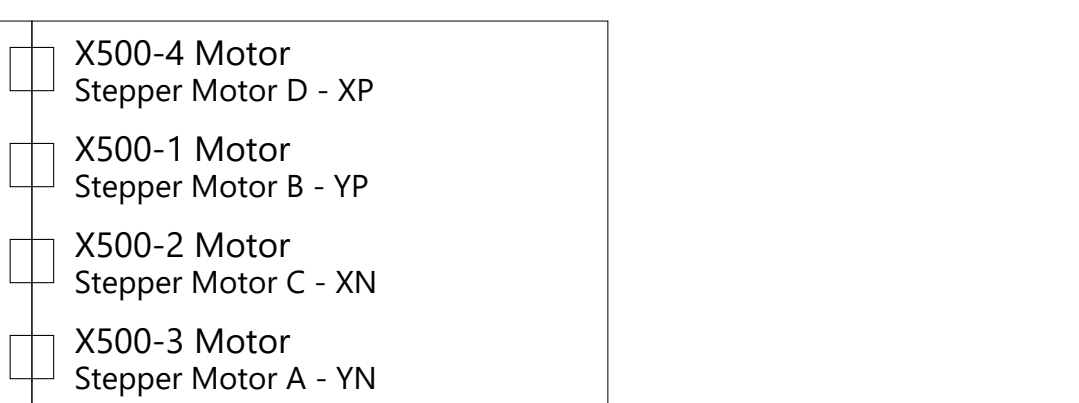

EXV, Evaporator UHP

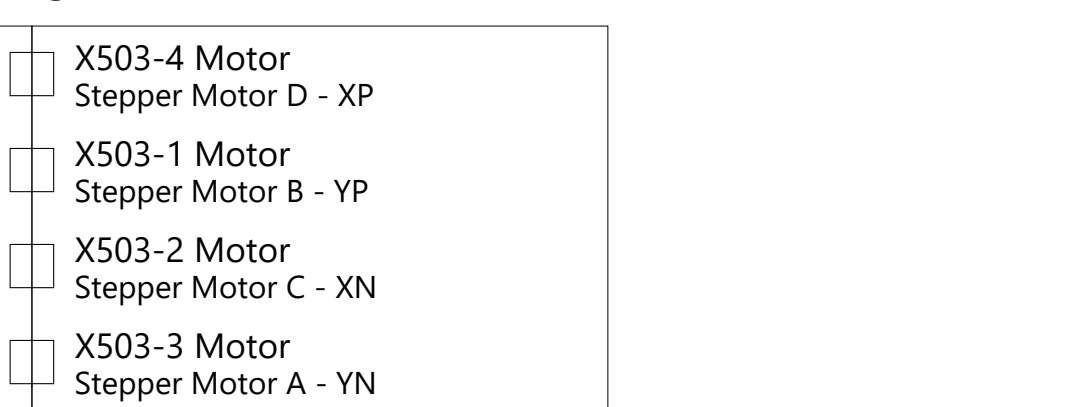

EXV, Chiller UHP

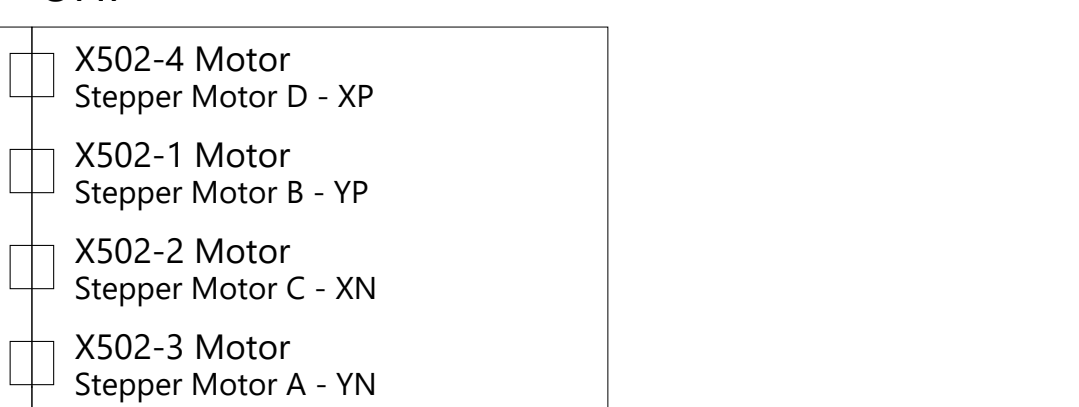

Refrigerant Temp and Pressure Sensor, Suction UHP

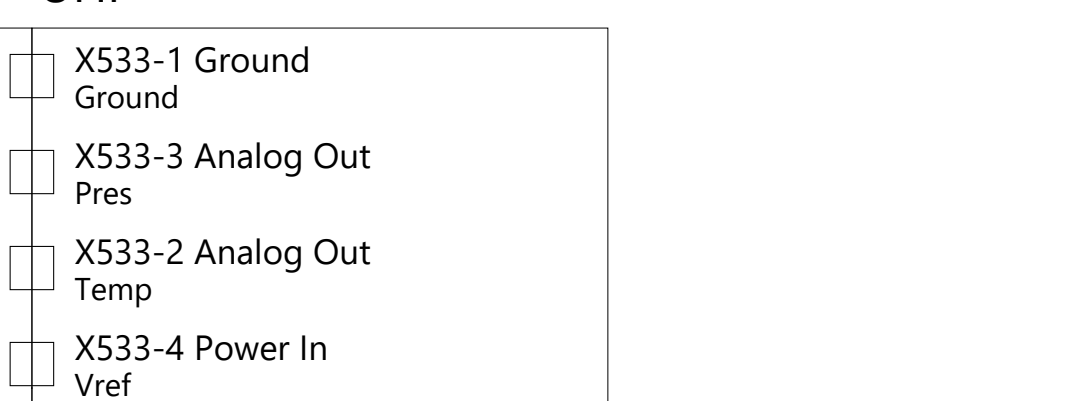

Refrigerant Temp and Pressure Sensor, Discharge UHP

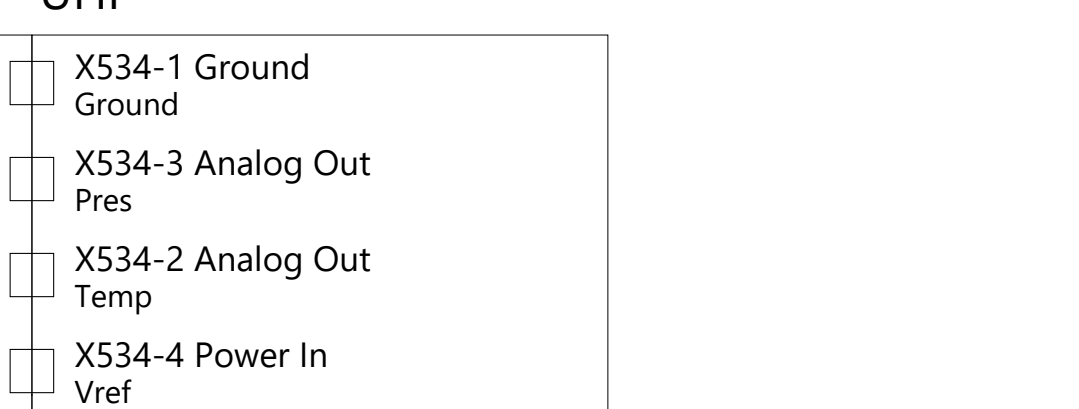

Refrigerant Temp and Pressure Sensor, Subcool UHP

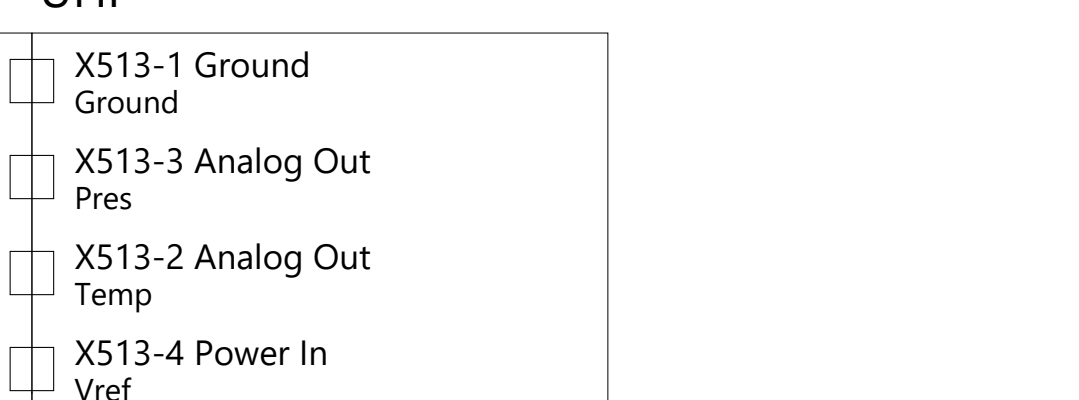

Refrigerant Evap SOV UHP



THE INFORMATION CONTAINED HEREIN IS DEEMED TO BE CONFIDENTIAL, PROPRIETARY, AND A TRADE SECRET OF TESLA MOTORS. THIS INFORMATION MAY NOT BE USED, REPRODUCED, OR DISCLOSED AS THE DIRECT OR INDIRECT BASIS FOR THE DEVELOPMENT, MANUFACTURE, OR SALE OF PROCESSES OR PRODUCTS WITHOUT THE EXPRESSED WRITTEN CONSENT OF TESLA MOTORS.

DRAWN	CHECKED	APPROVED
MATERIAL AS SPECIFIED	FINISHING AS SPECIFIED	SCALE NONE
PART NAME HVAC Heat Pump		
PART NUMBER	REV	SHEET
	1	29 OF 54
		A0

Body Controller Left
A,D,J,W X036 X030A X030B X031 X039 X037 X033A X033B X032 X035 X038

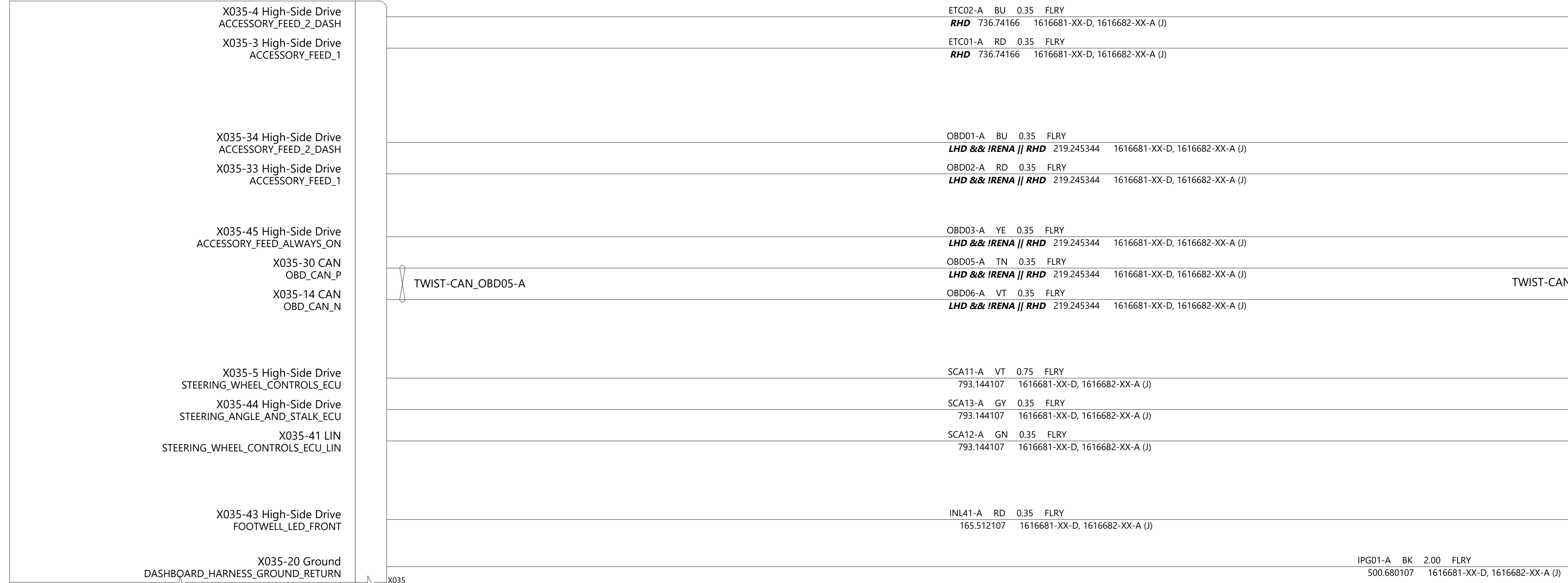

Body Controller Right
B,P,J,W X056 X050A X050B X051 X059 X057 X053A X053B X052 X055 X058 X060

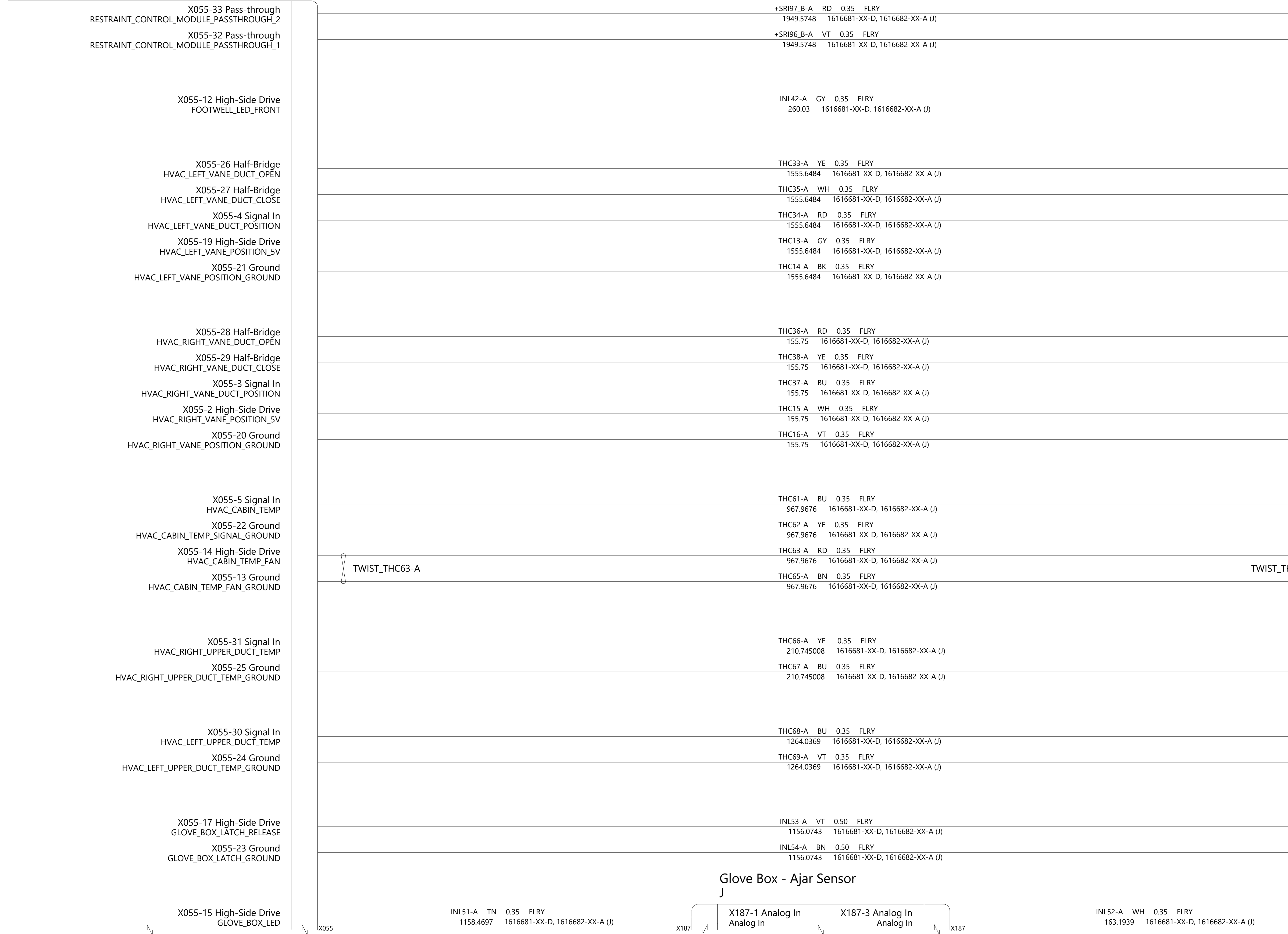

RHD ETC
J



OBD-II
J

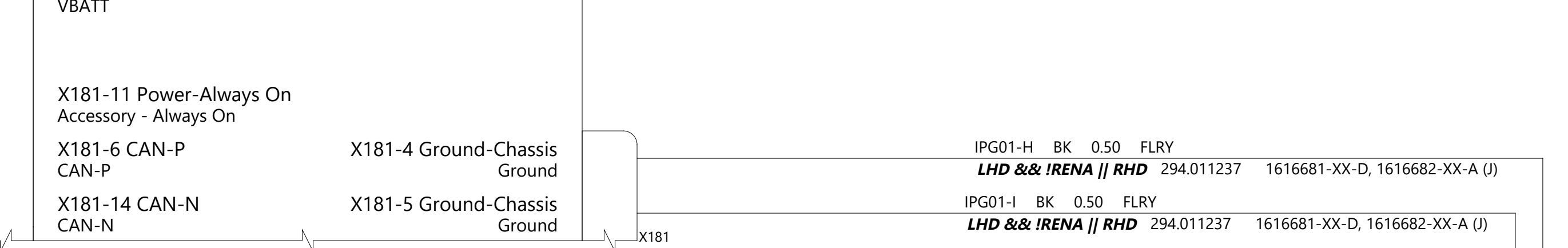

Steering Angle and Stalk ECU
J

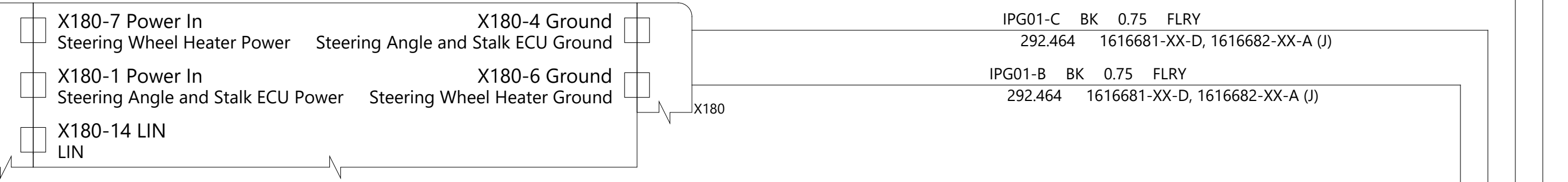

Footwell LED Front Left
J

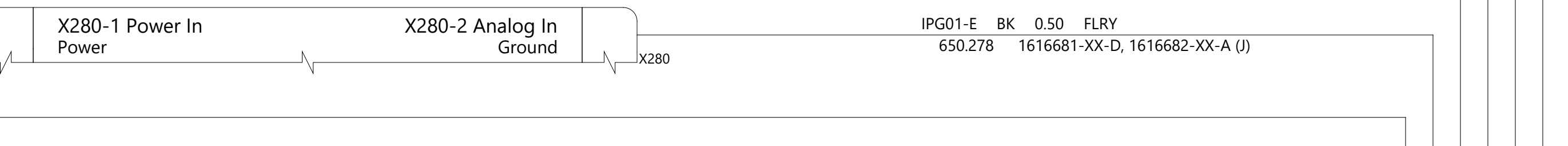

Restraints Controller
A,J X200 X201

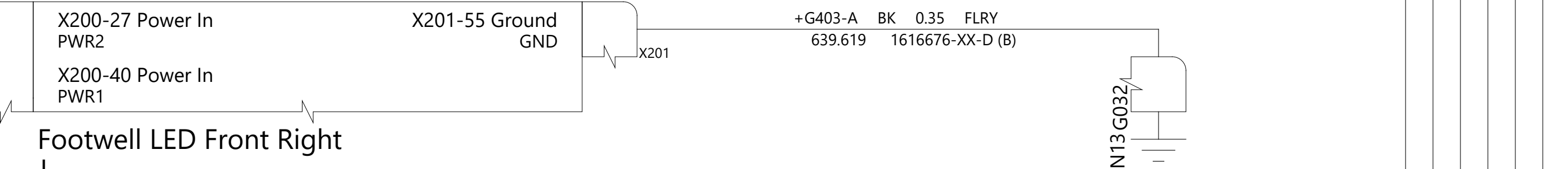

Footwell LED Front Right
J



Lateral Vanes Left
J

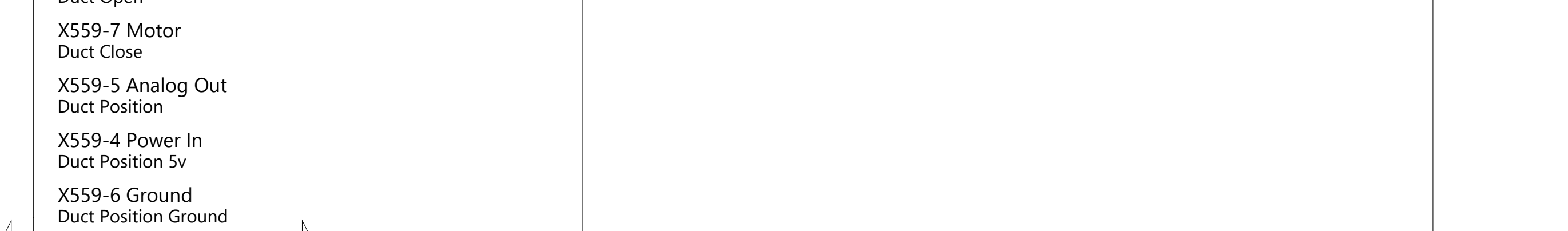

Lateral Vanes Right
J



Cabin Thermistors
J



IP Duct Thermistor, Right
J



IP Duct Thermistor, Left
J



Glove Box - Latch
J



Glove Box - LED
J



Glove Box - Ajar Sensor
J

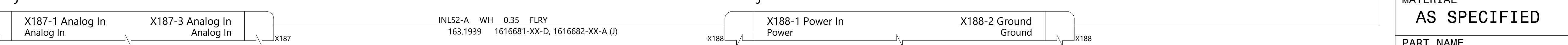

THE INFORMATION CONTAINED HEREIN IS DEEMED TO BE CONFIDENTIAL, PROPRIETARY, AND A TRADE SECRET OF TESLA MOTORS. THIS INFORMATION MAY NOT BE USED, REPRODUCED, OR DISCLOSED AS THE DIRECT OR INDIRECT BASIS FOR THE DEVELOPMENT, MANUFACTURE, OR SALE OF PROCESSES OR PRODUCTS WITHOUT THE EXPRESSED WRITTEN CONSENT OF TESLA MOTORS.

DRAWN	CHECKED	APPROVED
MATERIAL AS SPECIFIED	FINISHING AS SPECIFIED	SCALE NONE
PART NAME Instrument Panel		
PART NUMBER	REV 1	SHEET 30 OF 54
		SIZE A0

Body Controller Left
A,D,J,W

X030A X030B X031 X039 X037 X033A X033B X032 X035 X038

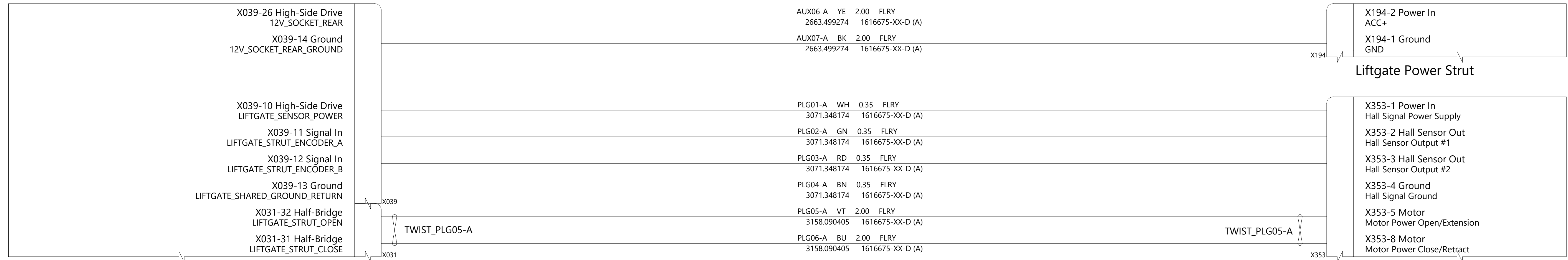

Body Controller Right
B,P,J,W

X056 X050A X050B X051 X059 X057 X053A X053B X052 X055 X058 X060

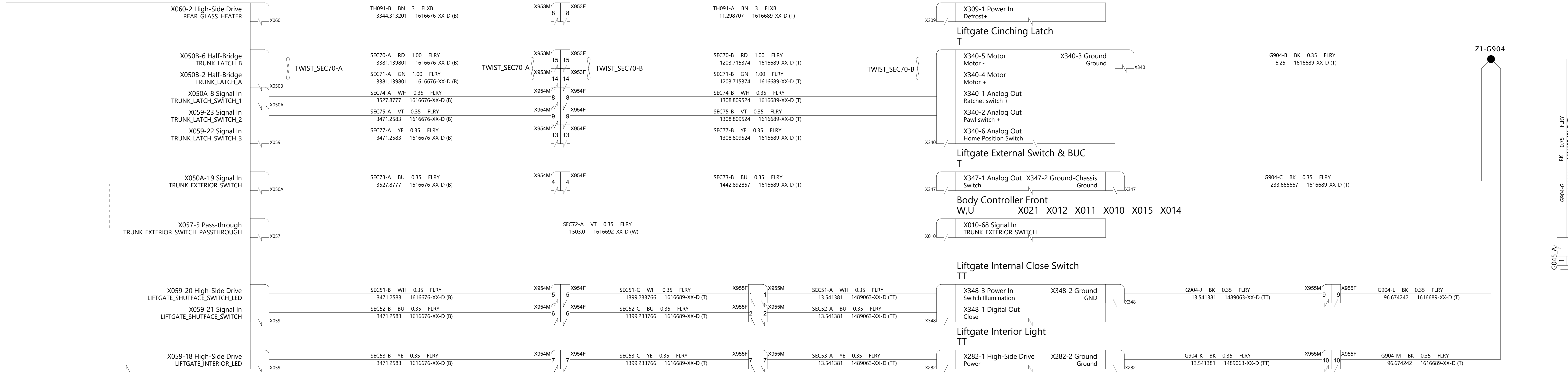

THE INFORMATION CONTAINED HEREIN IS DEEMED TO BE CONFIDENTIAL, PROPRIETARY, AND A TRADE SECRET OF TESLA MOTORS. THIS INFORMATION MAY NOT BE USED, REPRODUCED, OR DISCLOSED AS THE DIRECT OR INDIRECT BASIS FOR THE DEVELOPMENT, MANUFACTURE, OR SALE OF PROCESSES OR PRODUCTS WITHOUT THE EXPRESSED WRITTEN CONSENT OF TESLA MOTORS.

DRAWN	CHECKED	APPROVED
MATERIAL AS SPECIFIED	FINISHING AS SPECIFIED	SCALE NONE
PART NAME Liftgate and Trunk		
PART NUMBER	REV 1	SHEET 31 OF 54
		SIZE A0

Body Controller Front
W,U

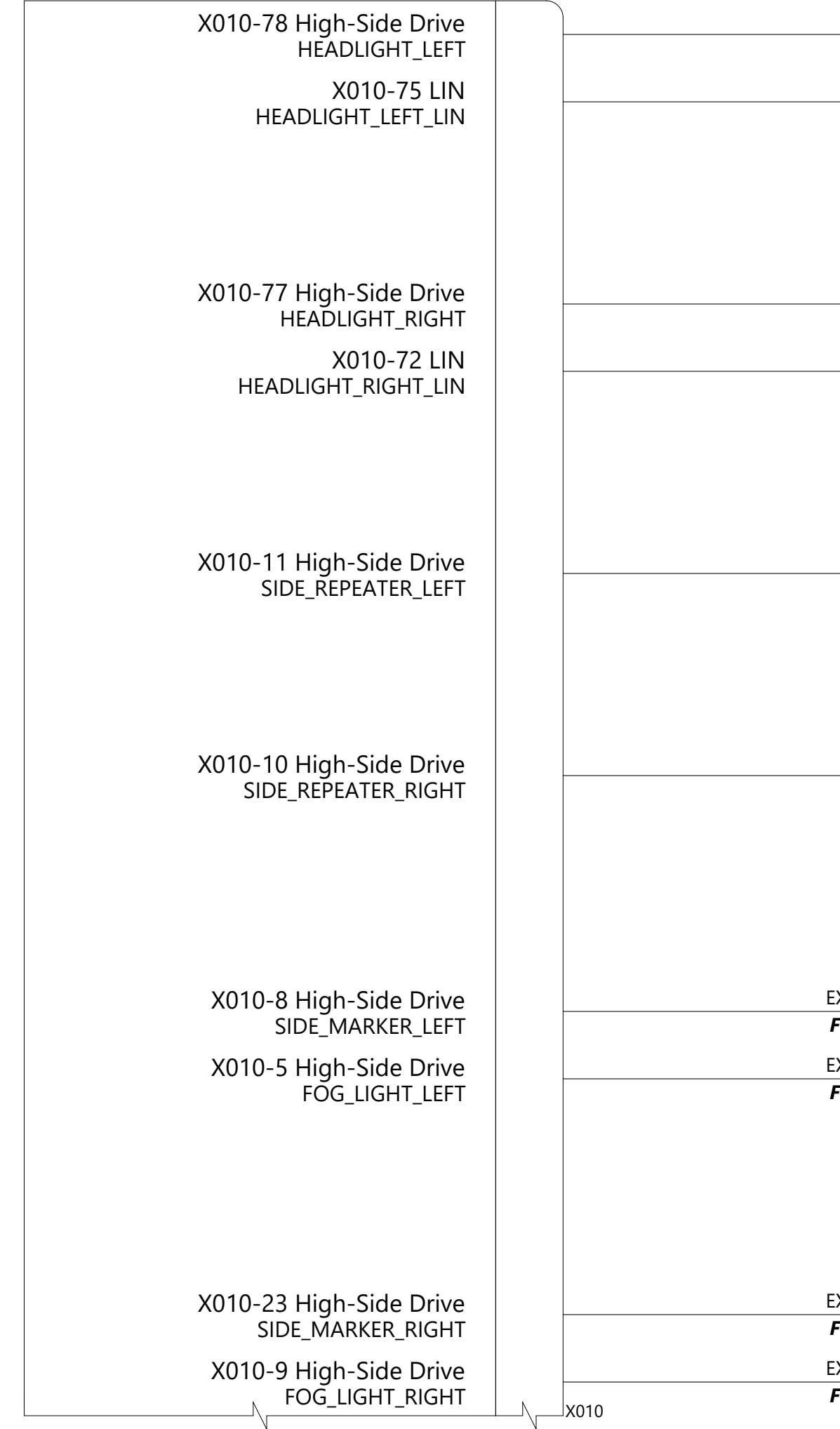

Headlamp Left
W

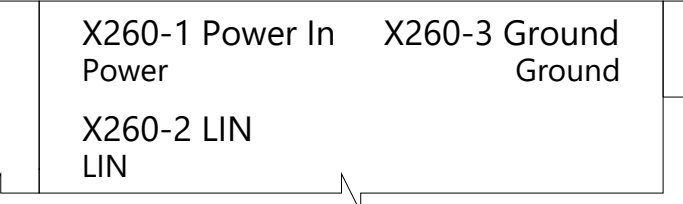

Headlamp Right
W

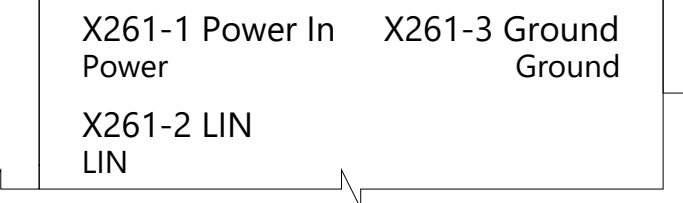

Side Repeater DAS Left
W

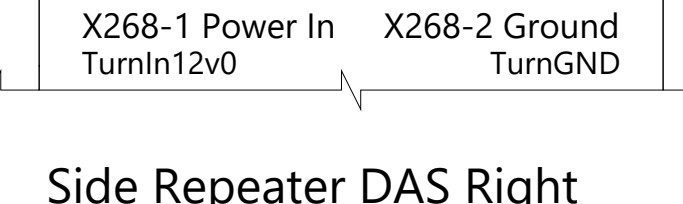

Side Repeater DAS Right
W

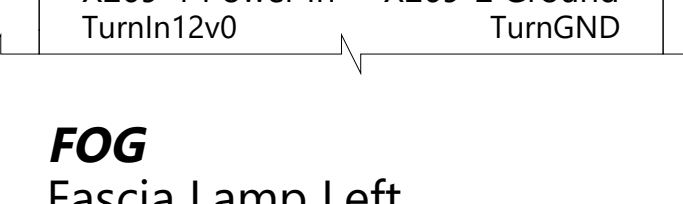

FOG Fascia Lamp Left
F

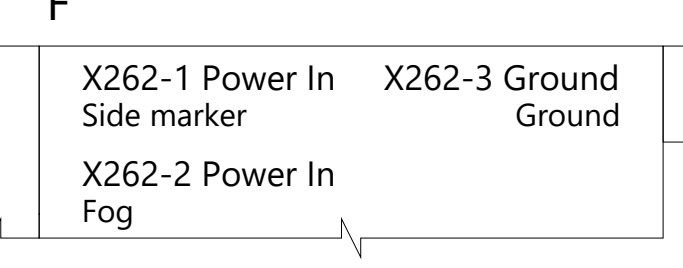

FOG Fascia Lamp Right
F

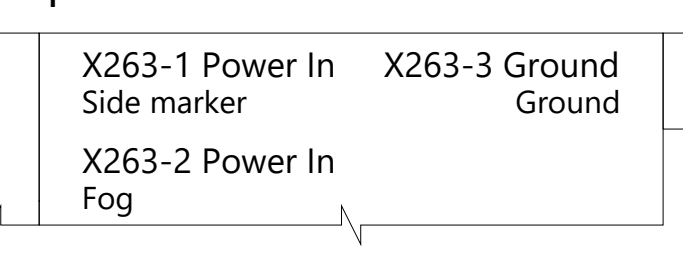

Body Controller Left
A,D,J,W

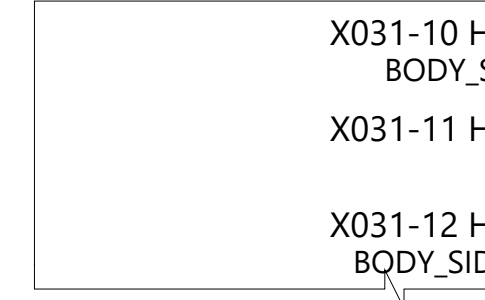

Tail Light Body LH
A

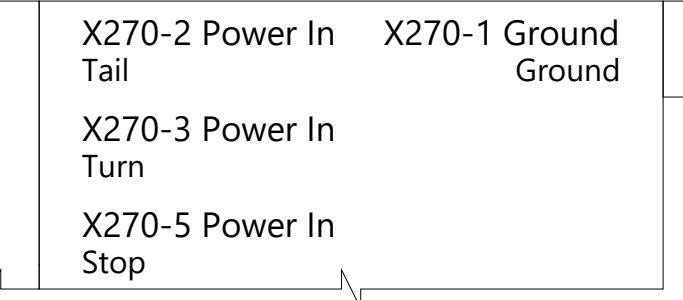

Body Controller Right
B,P,J,W

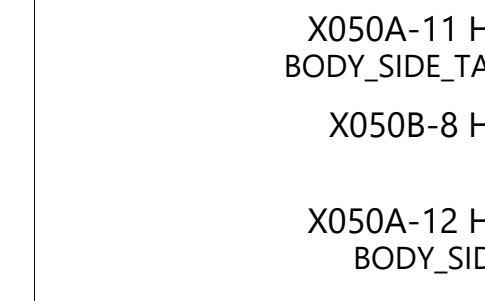

Tail Light Body RH
B

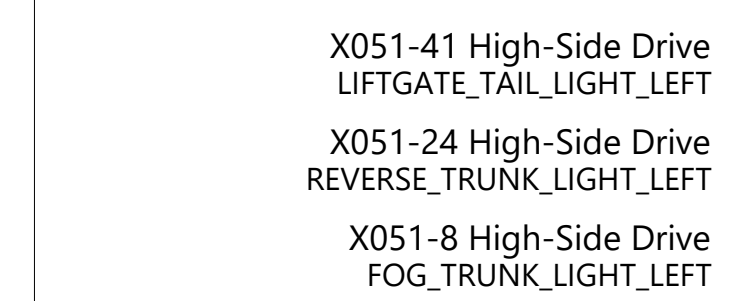
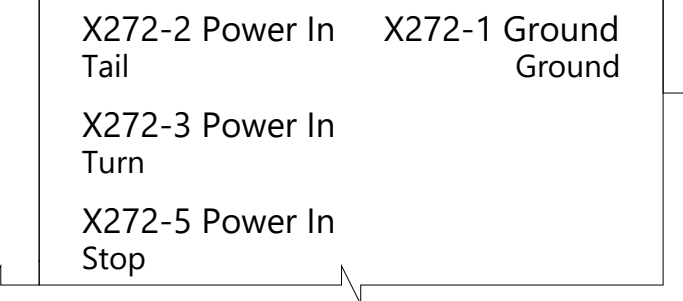

Tail Light Liftgate LH, Global
T

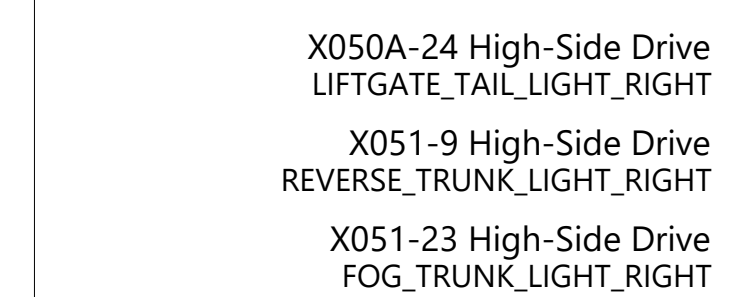
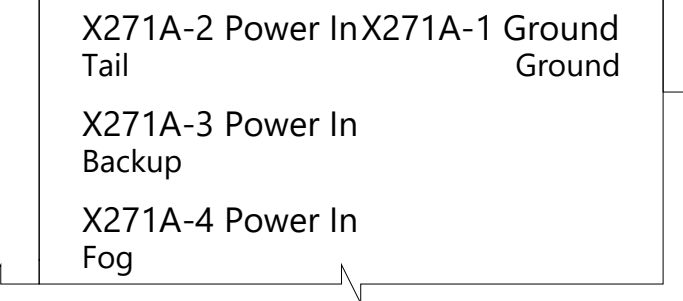

Tail Light Liftgate RH, Global
T

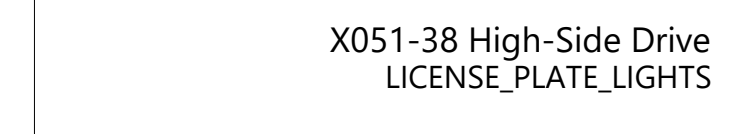
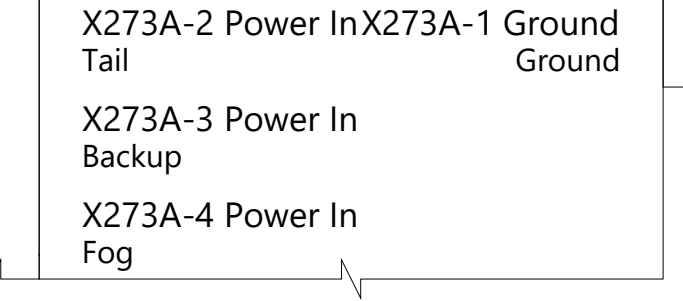

License Plate Lamp Left
T

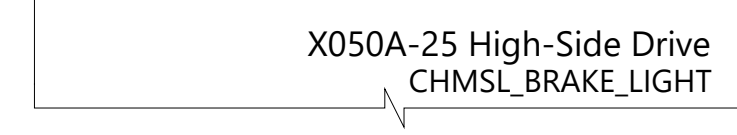
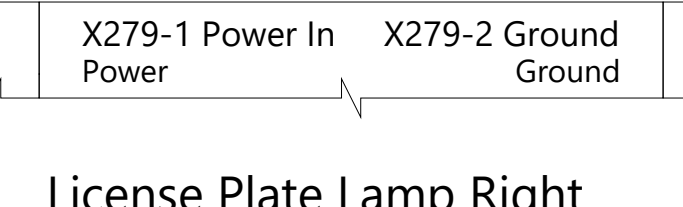

License Plate Lamp Right
T

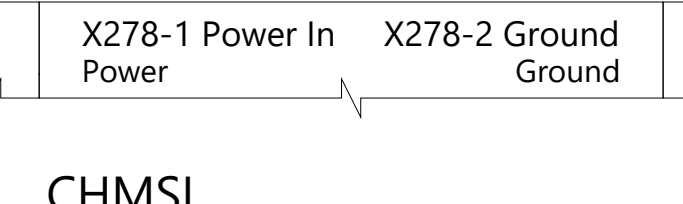

CHMSL
T

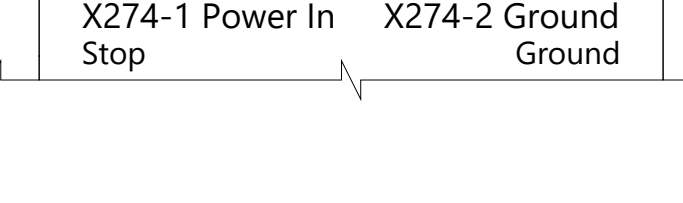

THE INFORMATION CONTAINED HEREIN IS DEEMED TO BE CONFIDENTIAL, PROPRIETARY, AND A TRADE SECRET OF TESLA MOTORS. THIS INFORMATION MAY NOT BE USED, REPRODUCED, OR DISCLOSED AS THE DIRECT OR INDIRECT BASIS FOR THE DEVELOPMENT, MANUFACTURE, OR SALE OF PROCESSES OR PRODUCTS WITHOUT THE EXPRESSED WRITTEN CONSENT OF TESLA MOTORS.

DRAWN	CHECKED	APPROVED
MATERIAL AS SPECIFIED	FINISHING AS SPECIFIED	SCALE NONE
PART NAME Lighting - Exterior		
PART NUMBER	REV	SHEET
	1	32 of 54
		A0

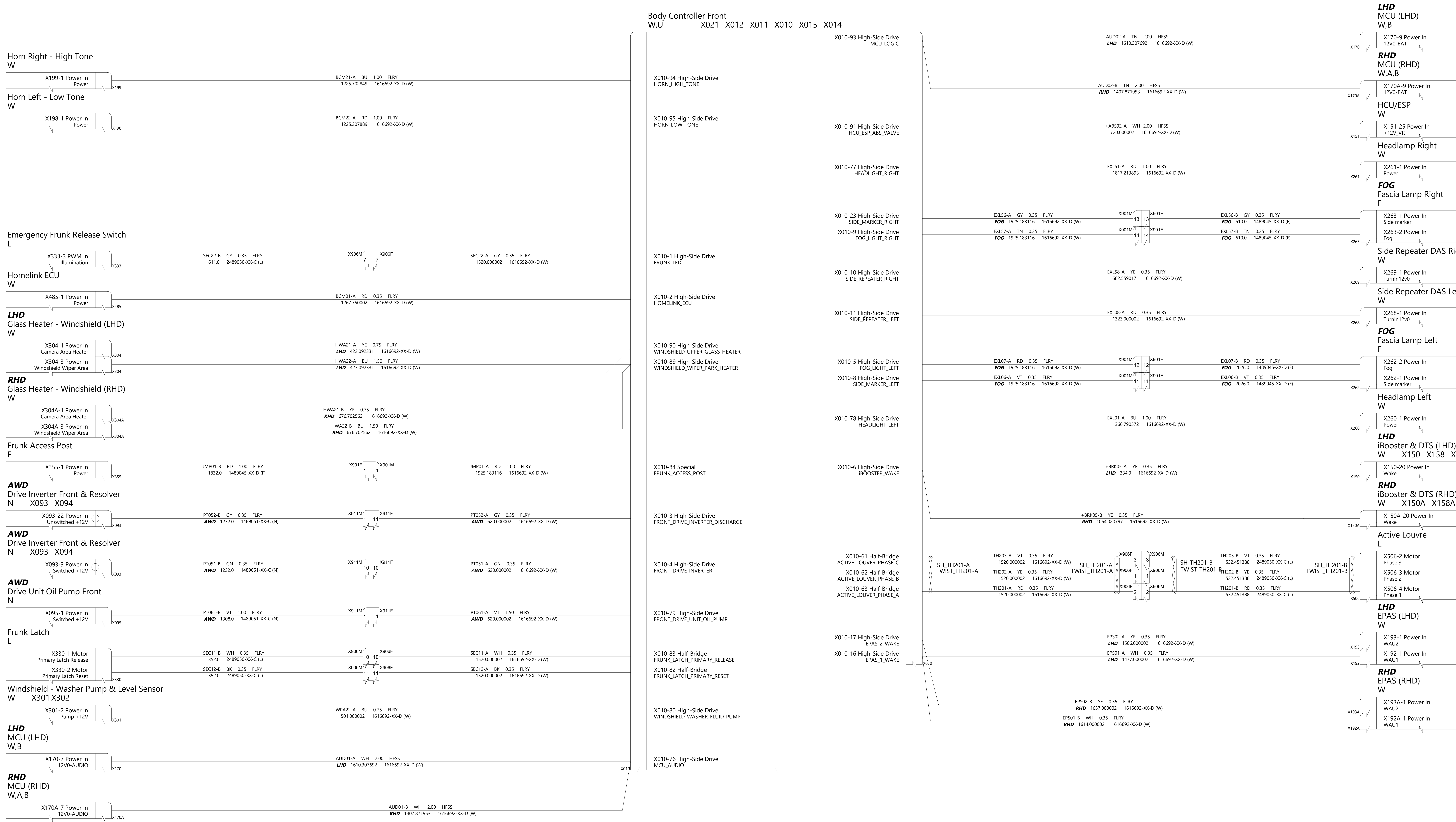

TESLA

THE INFORMATION CONTAINED HEREIN IS DEEMED TO BE CONFIDENTIAL, PROPRIETARY, AND A TRADE SECRET OF TESLA MOTORS. THIS INFORMATION MAY NOT BE USED, REPRODUCED, OR DISCLOSED AS THE DIRECT OR INDIRECT BASIS FOR THE DEVELOPMENT, MANUFACTURE, OR SALE OF PROCESSES OR PRODUCTS WITHOUT THE EXPRESSED WRITTEN CONSENT OF TESLA MOTORS.

DRAWN	CHECKED	APPROVED
MATERIAL AS SPECIFIED	FINISHING AS SPECIFIED	SCALE NONE
PART NAME Power Distribution - VCFront 1/2		
PART NUMBER	REV	SHEET
	1	33 OF 54
		SIZE A0

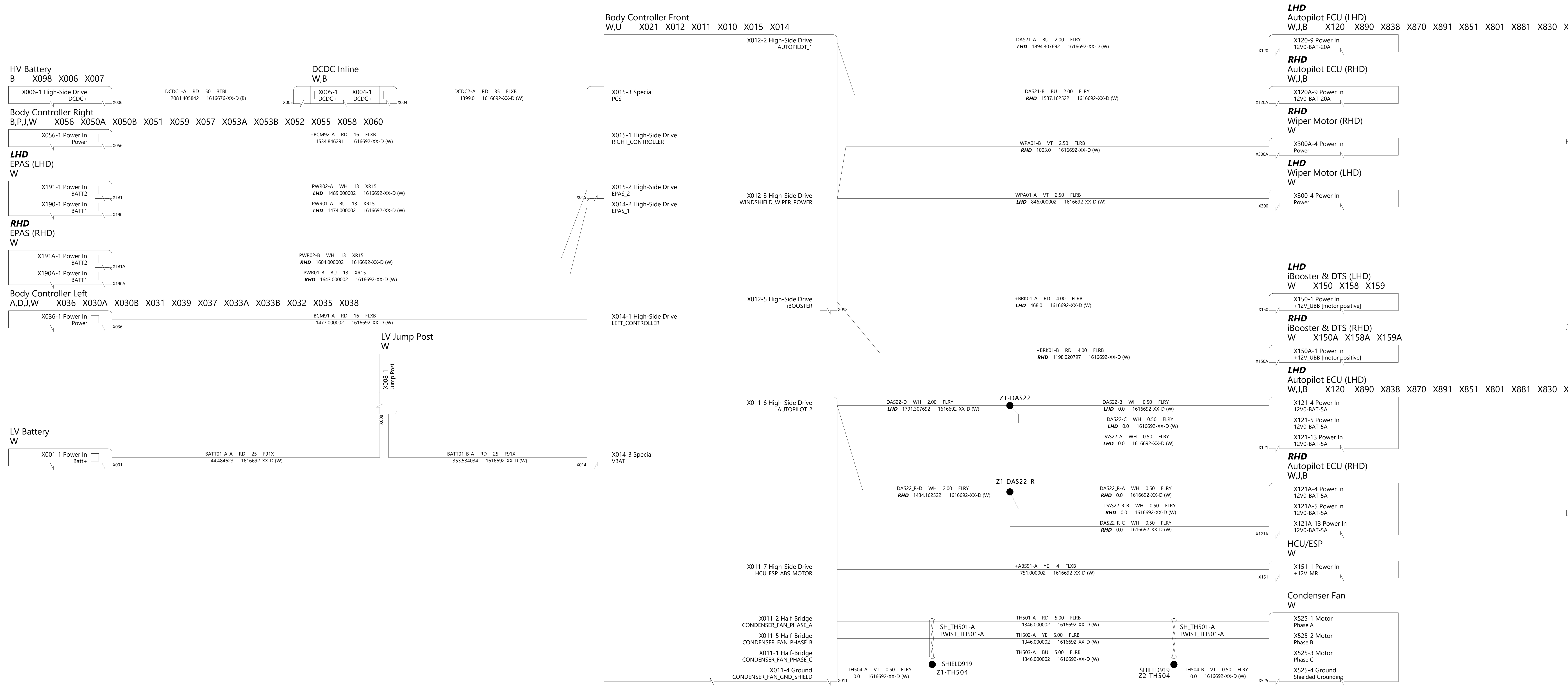

THE INFORMATION CONTAINED HEREIN IS DEEMED TO BE CONFIDENTIAL, PROPRIETARY, AND A TRADE SECRET OF TESLA MOTORS. THIS INFORMATION MAY NOT BE USED, REPRODUCED, OR DISCLOSED AS THE DIRECT OR INDIRECT BASIS FOR THE DEVELOPMENT, MANUFACTURE, OR SALE OF PROCESSES OR PRODUCTS WITHOUT THE EXPRESSED WRITTEN CONSENT OF TESLA MOTORS.

DRAWN	CHECKED	APPROVED
MATERIAL AS SPECIFIED	FINISHING AS SPECIFIED	SCALE NONE
PART NAME Power Distribution - VCFront 2/2		
PART NUMBER	REV	SHEET
	1	34 of 54
		SIZE A0

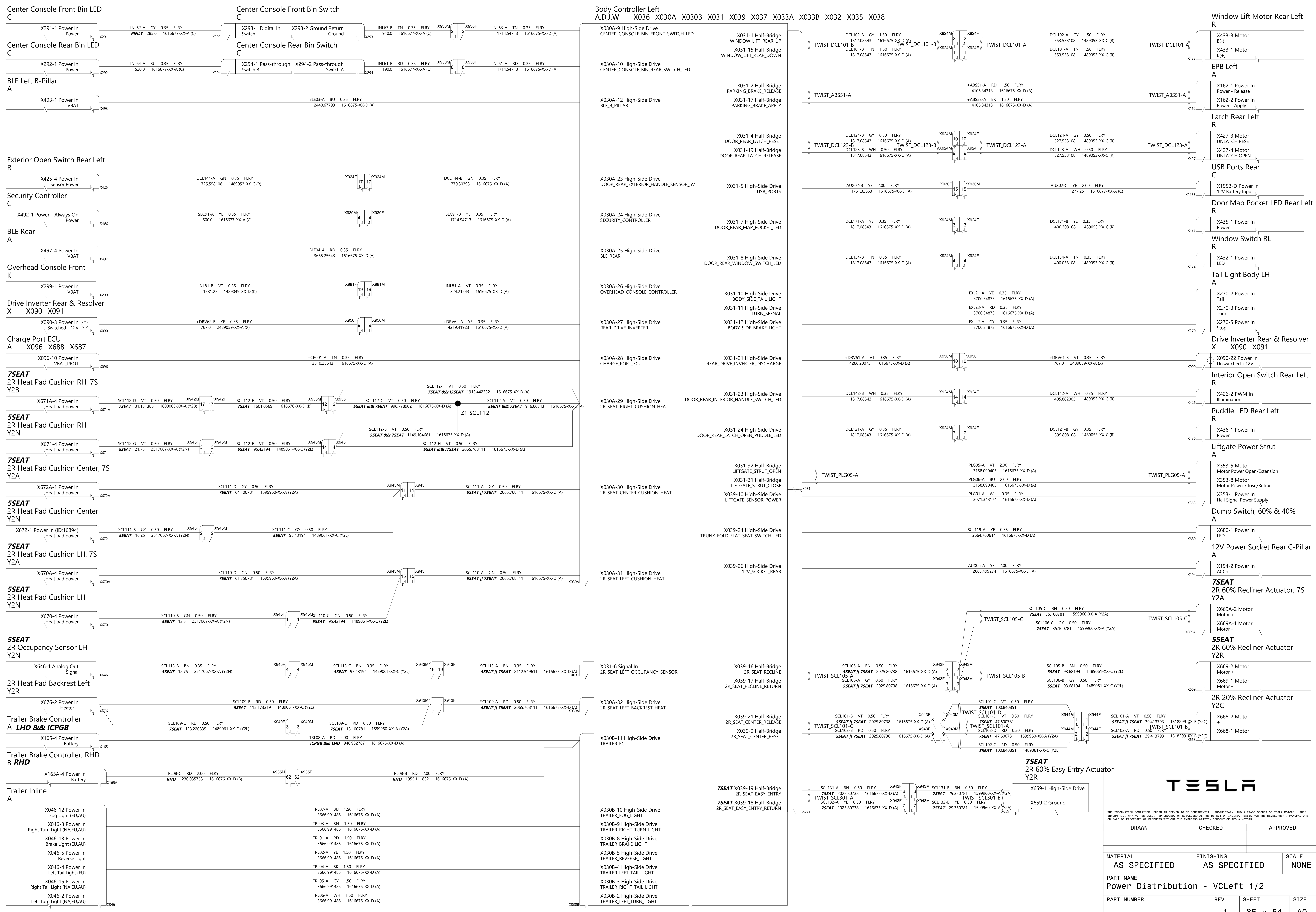

TESLA

THE INFORMATION CONTAINED HEREIN IS DEEMED TO BE CONFIDENTIAL, PROPRIETARY, AND A TRADE SECRET OF TESLA MOTORS. THIS INFORMATION MAY NOT BE USED, REPRODUCED, OR DISCLOSED AS THE DIRECT OR INDIRECT BASIS FOR THE DEVELOPMENT, MANUFACTURE, OR SALE OF PROCEDES OR PRODUCTS WITHOUT THE EXPRESSED WRITTEN CONSENT OF TESLA MOTORS.

DRAWN	CHECKED	APPROVED
MATERIAL AS SPECIFIED	FINISHING AS SPECIFIED	SCALE NONE
PART NAME Power Distribution - VCLeft 1/2		
PART NUMBER	REV	SHEET
	1	35 OF 54
		SIZE A0

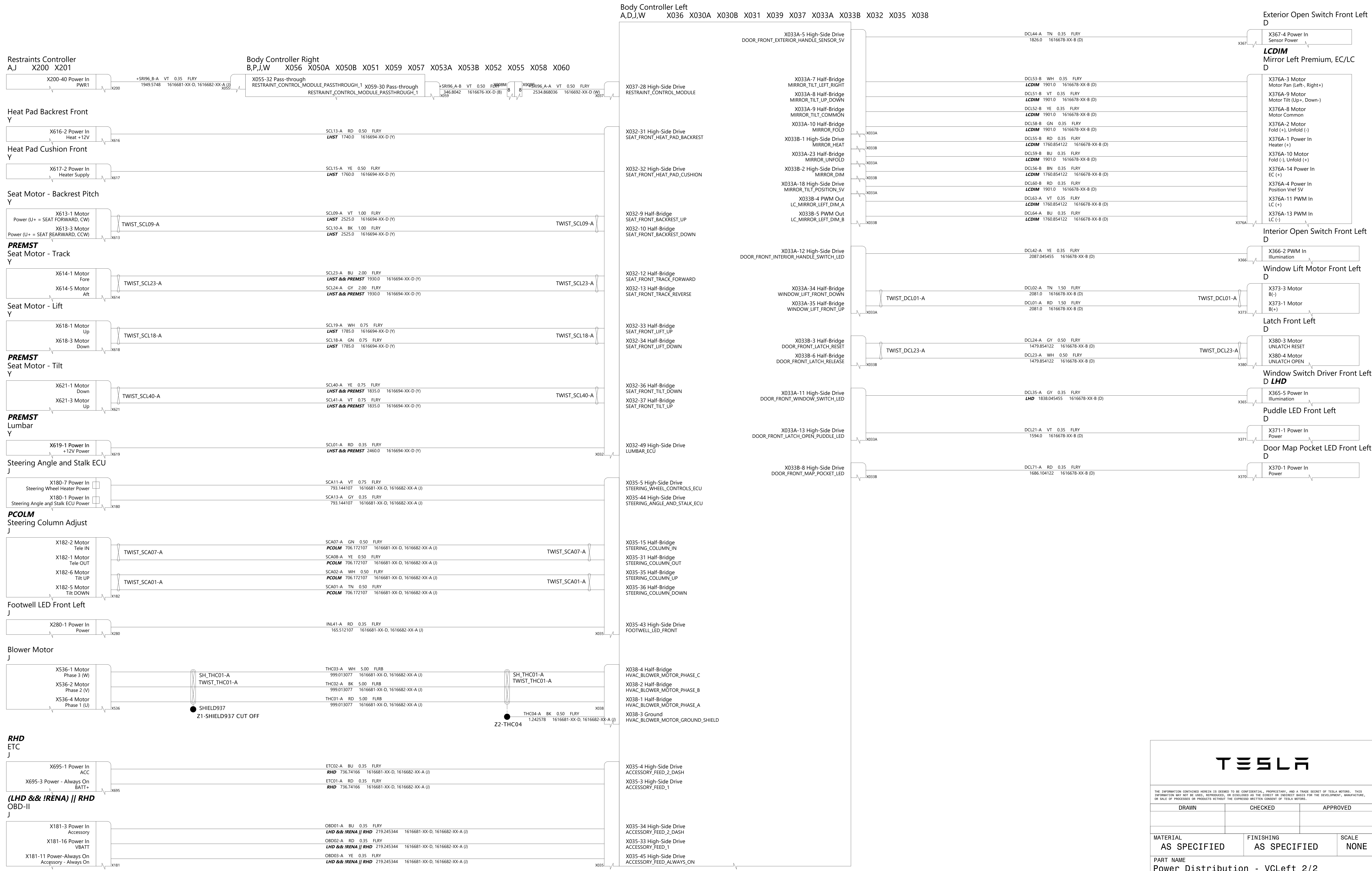

THE INFORMATION CONTAINED HEREIN IS DEEMED TO BE CONFIDENTIAL, PROPRIETARY, AND A TRADE SECRET OF TESLA MOTORS. THIS INFORMATION MAY NOT BE USED, REPRODUCED, OR DISCLOSED AS THE DIRECT OR INDIRECT BASIS FOR THE DEVELOPMENT, MANUFACTURE, OR SALE OF PROCESSES OR PRODUCTS WITHOUT THE EXPRESSED WRITTEN CONSENT OF TESLA MOTORS.

DRAWN	CHECKED	APPROVED
MATERIAL AS SPECIFIED	FINISHING AS SPECIFIED	SCALE NONE
PART NAME Power Distribution - VLeft 2/2		
PART NUMBER	REV	SHEET
	1	36 OF 54
		SIZE A0



THE INFORMATION CONTAINED HEREIN IS DEEMED TO BE CONFIDENTIAL, PROPRIETARY, AND A TRADE SECRET OF TESLA MOTORS. THIS INFORMATION MAY NOT BE USED, REPRODUCED, OR DISCLOSED AS THE DIRECT OR INDIRECT BASIS FOR THE DEVELOPMENT, MANUFACTURE, OR SALE OF PROCEDES OF PRODUCTS WITHOUT THE EXPRESSED WRITTEN CONSENT OF TESLA MOTORS.

DRAWN	CHECKED	APPROVED

MATERIAL	FINISHING	SCALE
AS SPECIFIED	AS SPECIFIED	NONE

PART NAME			
Power Distribution - VCRight 1/2			
PART NUMBER	REV	SHEET	SIZE
	1	37 OF 54	A0

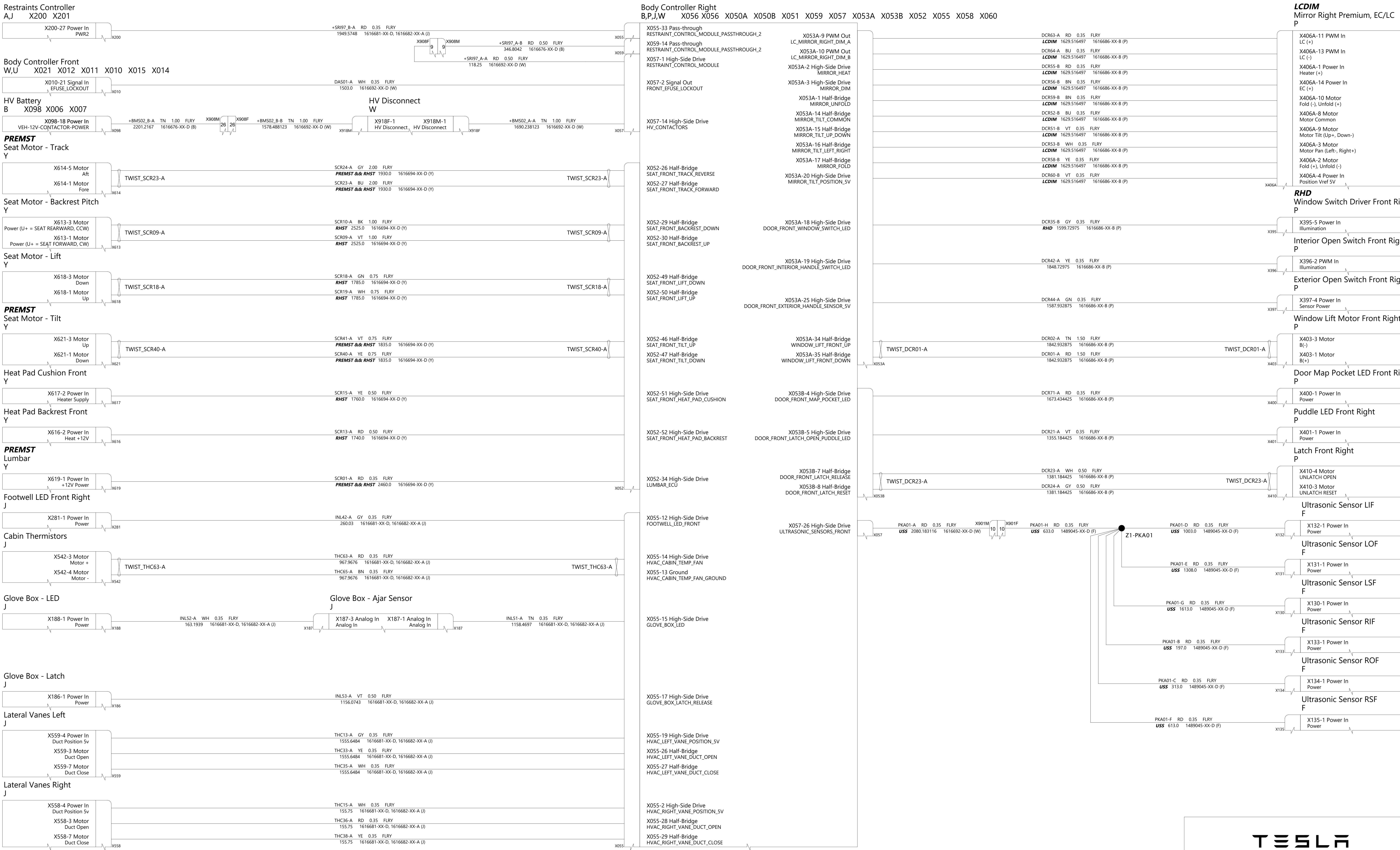

TESLA			
THE INFORMATION CONTAINED HEREIN IS DEEMED TO BE CONFIDENTIAL, PROPRIETARY, AND A TRADE SECRET OF TESLA MOTORS. THIS INFORMATION MAY NOT BE USED, REPRODUCED, OR DISCLOSED AS THE DIRECT OR INDIRECT BASIS FOR THE DEVELOPMENT, MANUFACTURE, OR SALE OF PROCESSES OR PRODUCTS WITHOUT THE EXPRESSED WRITTEN CONSENT OF TESLA MOTORS.			
DRAWN	CHECKED	APPROVED	
MATERIAL AS SPECIFIED	FINISHING AS SPECIFIED	SCALE NONE	
PART NAME Power Distribution - VCRight 2/2			
PART NUMBER	REV	SHEET	SIZE
	1	38 OF 54	A0

Restraints Controller
A,J X200 X201

Steering Angle and Stalk ECU
J

Airbag - Driver
Steering Wheel



THE INFORMATION CONTAINED HEREIN IS DEEMED TO BE CONFIDENTIAL, PROPRIETARY, AND A TRADE SECRET OF TESLA MOTORS. THIS INFORMATION MAY NOT BE USED, REPRODUCED, OR DISCLOSED AS THE DIRECT OR INDIRECT BASIS FOR THE DEVELOPMENT, MANUFACTURE, OR SALE OF PROCEDES OR PRODUCTS WITHOUT THE EXPRESSED WRITTEN CONSENT OF TESLA MOTORS.

DRAWN	CHECKED	APPROVED
MATERIAL AS SPECIFIED	FINISHING AS SPECIFIED	SCALE NONE
PART NAME Restraints Controller - Airbags		
PART NUMBER	REV	SHEET
	1	39 OF 54
		SIZE A0

Restraints Controller
A,J X200 X201

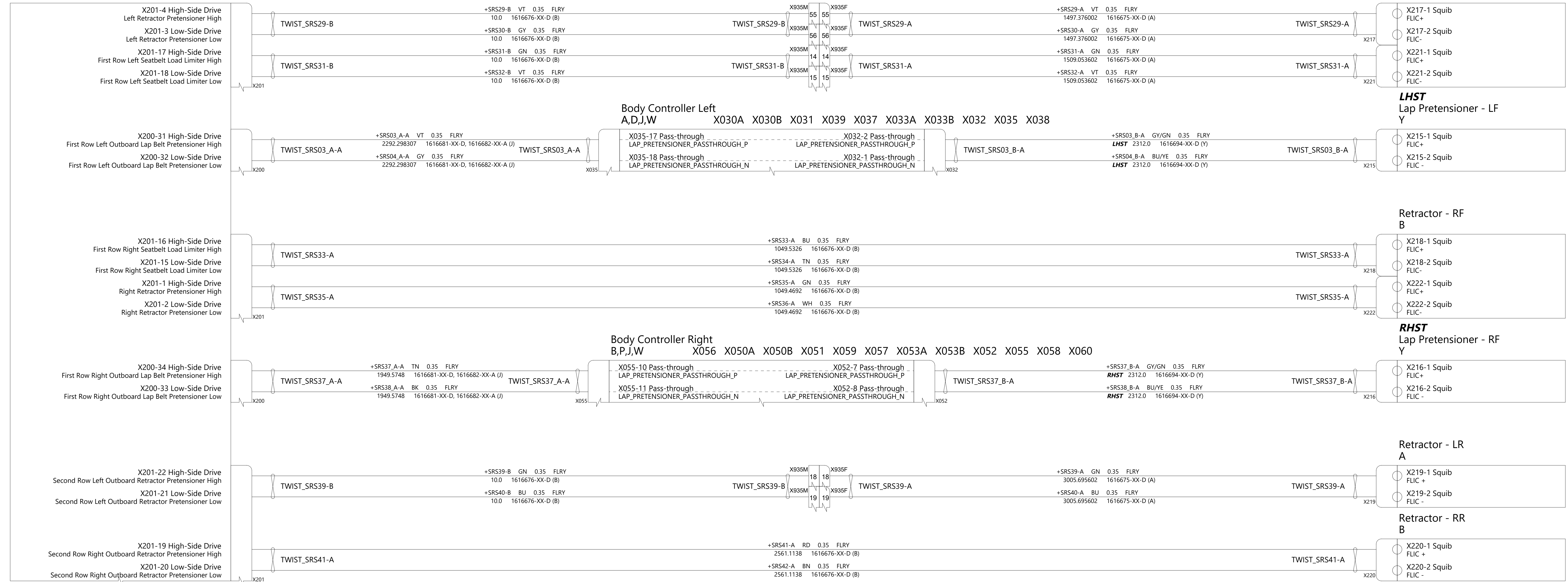

THE INFORMATION CONTAINED HEREIN IS DEEMED TO BE CONFIDENTIAL, PROPRIETARY, AND A TRADE SECRET OF TESLA MOTORS. THIS INFORMATION MAY NOT BE USED, REPRODUCED, OR DISCLOSED AS THE DIRECT OR INDIRECT BASIS FOR THE DEVELOPMENT, MANUFACTURE, OR SALE OF PROCESSES OR PRODUCTS WITHOUT THE EXPRESSED WRITTEN CONSENT OF TESLA MOTORS.

DRAWN	CHECKED	APPROVED
MATERIAL AS SPECIFIED	FINISHING AS SPECIFIED	SCALE NONE
PART NAME Restraints Controller - Retractors		
PART NUMBER	REV	SHEET
	1	40 OF 54
		SIZE A0

Restraints Controller
A,J X200 X201

Body Controller Right
B,P,J,W X056 X050A X050B X051 X059 X057 X053A X053B X052 X055 X058 X060

LHD
MCU (LHD)
W,B

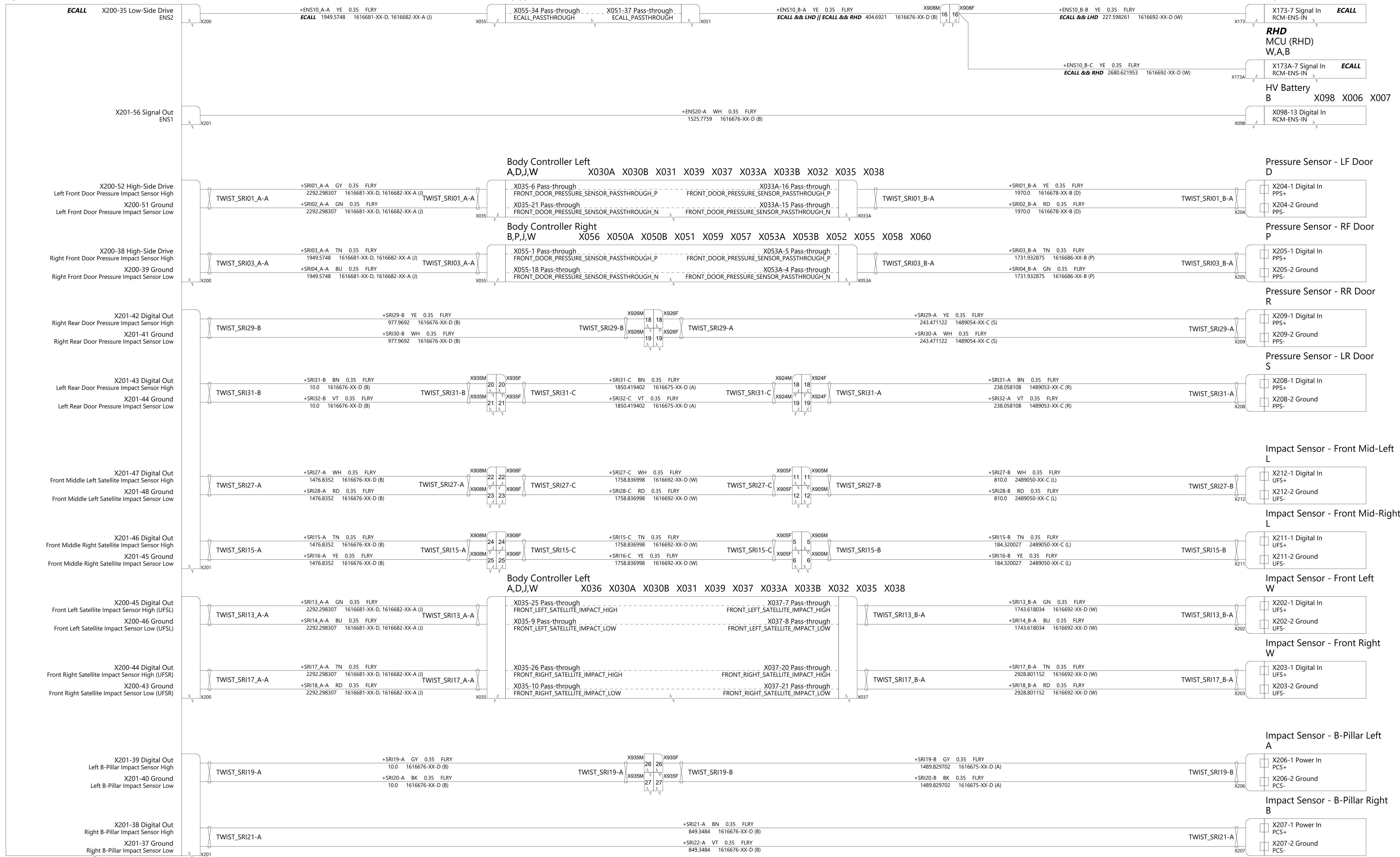

THE INFORMATION CONTAINED HEREIN IS DEEMED TO BE CONFIDENTIAL, PROPRIETARY, AND A TRADE SECRET OF TESLA MOTORS. THIS INFORMATION MAY NOT BE USED, REPRODUCED, OR DISCLOSED AS THE DIRECT OR INDIRECT BASIS FOR THE DEVELOPMENT, MANUFACTURE, OR SALE OF PROCESSES OR PRODUCTS WITHOUT THE EXPRESSED WRITTEN CONSENT OF TESLA MOTORS.

DRAWN	CHECKED	APPROVED
MATERIAL AS SPECIFIED	FINISHING AS SPECIFIED	SCALE NONE
PART NAME Restraints Controller - Sensors		
PART NUMBER	REV	SHEET
	1	41 OF 54
		SIZE A0

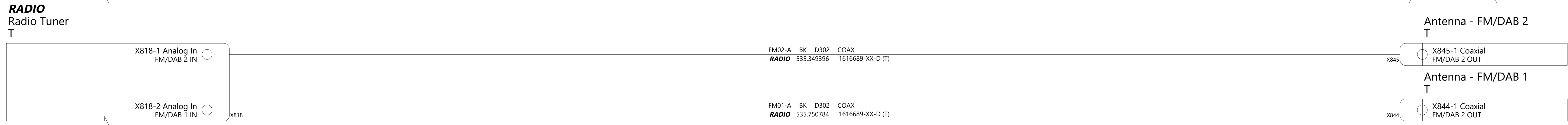
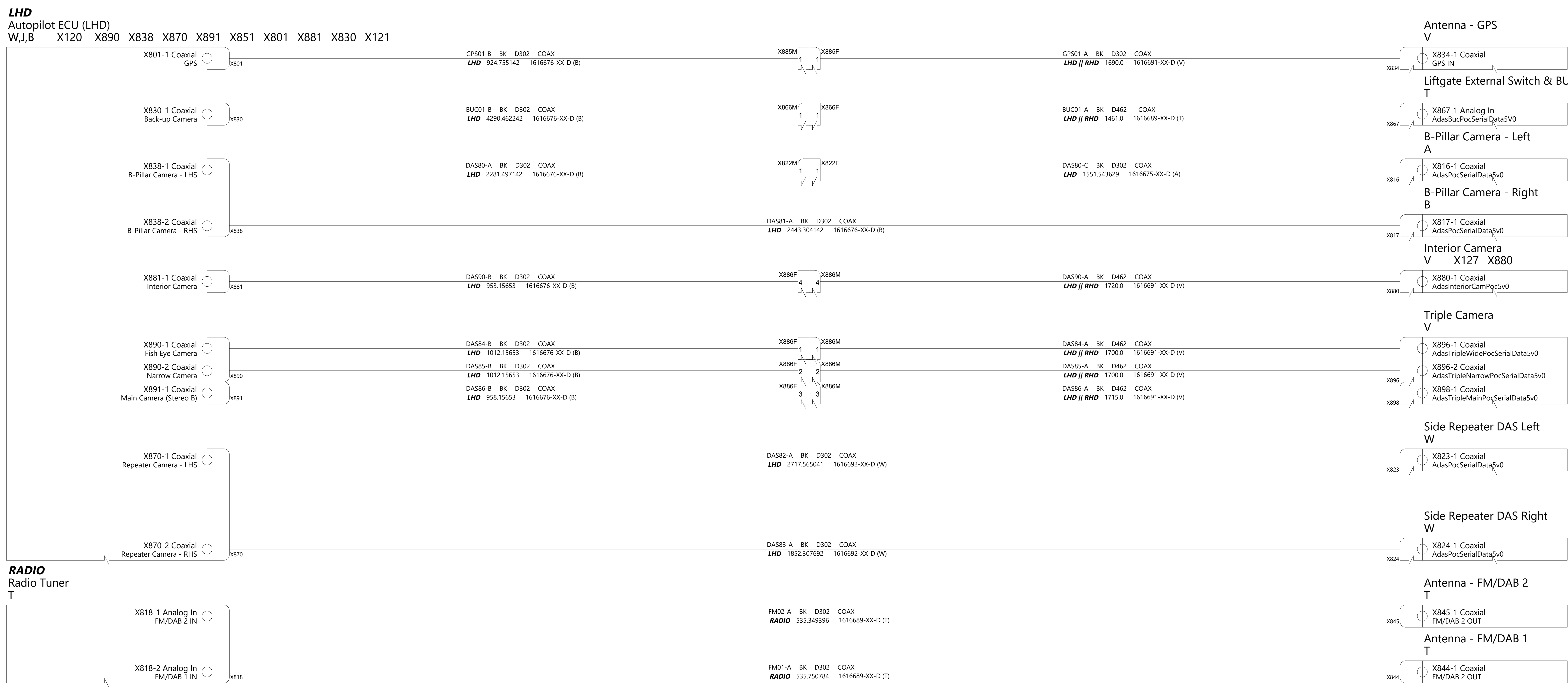

TESLA

THE INFORMATION CONTAINED HEREIN IS DEEMED TO BE CONFIDENTIAL, PROPRIETARY, AND A TRADE SECRET OF TESLA MOTORS. THIS INFORMATION MAY NOT BE USED, REPRODUCED, OR DISCLOSED AS THE DIRECT OR INDIRECT BASIS FOR THE DEVELOPMENT, MANUFACTURE, OR SALE OF PROCESSES OR PRODUCTS WITHOUT THE EXPRESSED WRITTEN CONSENT OF TESLA MOTORS.

DRAWN	CHECKED	APPROVED
MATERIAL AS SPECIFIED	FINISHING AS SPECIFIED	SCALE NONE
PART NAME RF/Special Cables		
PART NUMBER	REV	SHEET
	1	42 OF 54
		SIZE A0

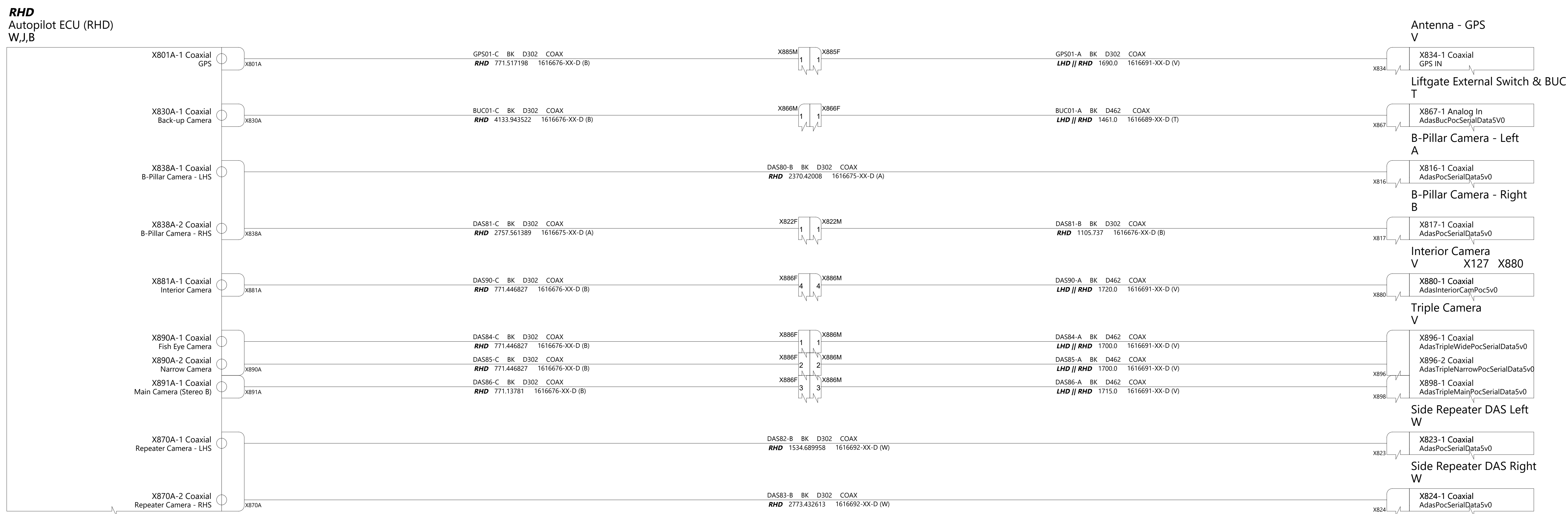
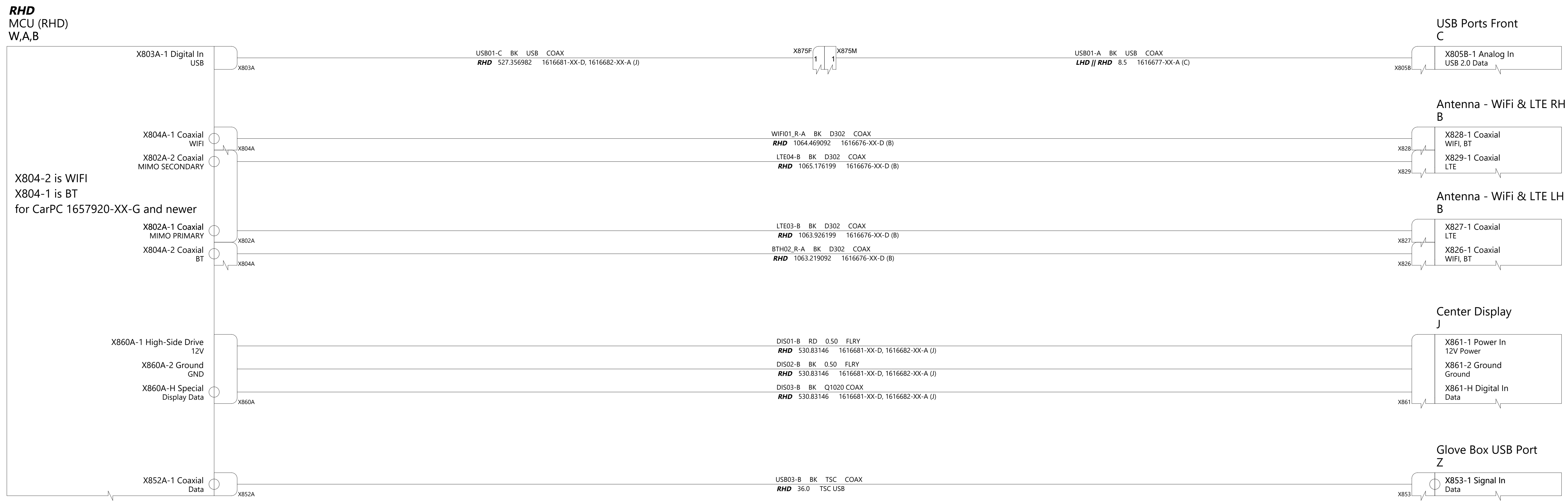

TESLA

THE INFORMATION CONTAINED HEREIN IS DEEMED TO BE CONFIDENTIAL, PROPRIETARY, AND A TRADE SECRET OF TESLA MOTORS. THIS INFORMATION MAY NOT BE USED, REPRODUCED, OR DISCLOSED AS THE DIRECT OR INDIRECT BASIS FOR THE DEVELOPMENT, MANUFACTURE, OR SALE OF PROCESSES OR PRODUCTS WITHOUT THE EXPRESSED WRITTEN CONSENT OF TESLA MOTORS.

DRAWN	CHECKED	APPROVED

MATERIAL	FINISHING	SCALE
AS SPECIFIED	AS SPECIFIED	NONE

PART NAME
RF/Special Cables, RHD

PART NUMBER	REV	SHEET	SIZE
	1	43 of 54	A0

Body Controller Left
A,D,J,W X036 X030A X030B X031

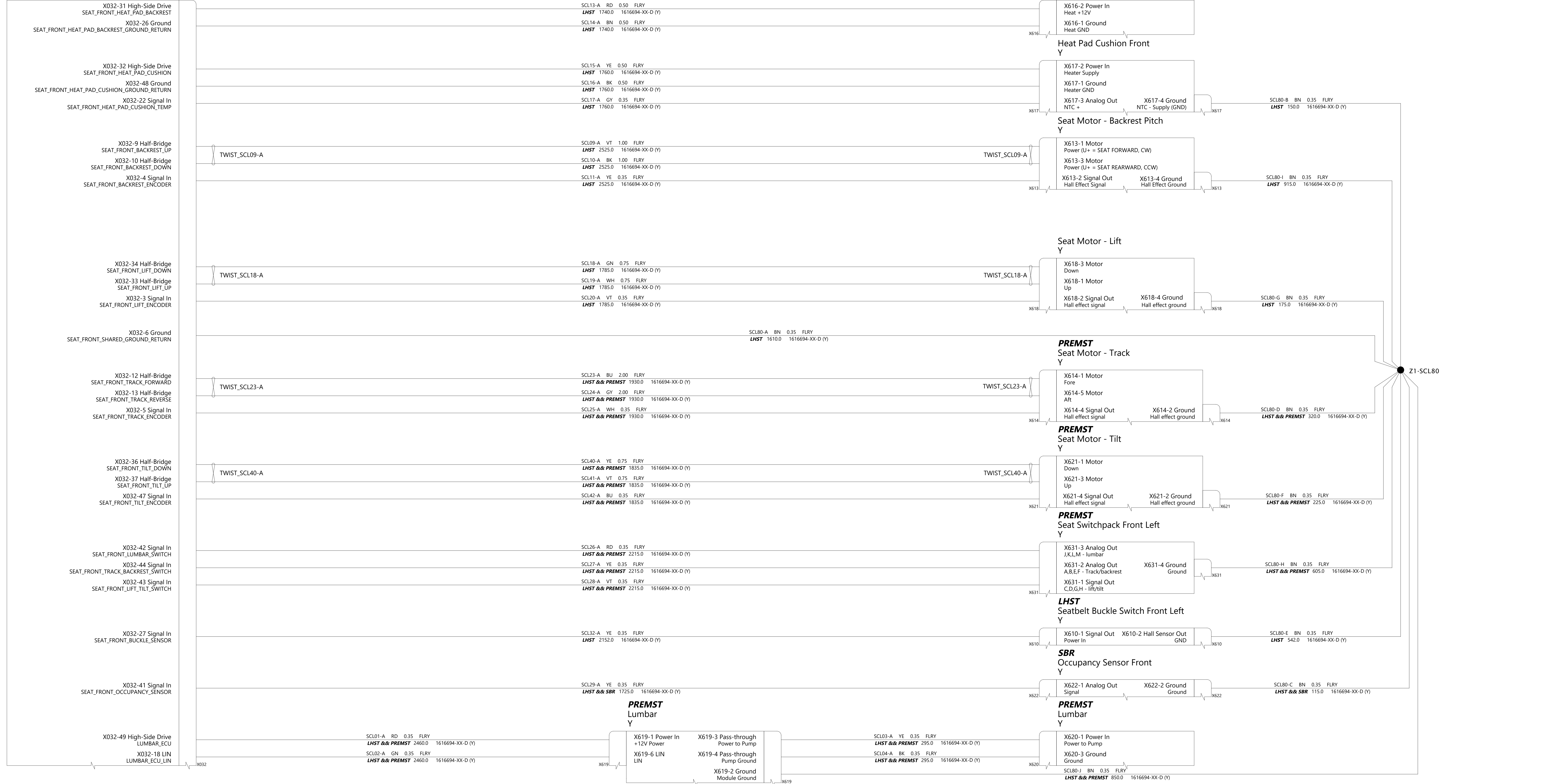

THE INFORMATION CONTAINED HEREIN IS DEEMED TO BE CONFIDENTIAL, PROPRIETARY, AND A TRADE SECRET OF TESLA MOTORS. THIS INFORMATION MAY NOT BE USED, REPRODUCED, OR DISCLOSED AS THE DIRECT OR INDIRECT BASIS FOR THE DEVELOPMENT, MANUFACTURE, OR SALE OF PROCESSES OR PRODUCTS WITHOUT THE EXPRESSED WRITTEN CONSENT OF TESLA MOTORS.

DRAWN	CHECKED	APPROVED
MATERIAL AS SPECIFIED	FINISHING AS SPECIFIED	SCALE NONE
PART NAME Seats Front Left		
PART NUMBER	REV	SHEET
	1	44 OF 54
		SIZE A0

Body Controller Right
B,P,J,W X056 X050A X050B X051 X059 X057 X053A X053B X052 X055 X058 X060

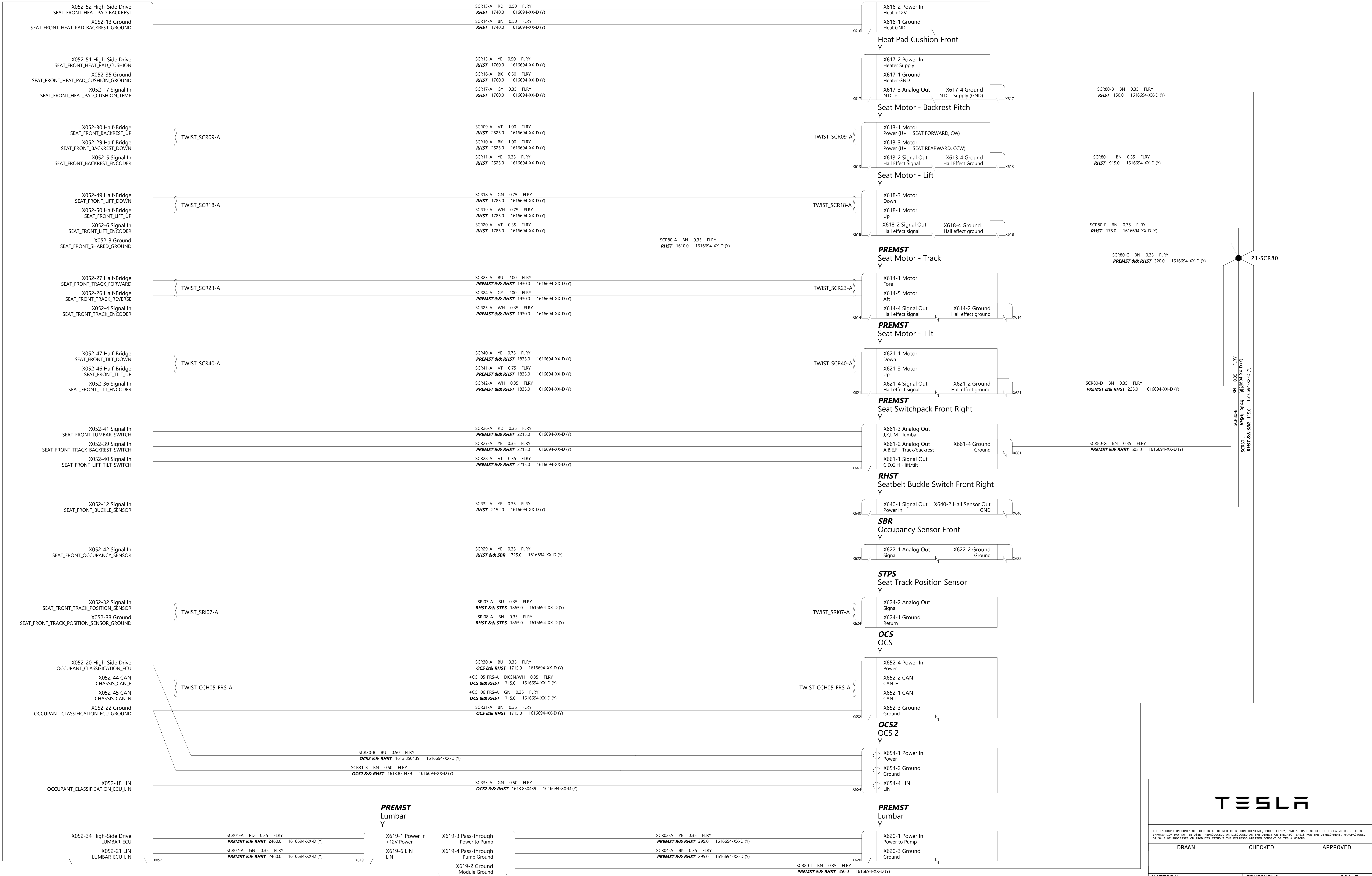

THE INFORMATION CONTAINED HEREIN IS DEEMED TO BE CONFIDENTIAL, PROPRIETARY, AND A TRADE SECRET OF TESLA MOTORS. THIS INFORMATION MAY NOT BE USED, REPRODUCED, OR DISCLOSED AS THE DIRECT OR INDIRECT BASIS FOR THE DEVELOPMENT, MANUFACTURE, OR SALE OF PROCESSES OR PRODUCTS WITHOUT THE EXPRESSED WRITTEN CONSENT OF TESLA MOTORS.

DRAWN	CHECKED	APPROVED
MATERIAL AS SPECIFIED	FINISHING AS SPECIFIED	SCALE NONE
PART NAME Seats Front Right		
PART NUMBER	REV	SHEET
	1	45 of 54
		SCALE A0

Body Controller Right
B,P,J,W X056 X056 X050A X050B X051 X059 X057 X053A X053B X052 X055 X058 X060

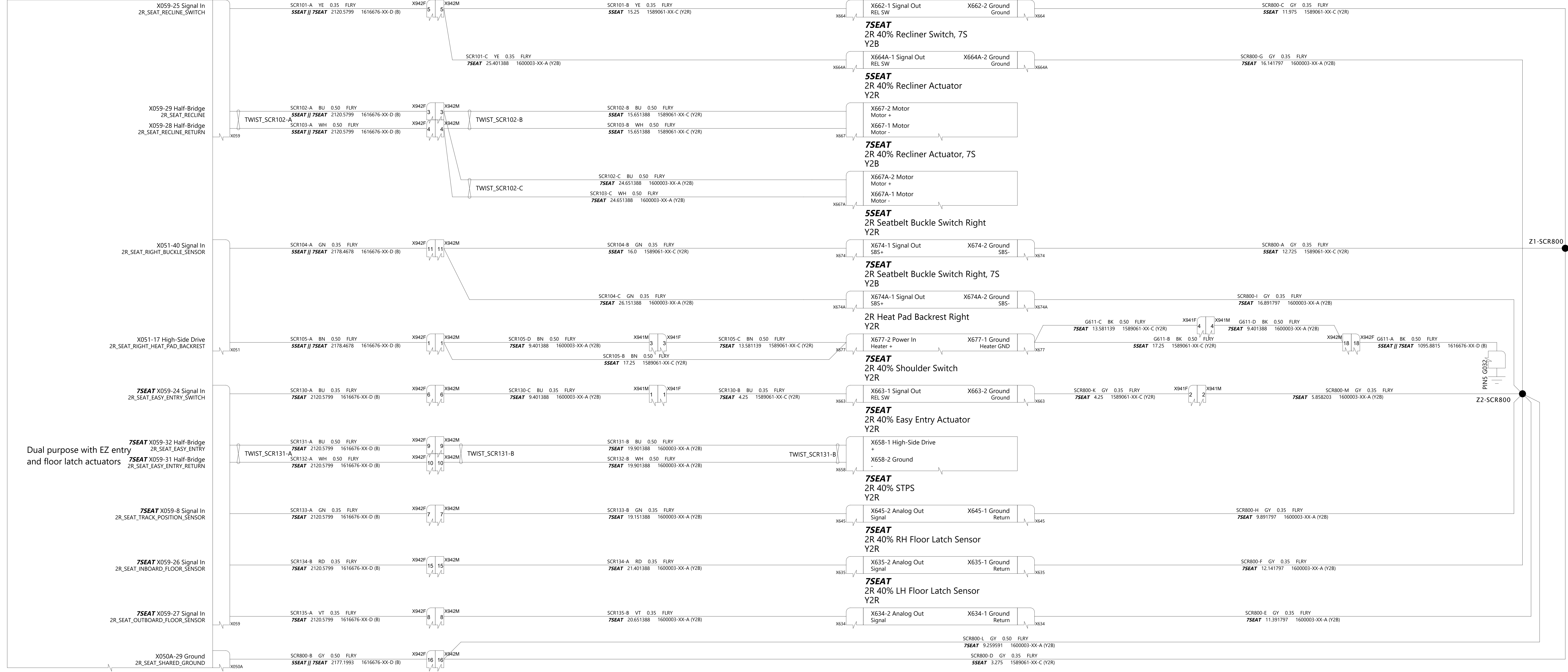

TESLA

THE INFORMATION CONTAINED HEREIN IS DEEMED TO BE CONFIDENTIAL, PROPRIETARY, AND A TRADE SECRET OF TESLA MOTORS. THIS INFORMATION MAY NOT BE USED, REPRODUCED, OR DISCLOSED AS THE DIRECT OR INDIRECT BASIS FOR THE DEVELOPMENT, MANUFACTURE, OR SALE OF PROCESSES OR PRODUCTS WITHOUT THE EXPRESS WRITTEN CONSENT OF TESLA MOTORS.

DRAWN	CHECKED	APPROVED
-------	---------	----------

MATERIAL AS SPECIFIED	FINISHING AS SPECIFIED	SCALE NONE
--------------------------	---------------------------	---------------

PART NAME
Seats Second Row 40%

PART NUMBER	REV	SHEET	SIZE
	1	46 OF 54	A0

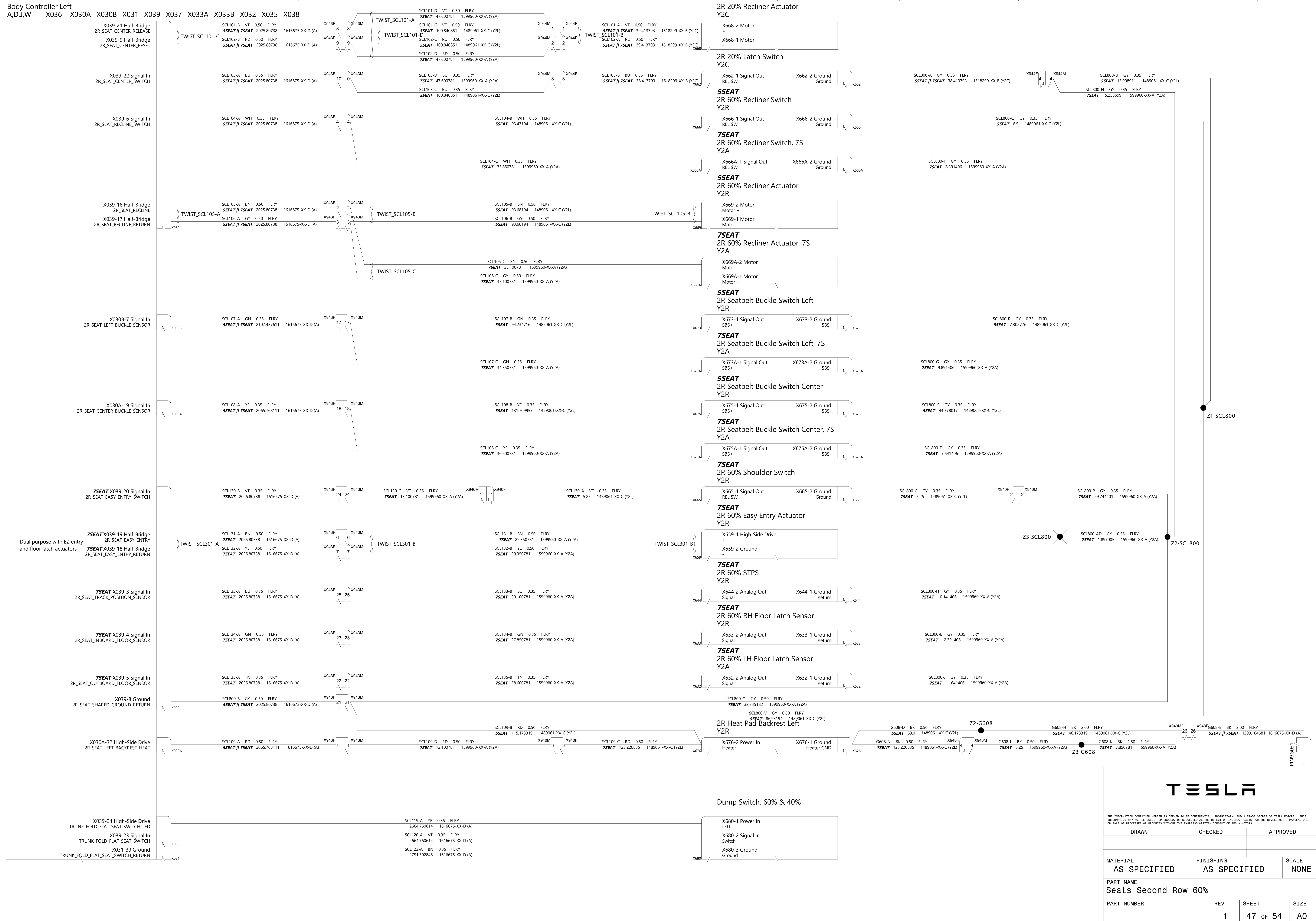

THE INFORMATION CONTAINED HEREIN IS DEEMED TO BE CONFIDENTIAL, PROPRIETARY, AND A TRADE SECRET OF TESLA MOTORS. THIS INFORMATION MAY NOT BE USED, REPRODUCED, OR DISCLOSED AS THE DIRECT OR INDIRECT BASIS FOR THE DEVELOPMENT, MANUFACTURE, OR SALE OF PROCESSES OR PRODUCTS WITHOUT THE EXPRESSED WRITTEN CONSENT OF TESLA MOTORS.

DRAWN	CHECKED	APPROVED	
MATERIAL AS SPECIFIED	FINISHING AS SPECIFIED	SCALE NONE	
PART NAME Seats Second Row 60%			
PART NUMBER	REV	SHEET	SIZE
	1	47 OF 54	A0

Body Controller Left
A,D,J,W X036 X030A X030B X031 X039 X037 X033A X033B X032 X035 X038

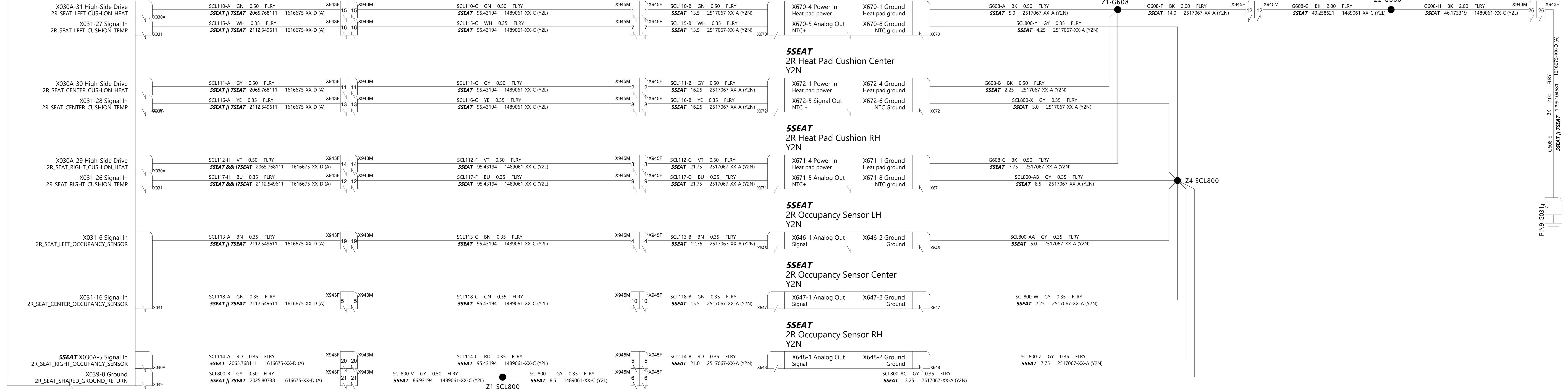

THE INFORMATION CONTAINED HEREIN IS DEEMED TO BE CONFIDENTIAL, PROPRIETARY, AND A TRADE SECRET OF TESLA MOTORS. THIS INFORMATION MAY NOT BE USED, REPRODUCED, OR DISCLOSED AS THE DIRECT OR INDIRECT BASIS FOR THE DEVELOPMENT, MANUFACTURE, OR SALE OF PROCESSES OR PRODUCTS WITHOUT THE EXPRESSED WRITTEN CONSENT OF TESLA MOTORS.

DRAWN	CHECKED	APPROVED
MATERIAL AS SPECIFIED	FINISHING AS SPECIFIED	SCALE NONE
PART NAME Seats Second Row Cushion 5-Seater		
PART NUMBER	REV	SHEET
	1	48 of 54
		SIZE A0

Body Controller Left
A,D,J,W

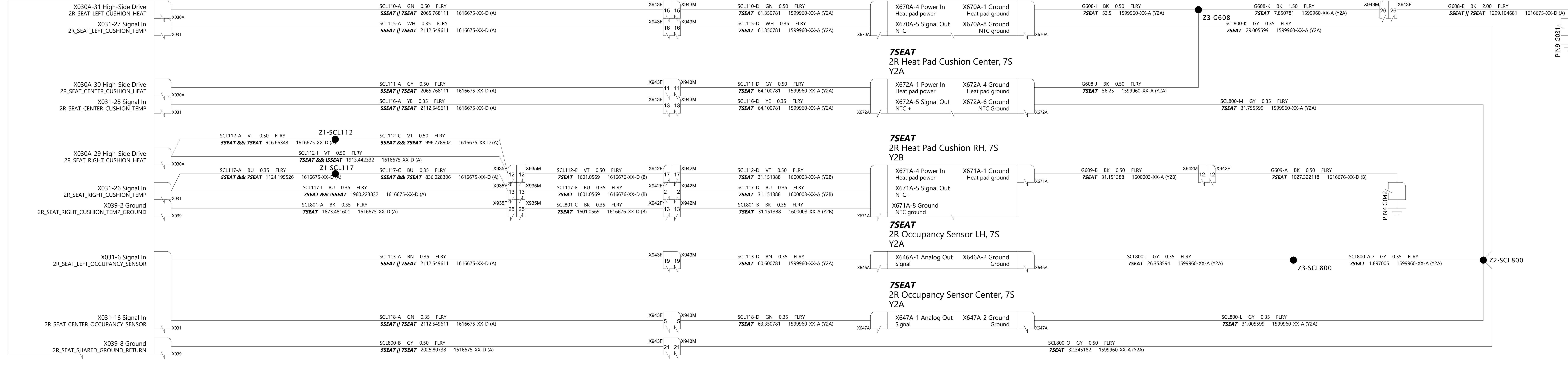

Body Controller Right
B,P,J,W

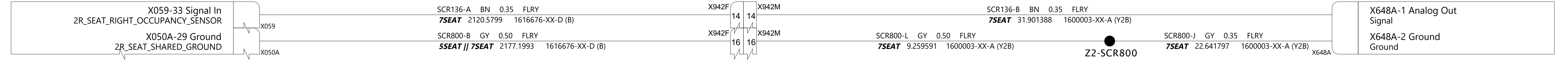

THE INFORMATION CONTAINED HEREIN IS DEEMED TO BE CONFIDENTIAL, PROPRIETARY, AND A TRADE SECRET OF TESLA MOTORS. THIS INFORMATION MAY NOT BE USED, REPRODUCED, OR DISCLOSED AS THE DIRECT OR INDIRECT BASIS FOR THE DEVELOPMENT, MANUFACTURE, OR SALE OF PROCESSES OR PRODUCTS WITHOUT THE EXPRESSED WRITTEN CONSENT OF TESLA MOTORS.

DRAWN	CHECKED	APPROVED
-------	---------	----------

MATERIAL AS SPECIFIED	FINISHING AS SPECIFIED	SCALE NONE
--------------------------	---------------------------	---------------

PART NAME
Seats Second Row Cushion 7-Seater

PART NUMBER	REV	SHEET	SIZE
	1	49 OF 54	A0

Body Controller Right
 B,P,I,W X056 X056 X050A X050B X051 X059 X057 X053A X053B X052 X055 X058 X060

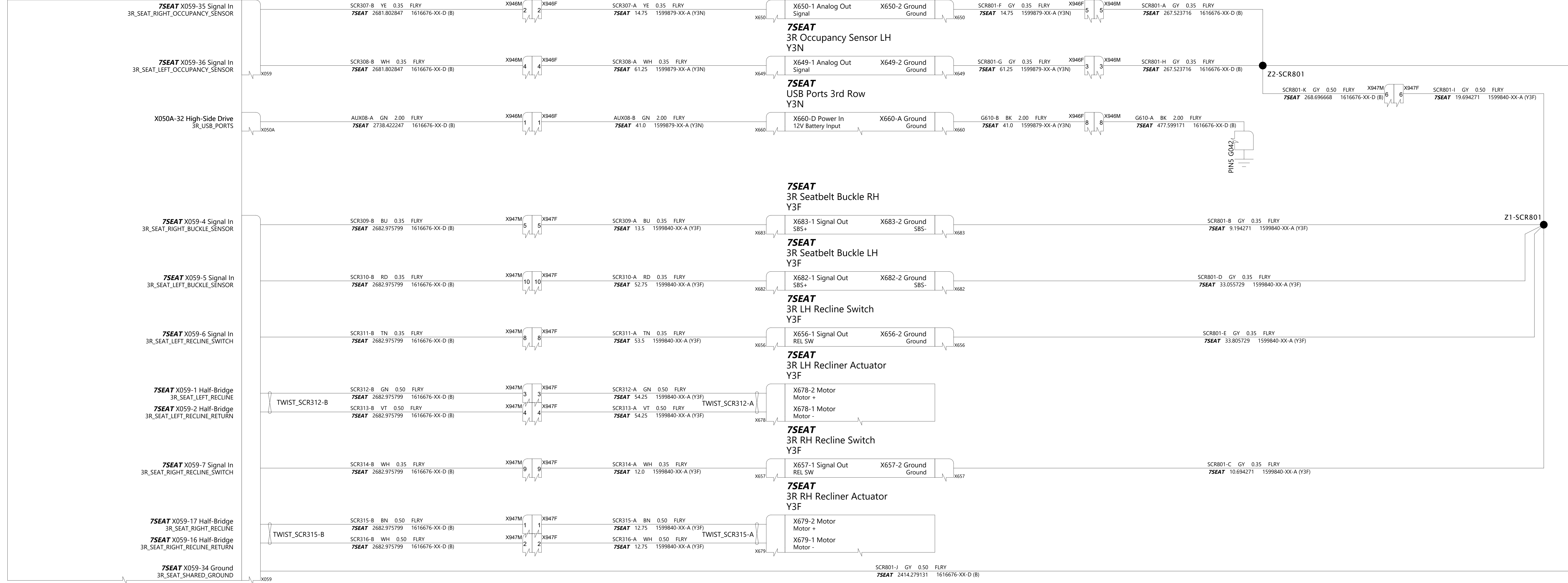

TESLA

THE INFORMATION CONTAINED HEREIN IS DEEMED TO BE CONFIDENTIAL, PROPRIETARY, AND A TRADE SECRET OF TESLA MOTORS. THIS INFORMATION MAY NOT BE USED, REPRODUCED, OR DISCLOSED AS THE DIRECT OR INDIRECT BASIS FOR THE DEVELOPMENT, MANUFACTURE, OR SALE OF PROCESSES OR PRODUCTS WITHOUT THE EXPRESSED WRITTEN CONSENT OF TESLA MOTORS.

DRAWN	CHECKED	APPROVED
MATERIAL AS SPECIFIED	FINISHING AS SPECIFIED	SCALE NONE
PART NAME Seats Third Row		
PART NUMBER	REV 1	SHEET 50 OF 54
		SIZE A0

Body Controller Left
A,D,J,W X030A X030B X031 X039 X037 X033A X033B X032 X035 X038

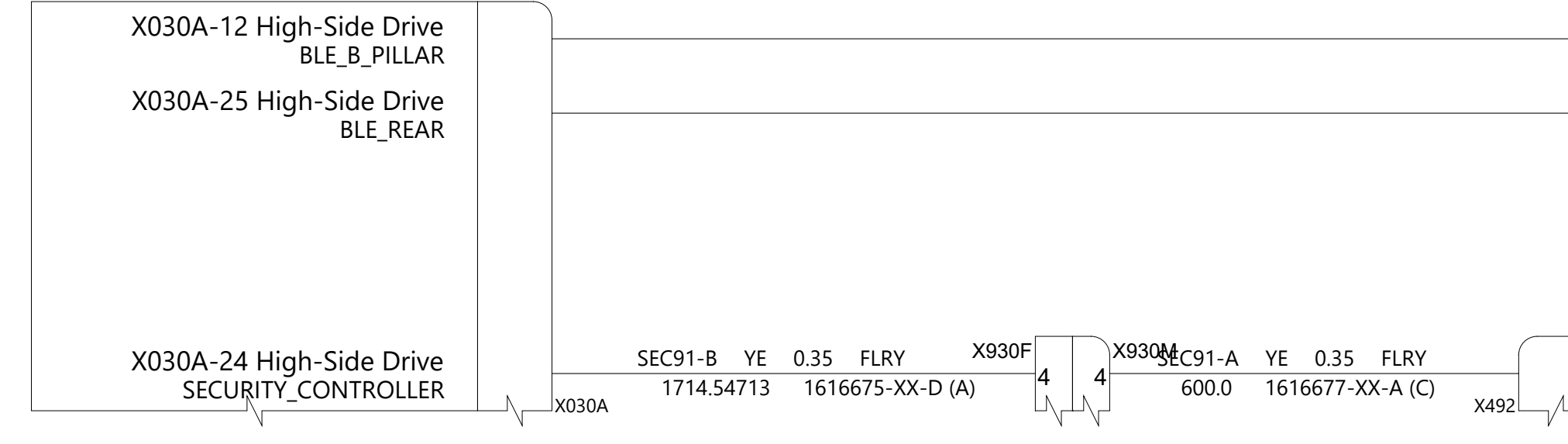

Security Controller
C

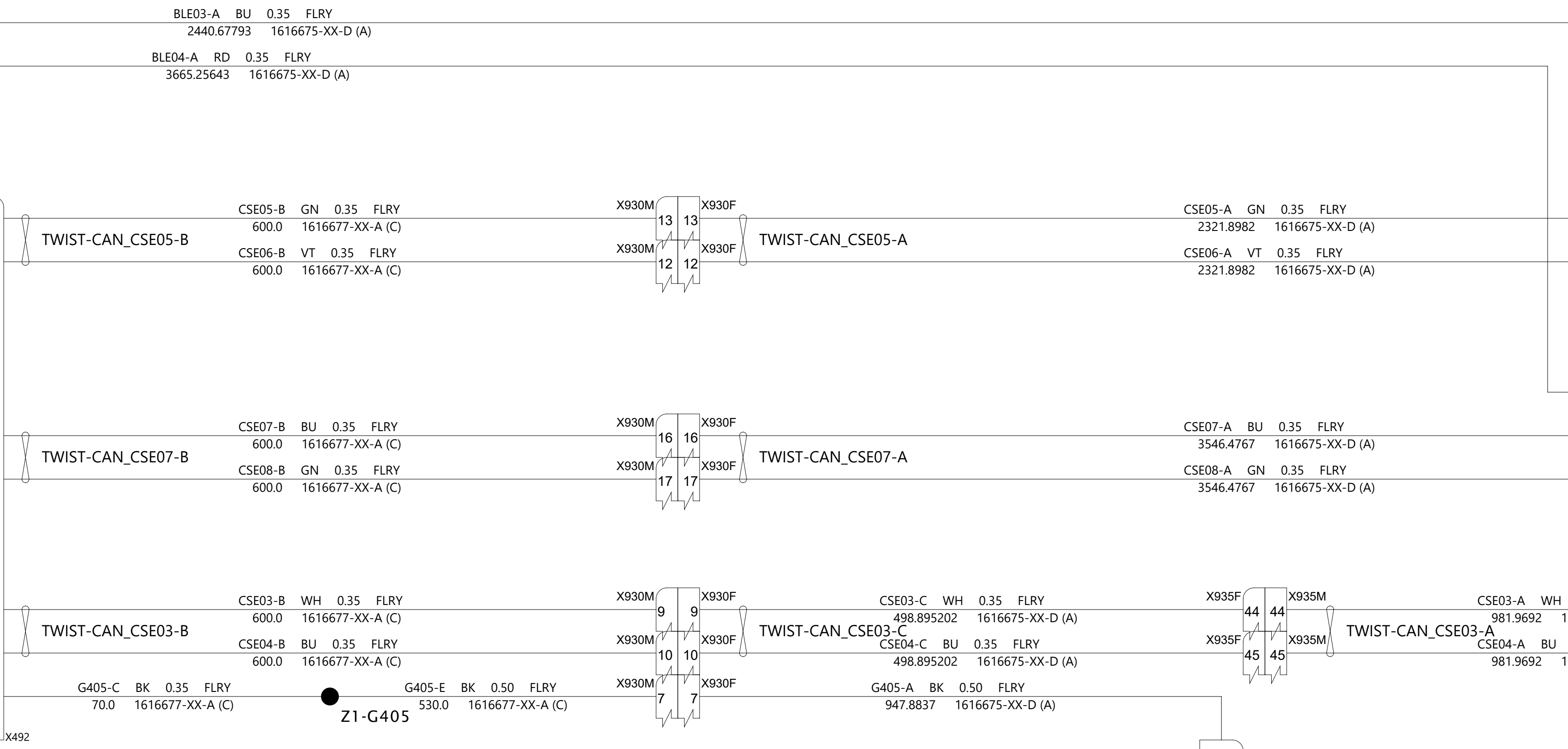
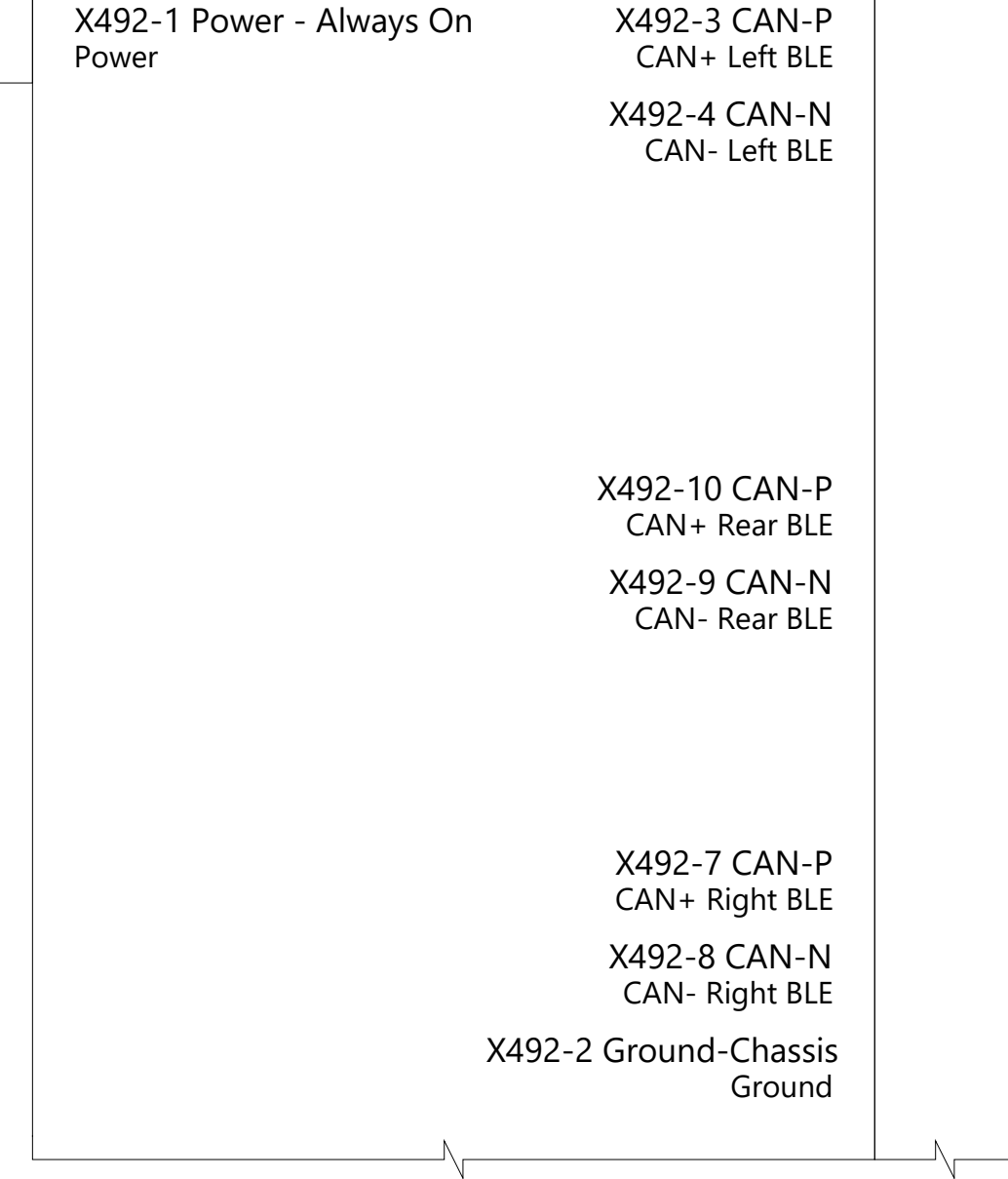

BLE Left B-Pillar
A

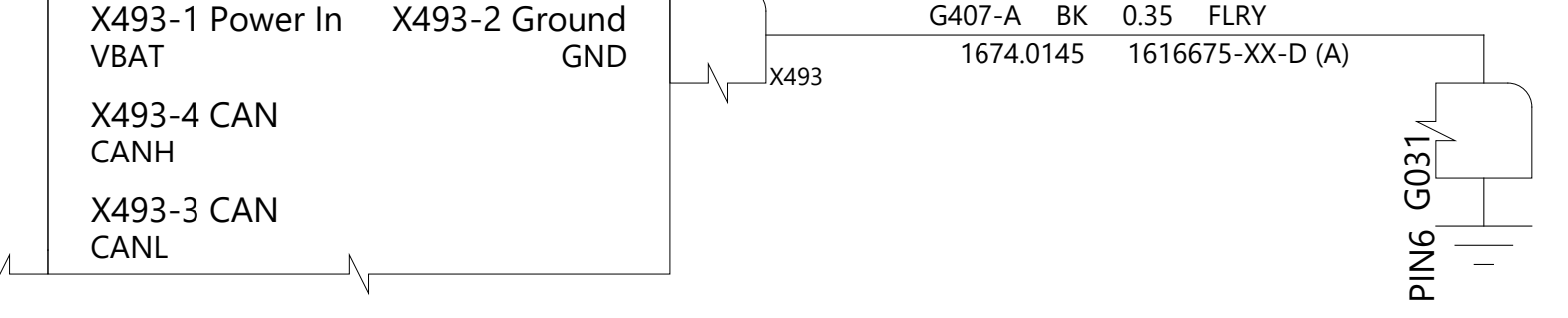

BLE Rear
A

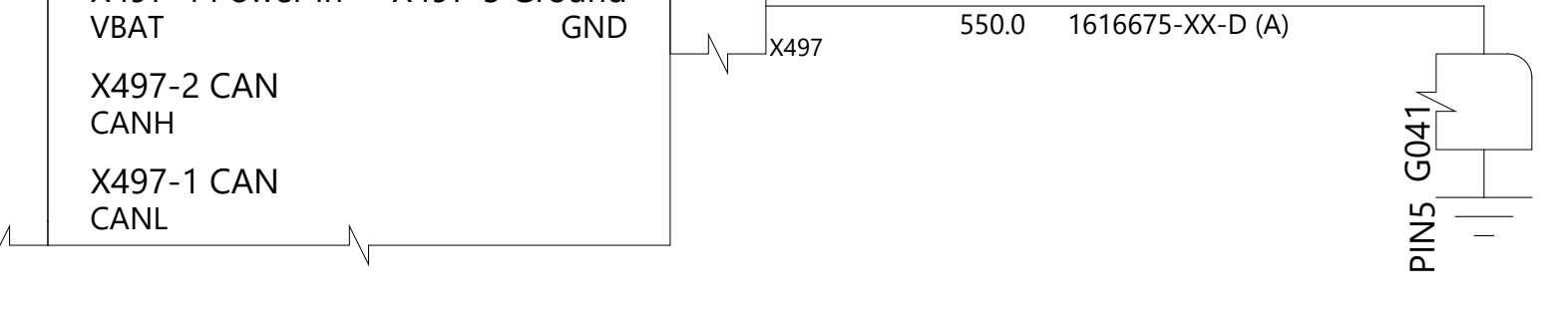

BLE Right B-Pillar
B

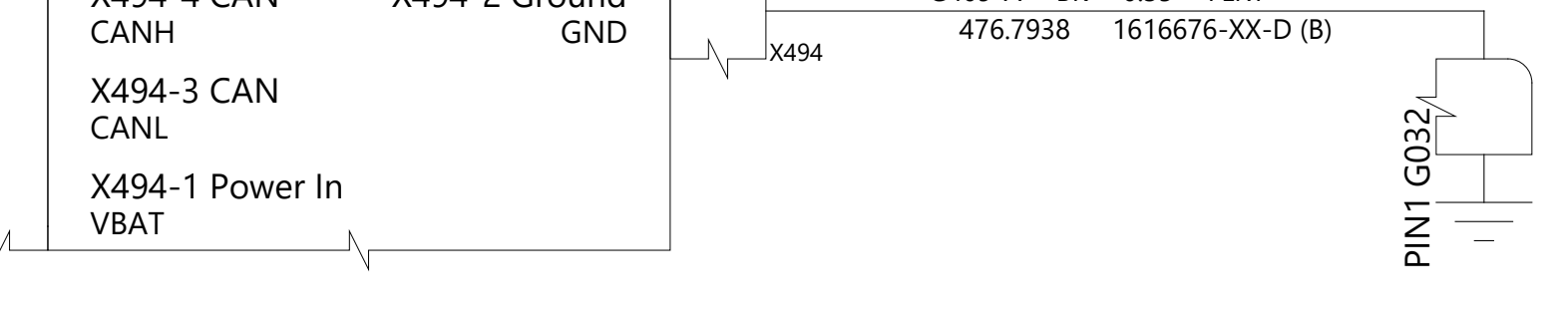

Body Controller Right
B,P,J,W X056 X050A X050B X051 X059 X057 X053A X053B X052 X055 X058 X060

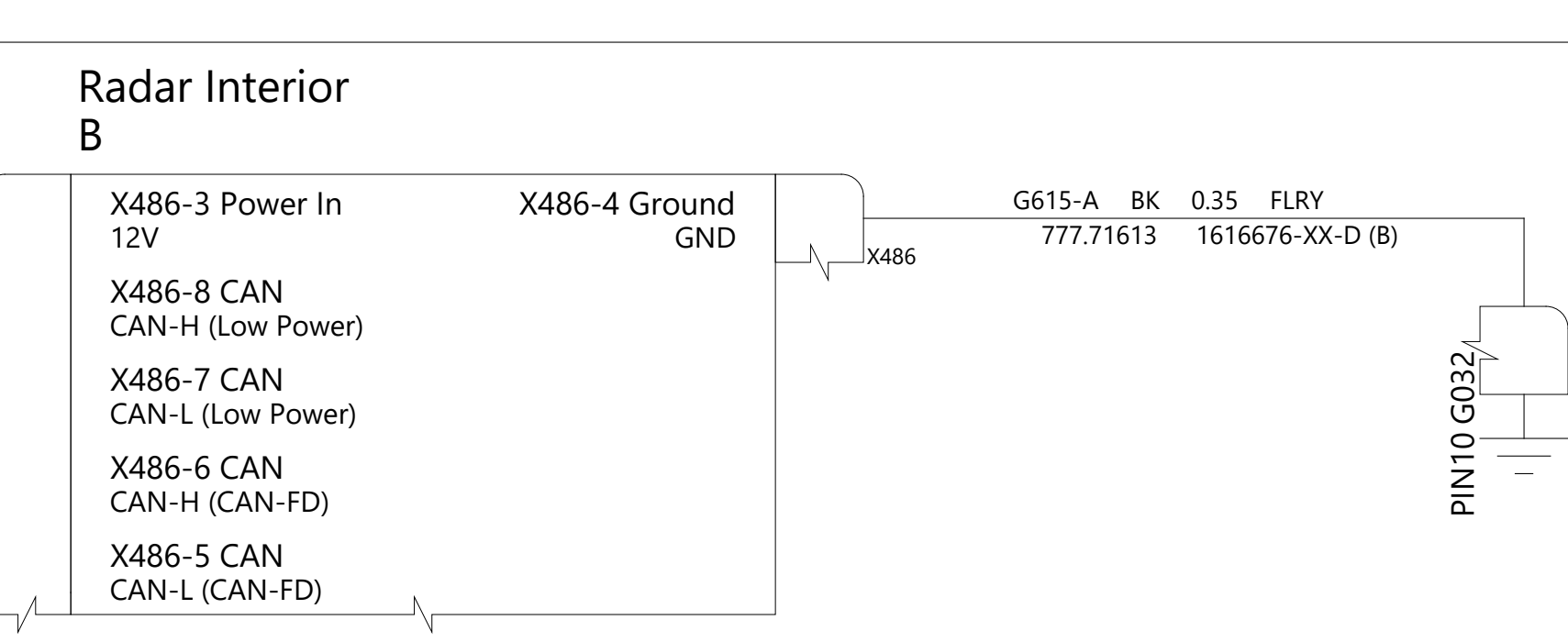
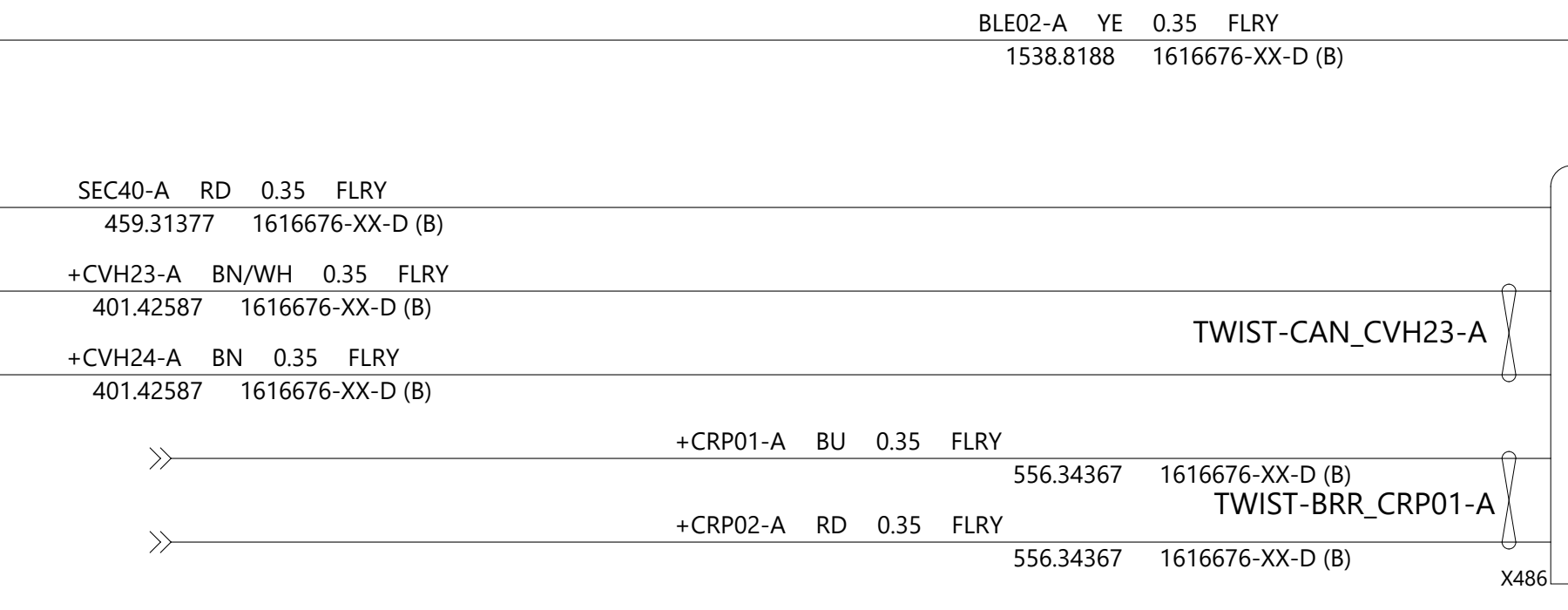
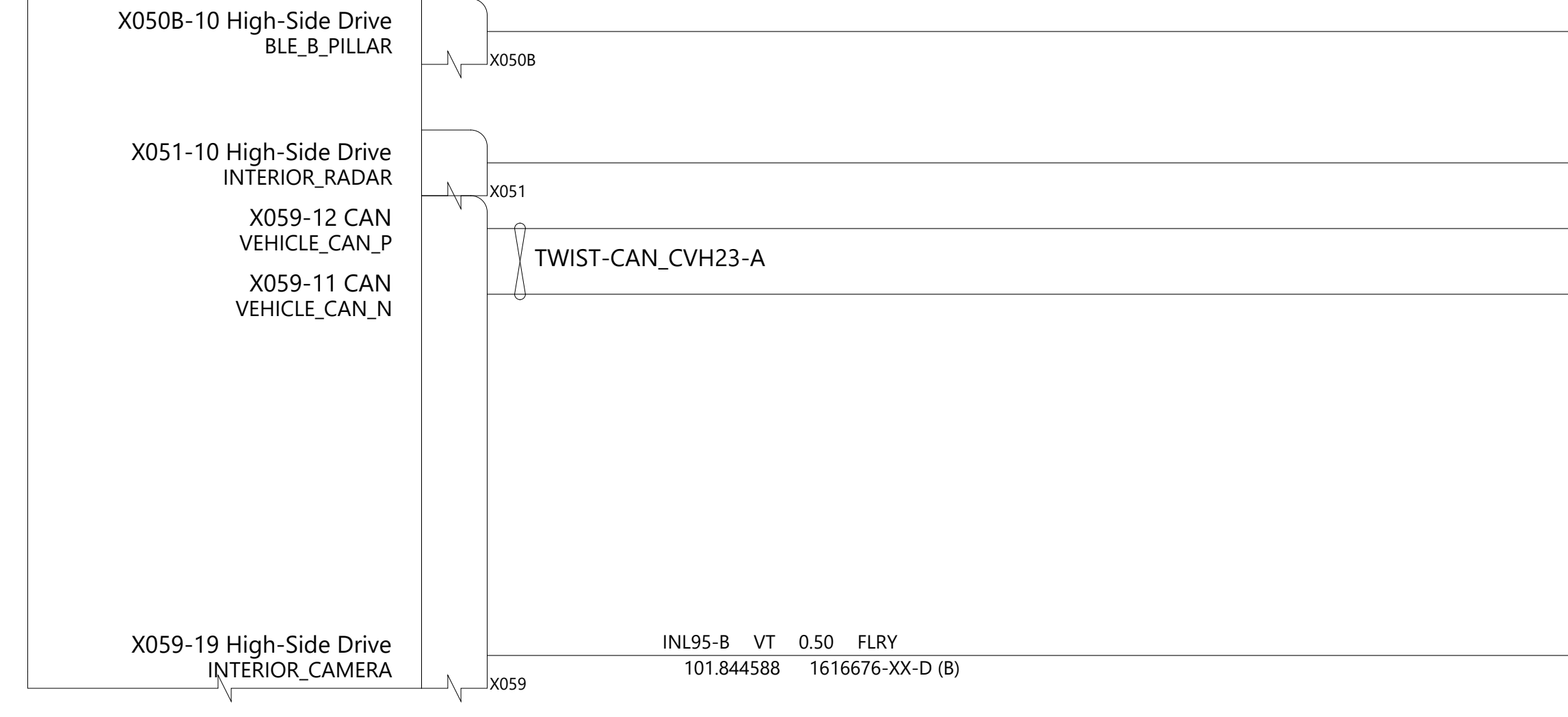

Interior Camera
V X127 X880

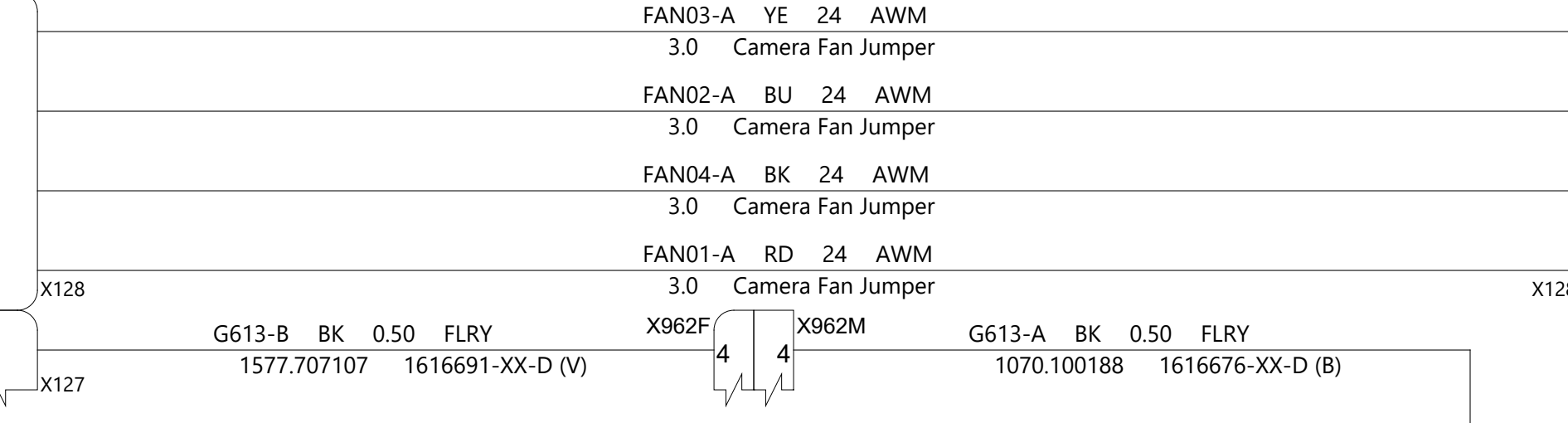
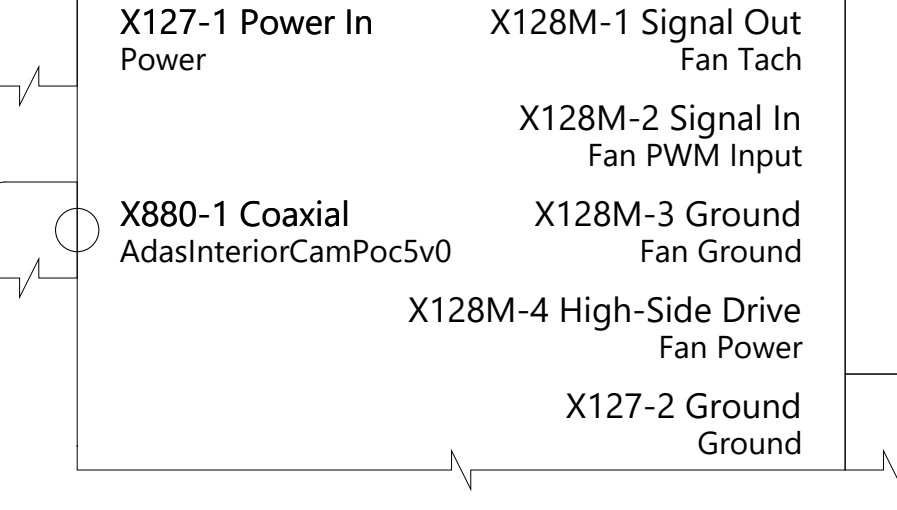

Interior Camera Fan
Fan Pigtail

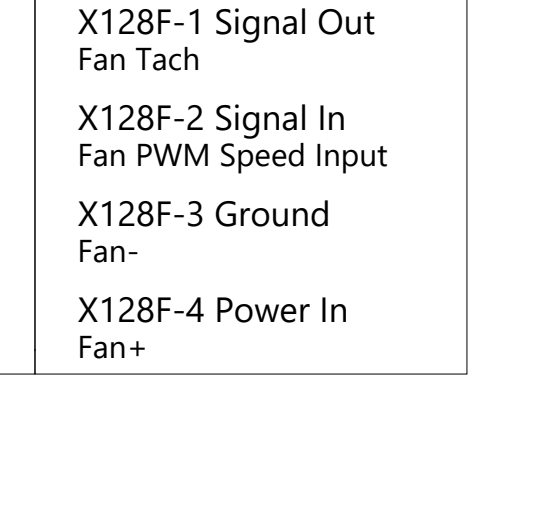

THE INFORMATION CONTAINED HEREIN IS DEEMED TO BE CONFIDENTIAL, PROPRIETARY, AND A TRADE SECRET OF TESLA MOTORS. THIS INFORMATION MAY NOT BE USED, REPRODUCED, OR DISCLOSED AS THE DIRECT OR INDIRECT BASIS FOR THE DEVELOPMENT, MANUFACTURE, OR SALE OF PROCESSES OR PRODUCTS WITHOUT THE EXPRESS WRITTEN CONSENT OF TESLA MOTORS.

DRAWN	CHECKED	APPROVED
-------	---------	----------

MATERIAL AS SPECIFIED	FINISHING AS SPECIFIED	SCALE NONE
--------------------------	---------------------------	---------------

PART NAME
Security Controls

PART NUMBER	REV	SHEET	SIZE
	1	51 OF 54	A0

Body Controller Front
W,U X021 X012 X011 X010 X015 X014

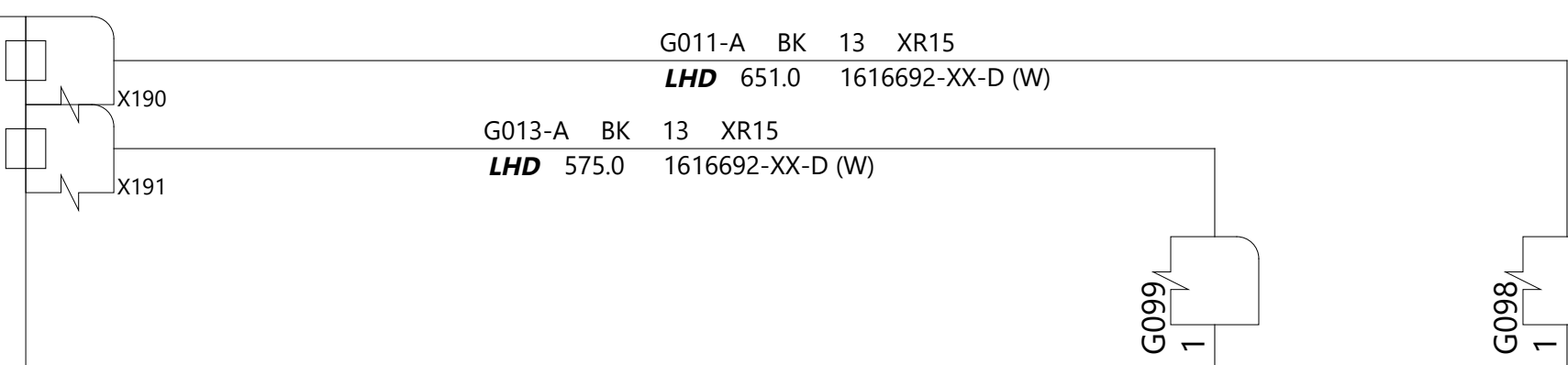
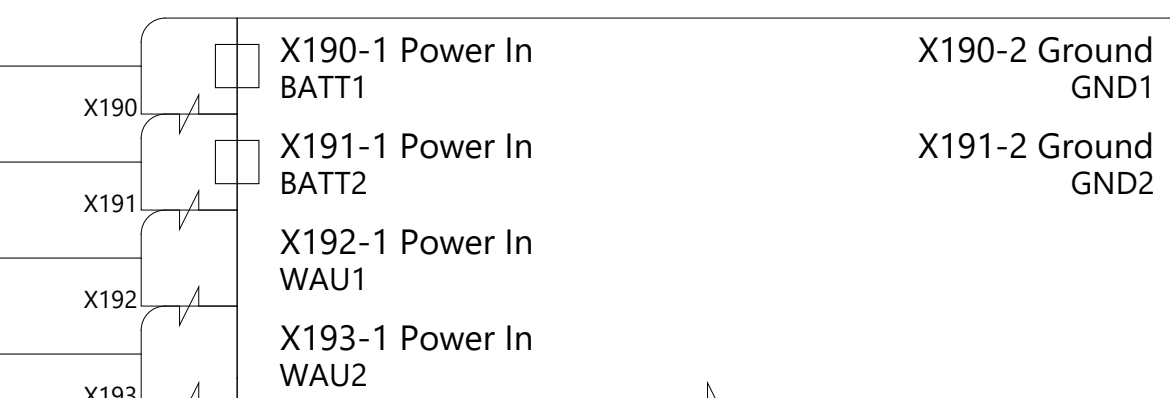
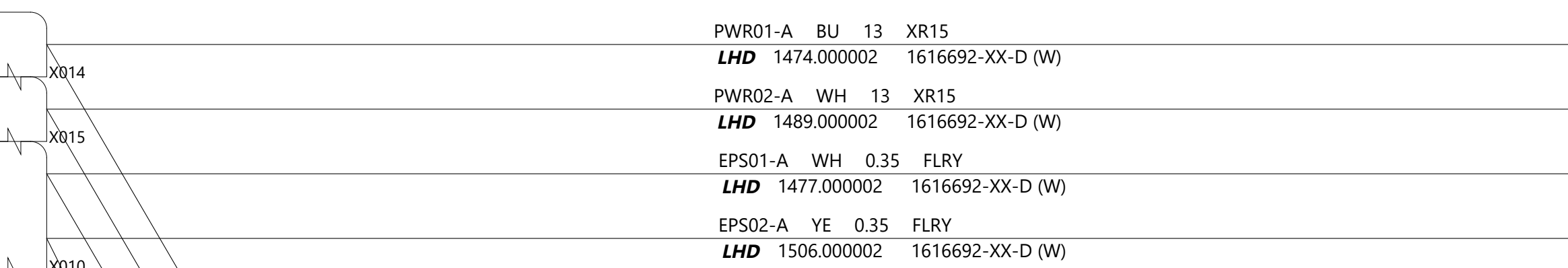
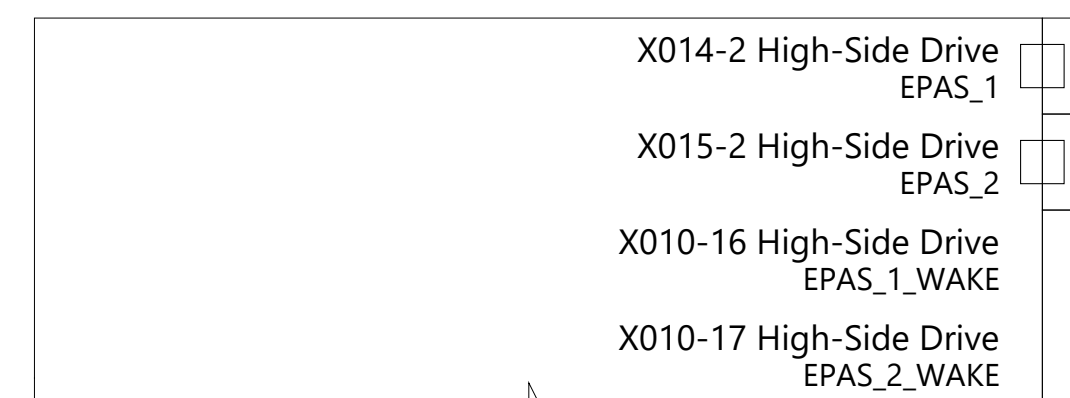

Body Controller Left
A,D,J,W X036 X030A X030B X031 X039 X037 X033A X033B X032 X035 X038

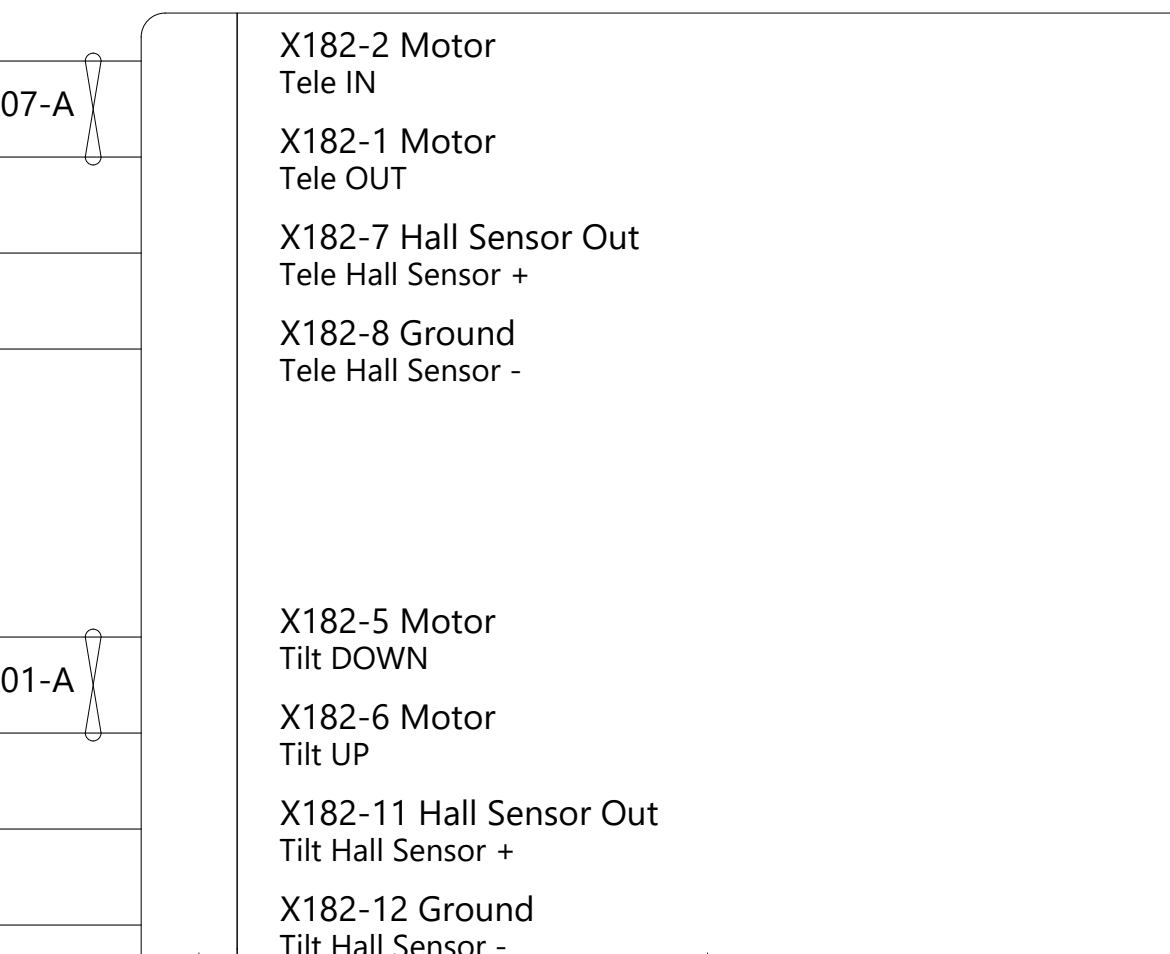
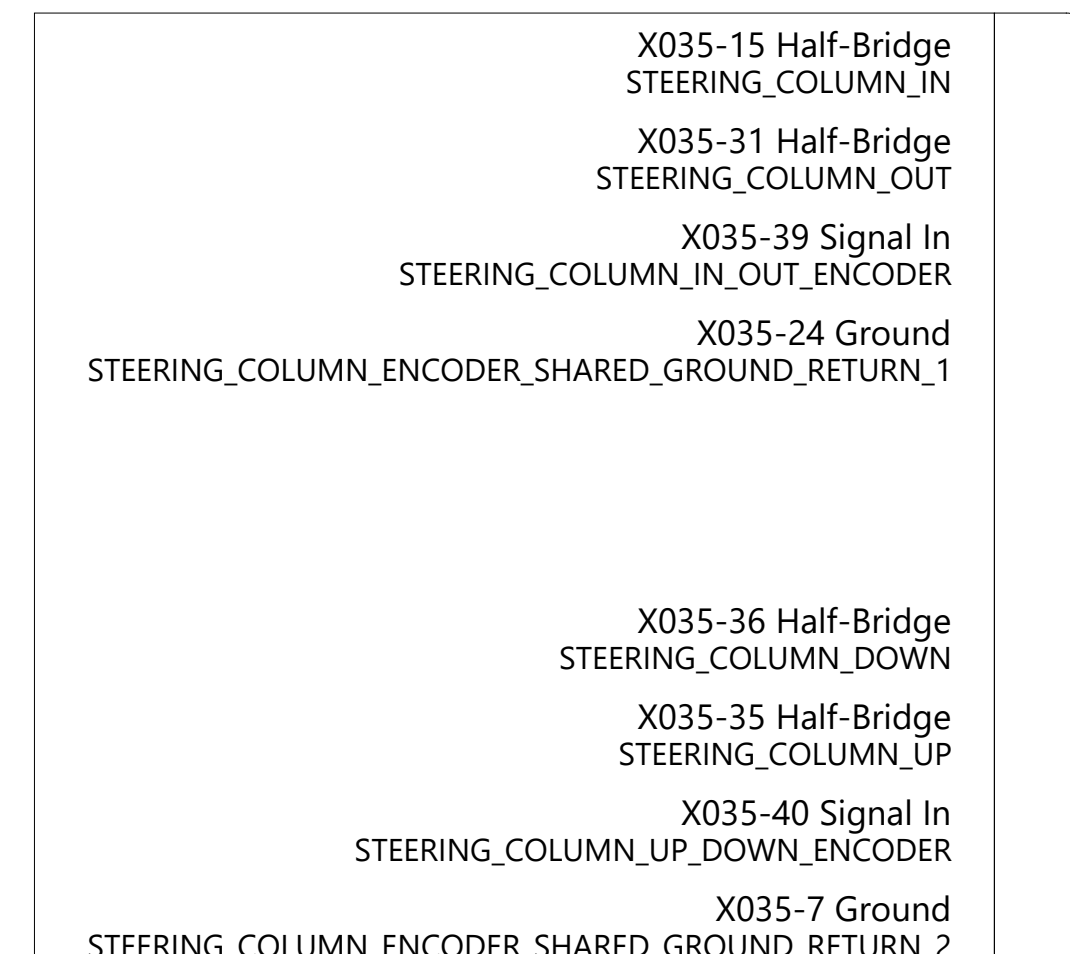

Steering Angle and Stalk ECU
J

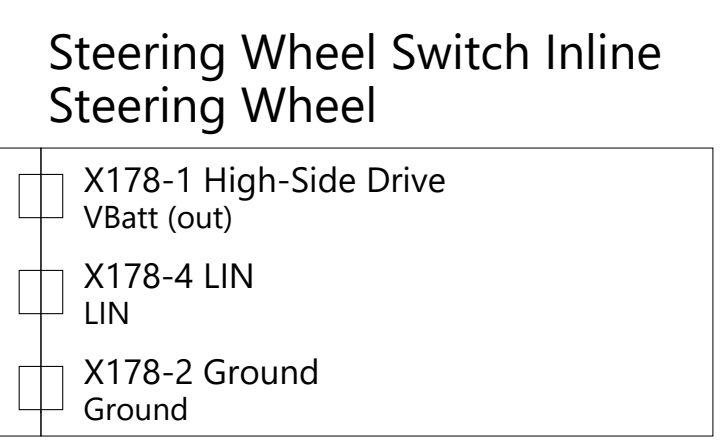
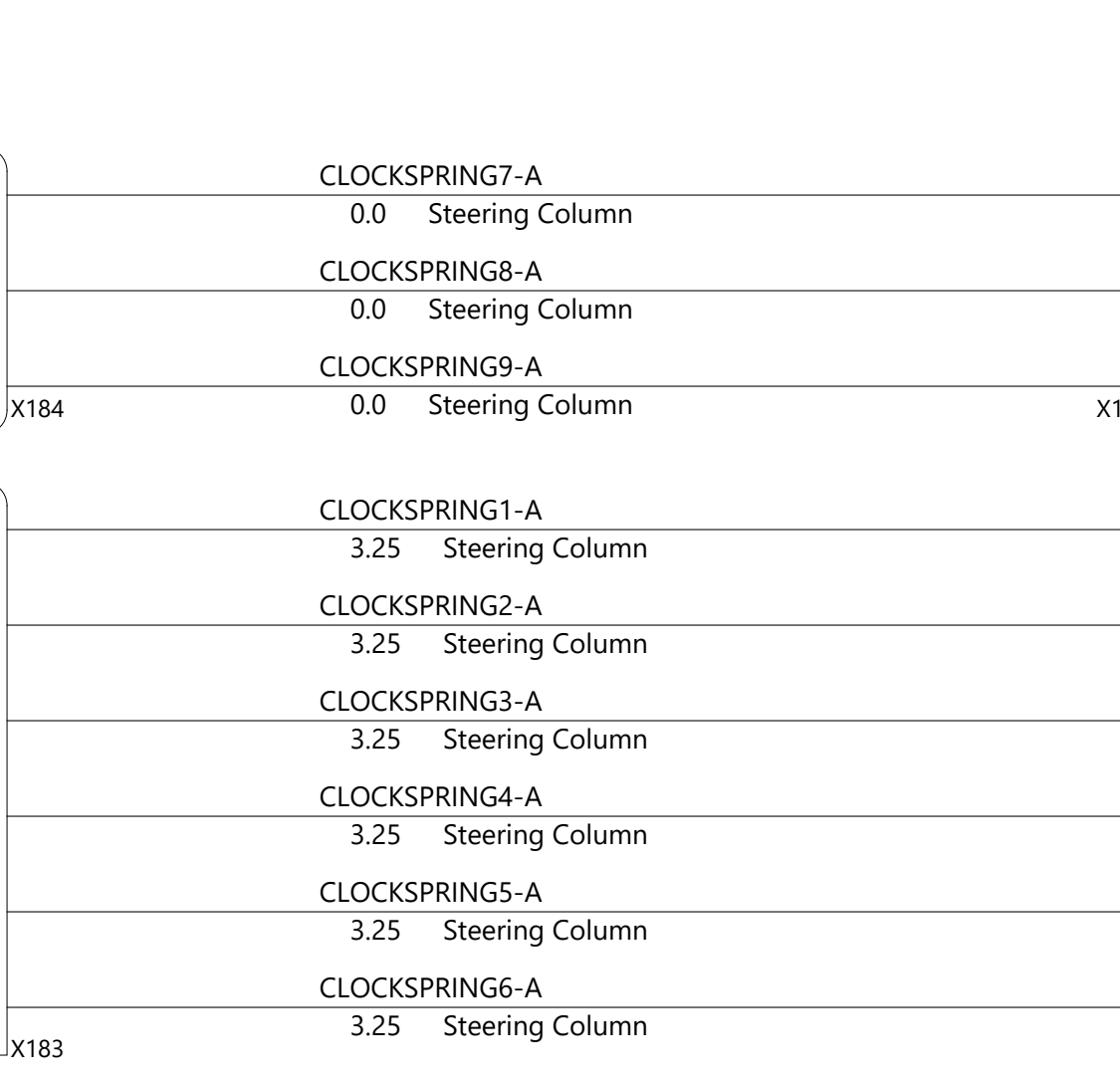
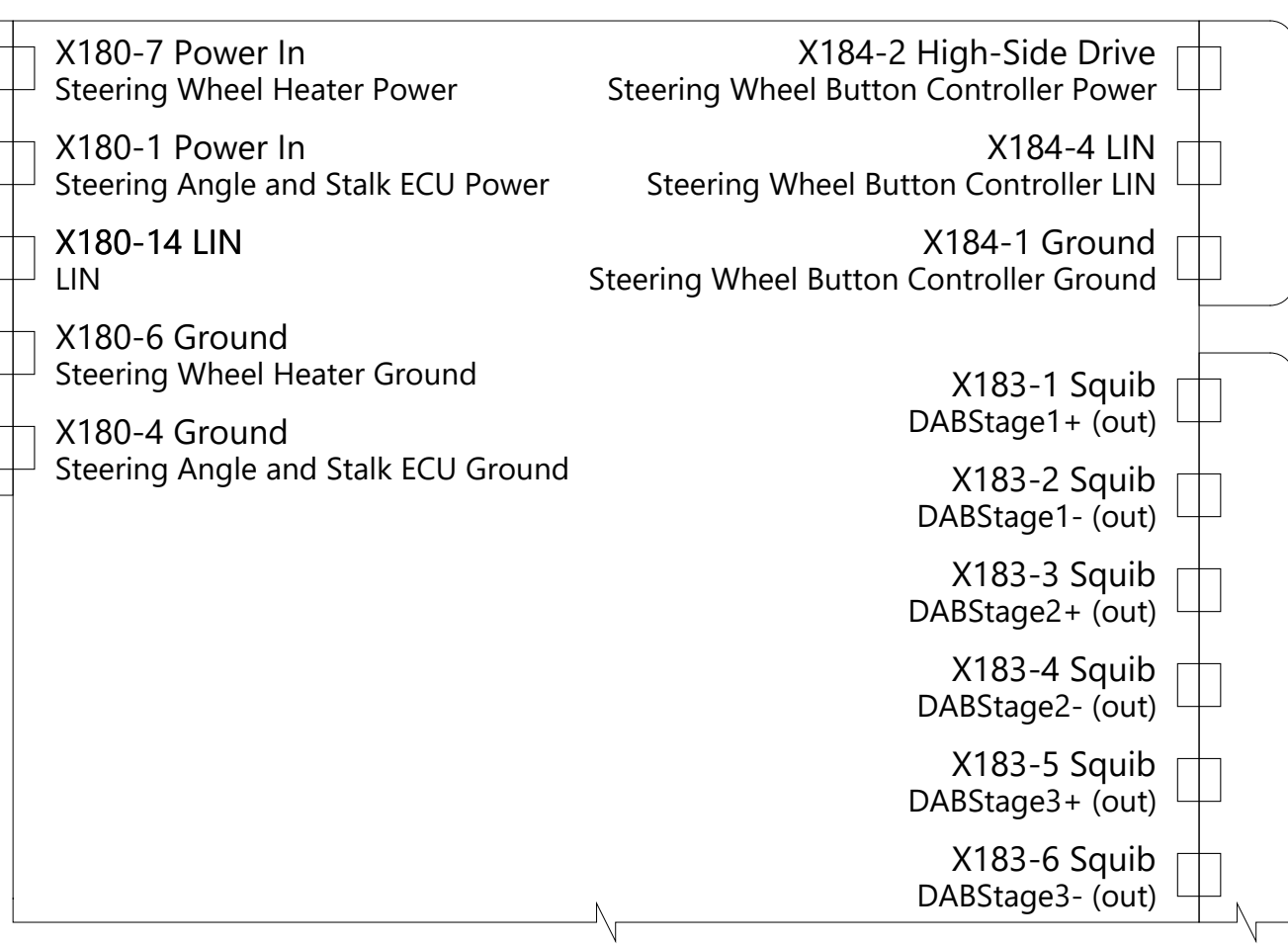

THE INFORMATION CONTAINED HEREIN IS DEEMED TO BE CONFIDENTIAL, PROPRIETARY, AND A TRADE SECRET OF TESLA MOTORS. THIS INFORMATION MAY NOT BE USED, REPRODUCED, OR DISCLOSED AS THE DIRECT OR INDIRECT BASIS FOR THE DEVELOPMENT, MANUFACTURE, OR SALE OF PROCESSES OR PRODUCTS WITHOUT THE EXPRESSED WRITTEN CONSENT OF TESLA MOTORS.

DRAWN	CHECKED	APPROVED
-------	---------	----------

MATERIAL AS SPECIFIED	FINISHING AS SPECIFIED	SCALE NONE
--------------------------	---------------------------	---------------

PART NAME
Steering

PART NUMBER	REV 1	SHEET 52 of 54	SIZE A0
-------------	----------	-------------------	------------

Body Controller Left
A,D,J,W X036 X030A X030B X031 X039 X037 X033A X033B X032 X035 X038

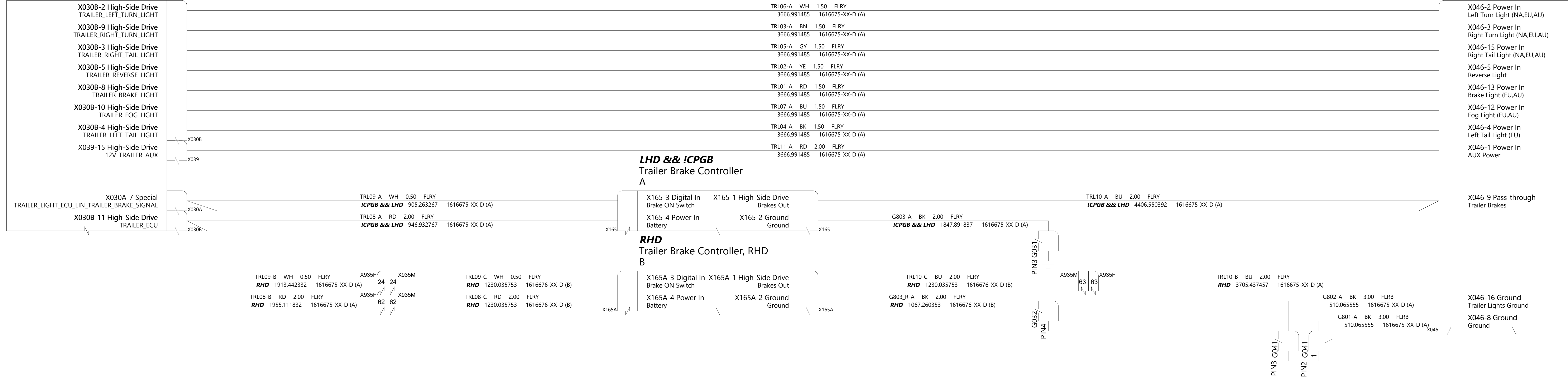

Trailer Inline to Vehicle
Z

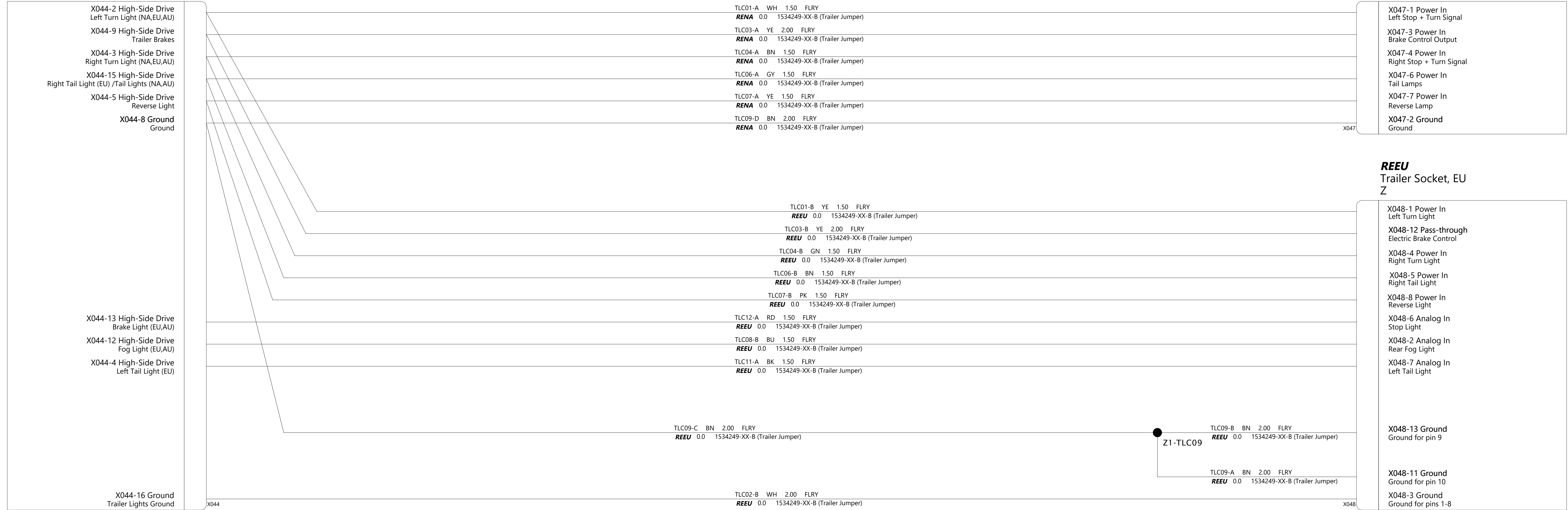

TESLA

THE INFORMATION CONTAINED HEREIN IS DEEMED TO BE CONFIDENTIAL, PROPRIETARY, AND A TRADE SECRET OF TESLA MOTORS. THIS INFORMATION MAY NOT BE USED, REPRODUCED, OR DISCLOSED AS THE DIRECT OR INDIRECT BASIS FOR THE DEVELOPMENT, MANUFACTURE, OR SALE OF PROCESSES OR PRODUCTS WITHOUT THE EXPRESSED WRITTEN CONSENT OF TESLA MOTORS.

DRAWN	CHECKED	APPROVED
MATERIAL AS SPECIFIED	FINISHING AS SPECIFIED	SCALE NONE
PART NAME Towing		
PART NUMBER	REV	SHEET
	1	53 of 54
		SCALE A0

Body Controller Right
B,P,J,W X056 X056 X050A X050B X051 X059 X057 X053A X053B X052 X055 X058 X060

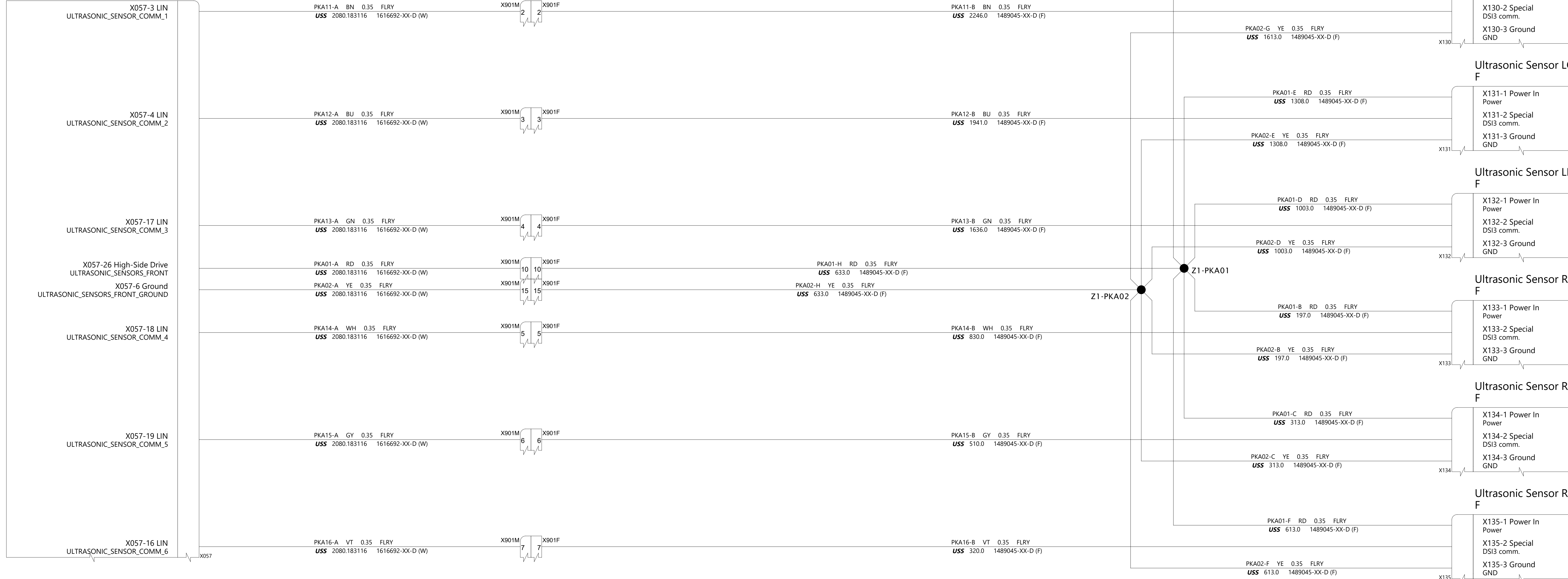

Body Controller Right
B,P,J,W X056 X056 X050A X050B X051 X059 X057 X053A X053B X052 X055 X058 X060

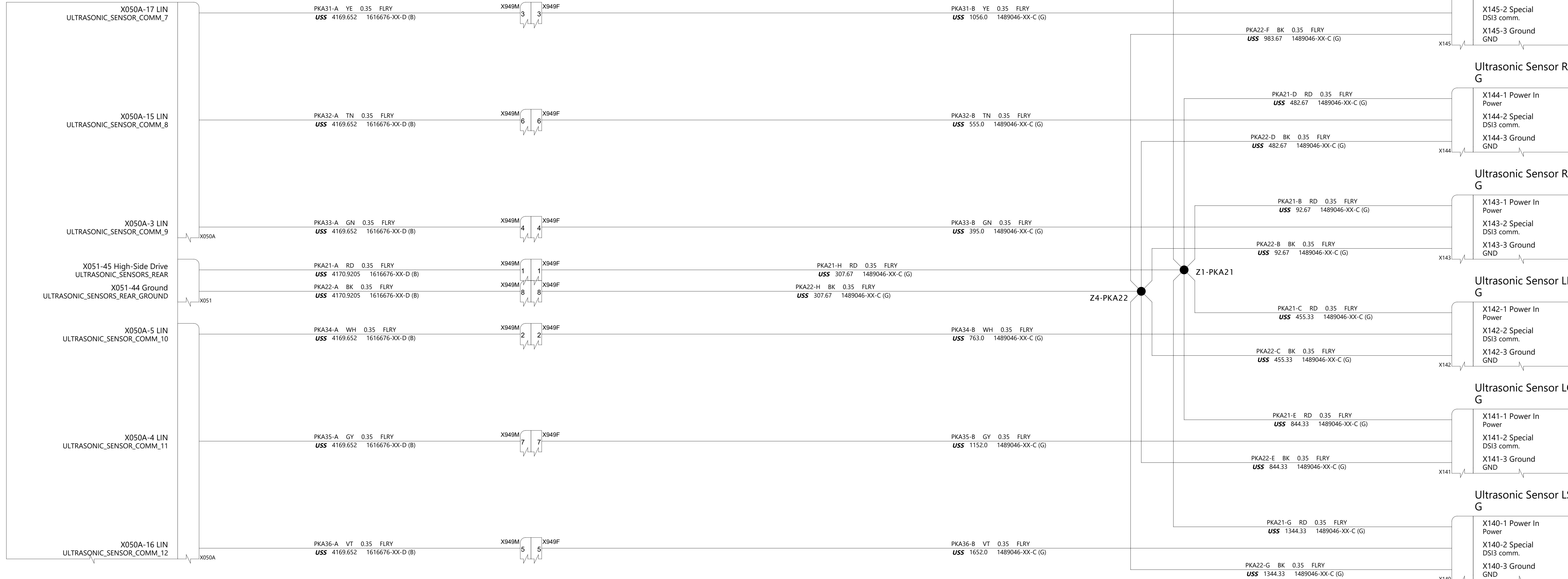

THE INFORMATION CONTAINED HEREIN IS DEEMED TO BE CONFIDENTIAL, PROPRIETARY, AND A TRADE SECRET OF TESLA MOTORS. THIS INFORMATION MAY NOT BE USED, REPRODUCED, OR DISCLOSED AS THE DIRECT OR INDIRECT BASIS FOR THE DEVELOPMENT, MANUFACTURE, OR SALE OF PROCESSES OR PRODUCTS WITHOUT THE EXPRESSED WRITTEN CONSENT OF TESLA MOTORS.

DRAWN	CHECKED	APPROVED

MATERIAL AS SPECIFIED	FINISHING AS SPECIFIED	SCALE NONE

PART NAME
Ultrasonics

PART NUMBER	REV	SHEET	SIZE
	1	54 OF 54	A0