

Left Controller

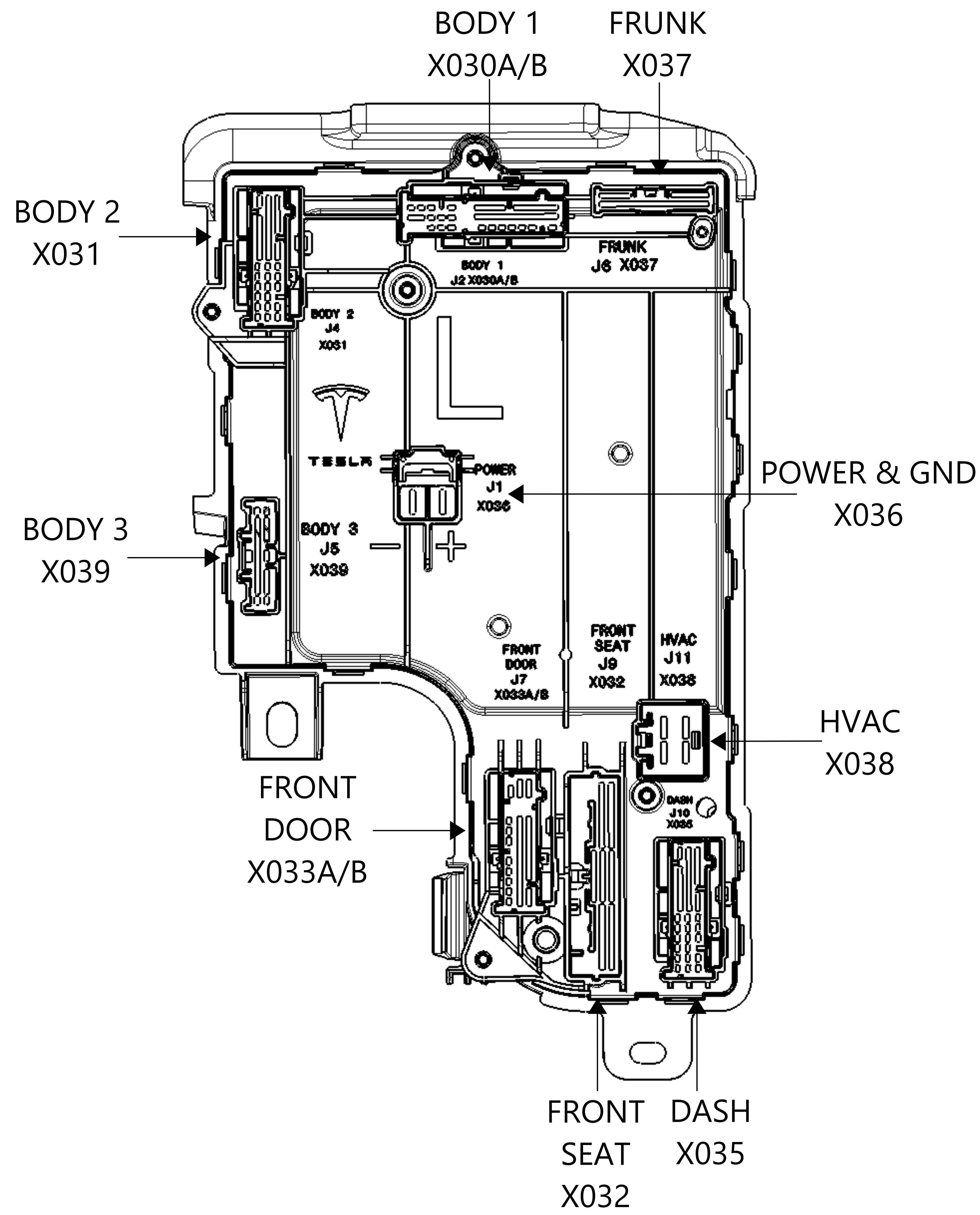

Front Controller

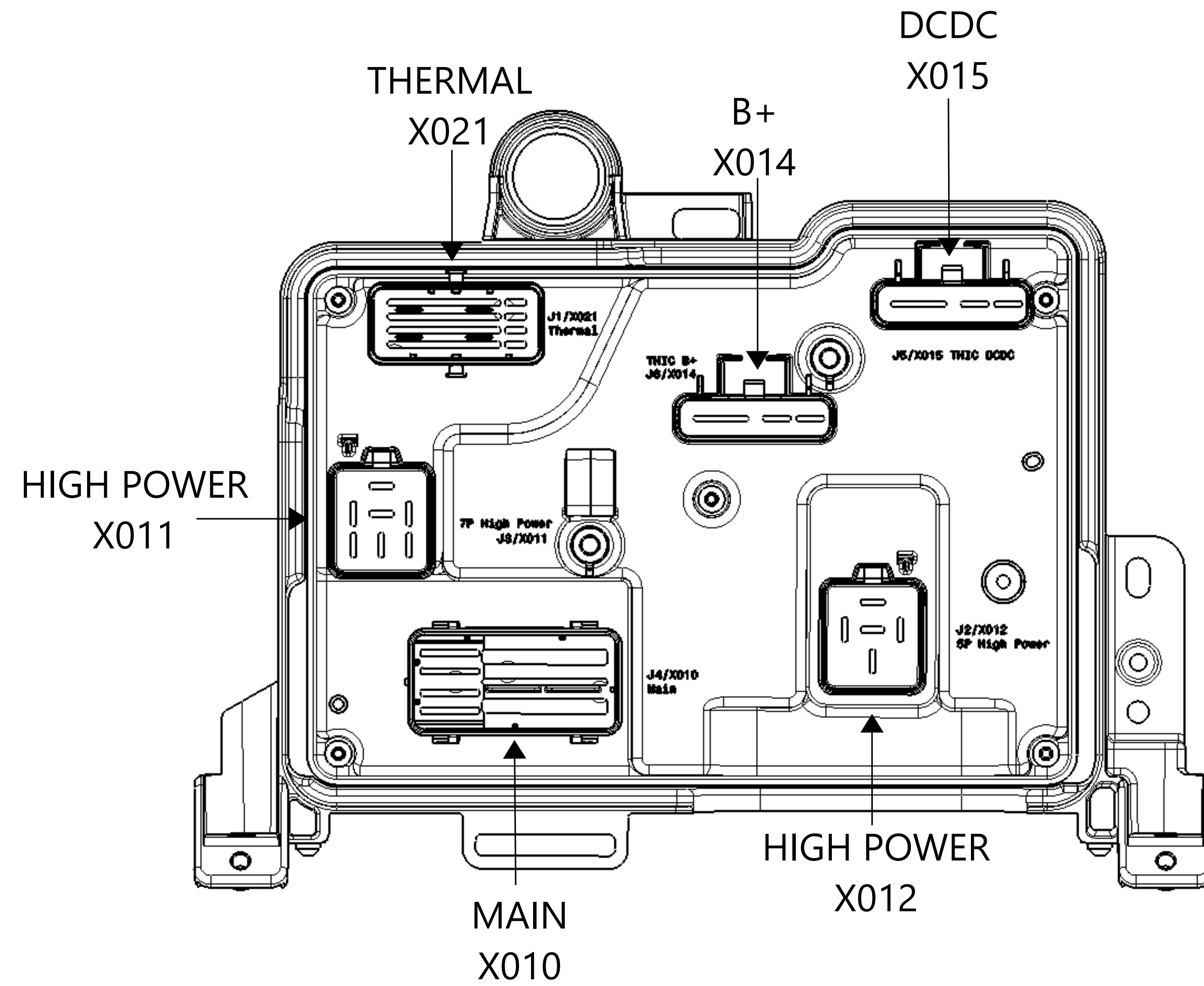

Right Controller

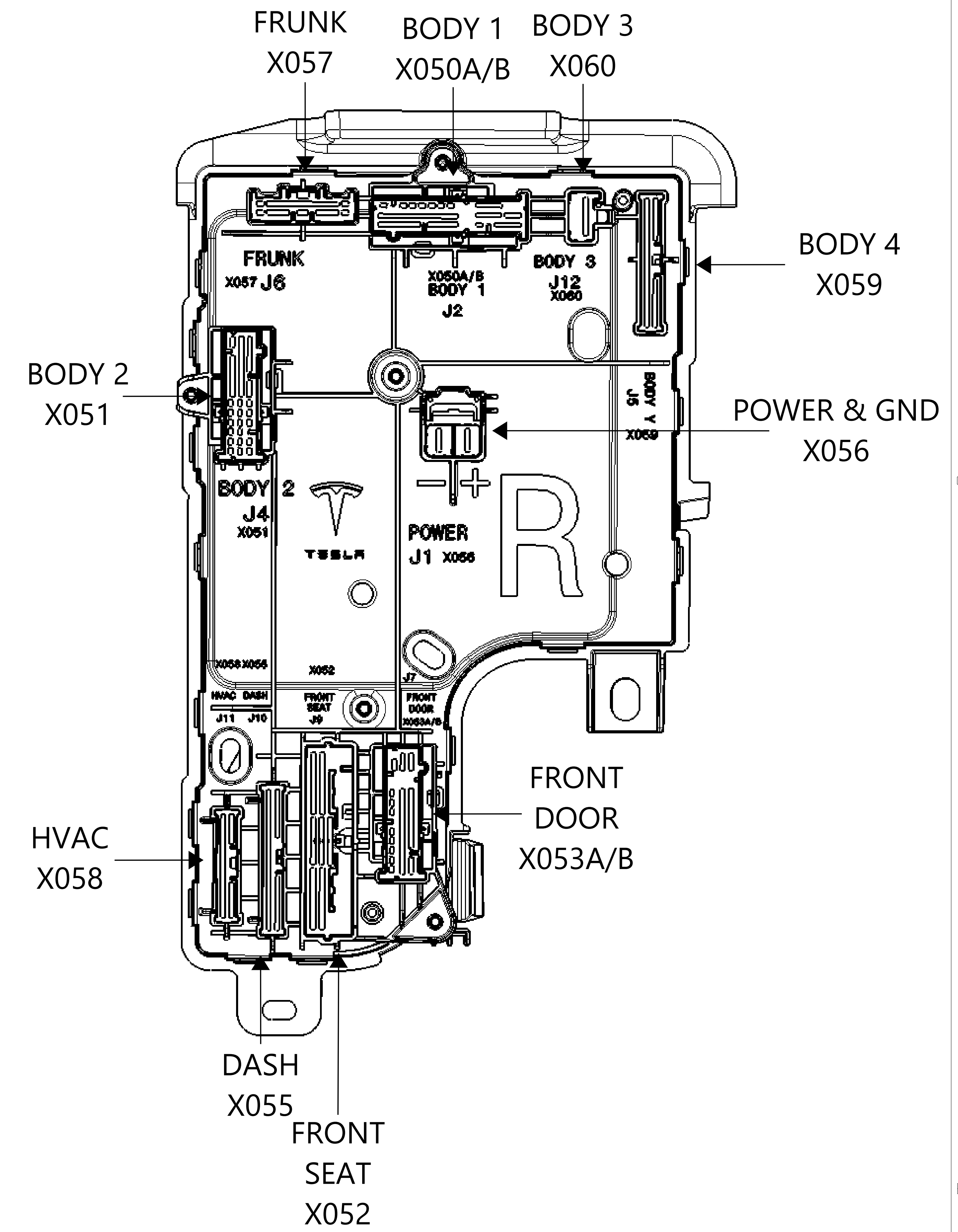

TESLA

THE INFORMATION CONTAINED HEREIN IS DEEMED TO BE CONFIDENTIAL, PROPRIETARY, AND A TRADE SECRET OF TESLA MOTORS. THIS INFORMATION MAY NOT BE USED, REPRODUCED, OR DISCLOSED AS THE DIRECT OR INDIRECT BASIS FOR THE DEVELOPMENT, MANUFACTURE, OR SALE OF PROCESSES OR PRODUCTS WITHOUT THE EXPRESS WRITTEN CONSENT OF TESLA MOTORS.

DRAWN	CHECKED	APPROVED
MATERIAL AS SPECIFIED	FINISHING AS SPECIFIED	SCALE NONE
PART NAME 2. Controller Layout		
PART NUMBER	REV	SHEET
	1	2 OF 54
		SIZE A0

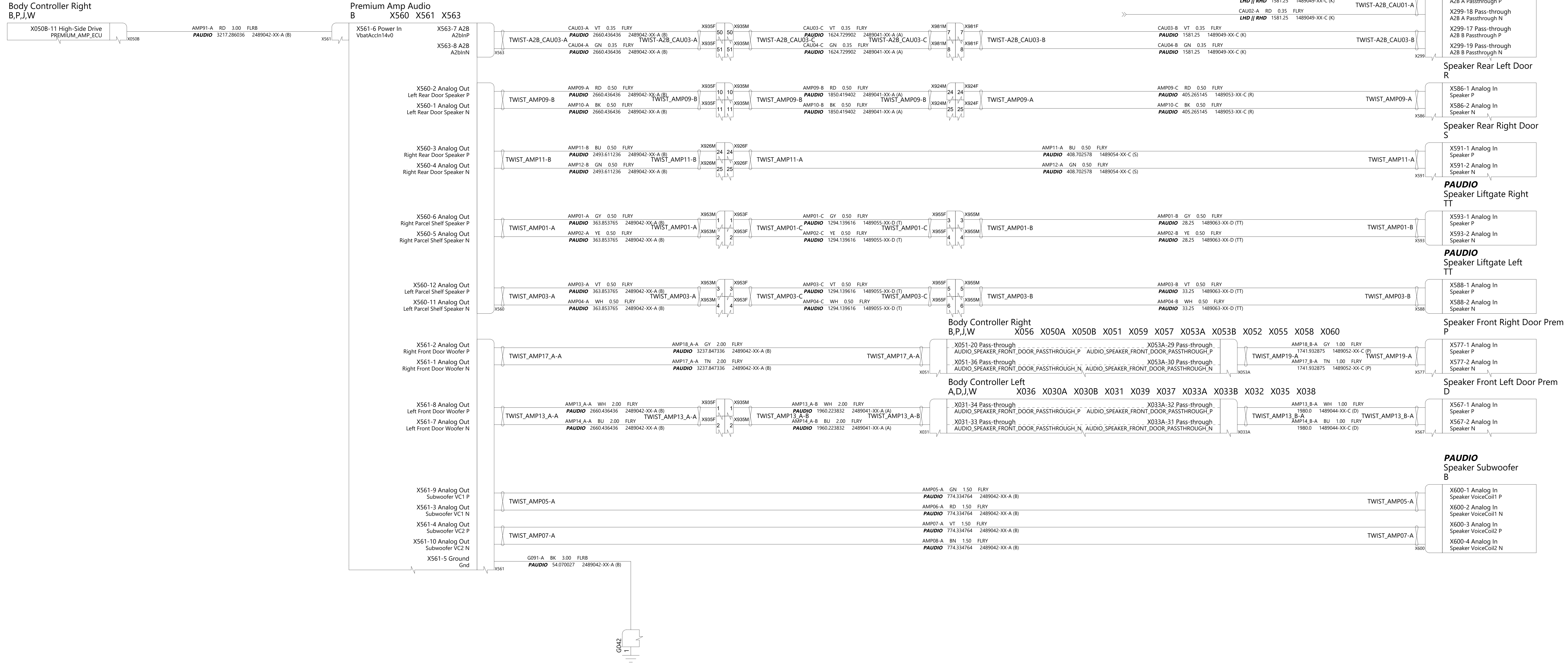

THE INFORMATION CONTAINED HEREIN IS DEEMED TO BE CONFIDENTIAL, PROPRIETARY, AND A TRADE SECRET OF TESLA MOTORS. THIS INFORMATION MAY NOT BE USED, REPRODUCED, OR DISCLOSED AS THE DIRECT OR INDIRECT BASIS FOR THE DEVELOPMENT, MANUFACTURE, OR SALE OF PROCESSES OR PRODUCTS WITHOUT THE EXPRESSED WRITTEN CONSENT OF TESLA MOTORS.

DRAWN	CHECKED	APPROVED
-------	---------	----------

MATERIAL AS SPECIFIED	FINISHING AS SPECIFIED	SCALE NONE
--------------------------	---------------------------	---------------

PART NAME
Audio, Premium Amp

PART NUMBER	REV	SHEET	SCALE
	1	4 OF 54	A0

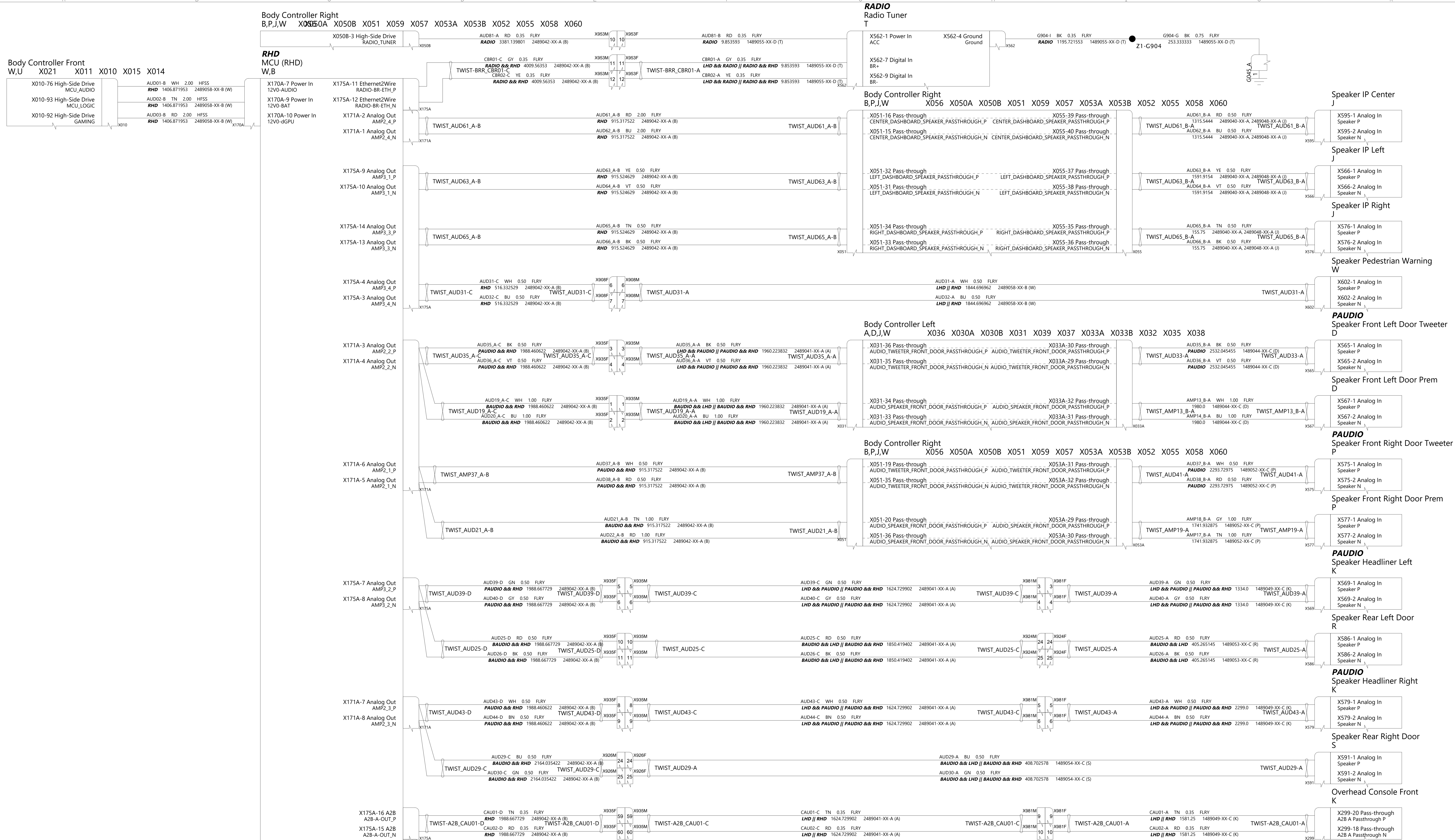

THE INFORMATION CONTAINED HEREIN IS DEEMED TO BE CONFIDENTIAL, PROPRIETARY, AND A TRADE SECRET OF TESLA MOTORS. THIS INFORMATION MAY NOT BE USED, REPRODUCED, OR DISCLOSED AS THE DIRECT OR INDIRECT BASIS FOR THE DEVELOPMENT, MANUFACTURE, OR SALE OF PROCESSES OR PRODUCTS WITHOUT THE EXPRESSED WRITTEN CONSENT OF TESLA MOTORS.

DRAWN	CHECKED	APPROVED

MATERIAL AS SPECIFIED	FINISHING AS SPECIFIED	SCALE NONE

PART NAME
Audio, RHD

PART NUMBER	REV	SHEET	SIZE
	1	5 of 54	A0

Body Controller Left
A,D,J,W X036 X030A X030B X031 X039 X037 X033A X033B X032 X035 X038

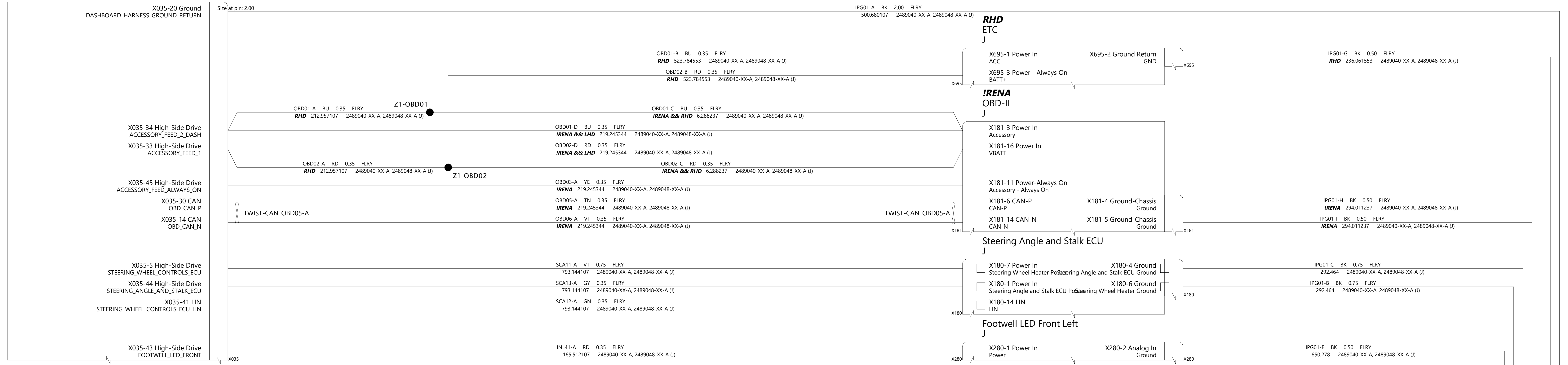

Body Controller Right
B,P,J,W X056 X050A X050B X051 X059 X057 X053A X053B X052 X055 X058 X060

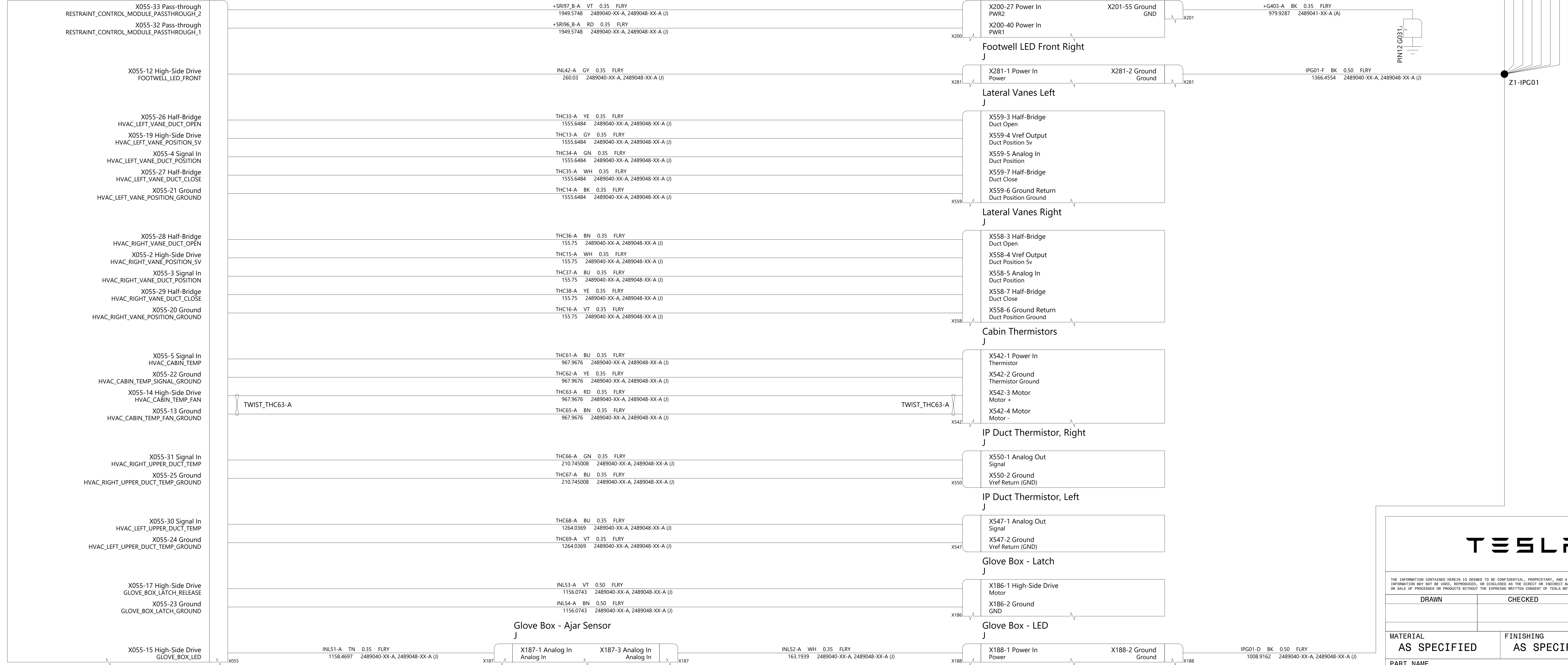

TESLA

THE INFORMATION CONTAINED HEREIN IS DEEMED TO BE CONFIDENTIAL, PROPRIETARY, AND A TRADE SECRET OF TESLA MOTORS. THIS INFORMATION MAY NOT BE USED, REPRODUCED, OR DISCLOSED AS THE DIRECT OR INDIRECT BASIS FOR THE DEVELOPMENT, MANUFACTURE, OR SALE OF PROCESSES OR PRODUCTS WITHOUT THE EXPRESSED WRITTEN CONSENT OF TESLA MOTORS.

DRAWN	CHECKED	APPROVED		
MATERIAL AS SPECIFIED	FINISHING AS SPECIFIED	SCALE NONE		
PART NAME Body Controllers Dashboard				
PART NUMBER	REV	SHEET	SCALE	SIZE
	1	7 OF 54		A0

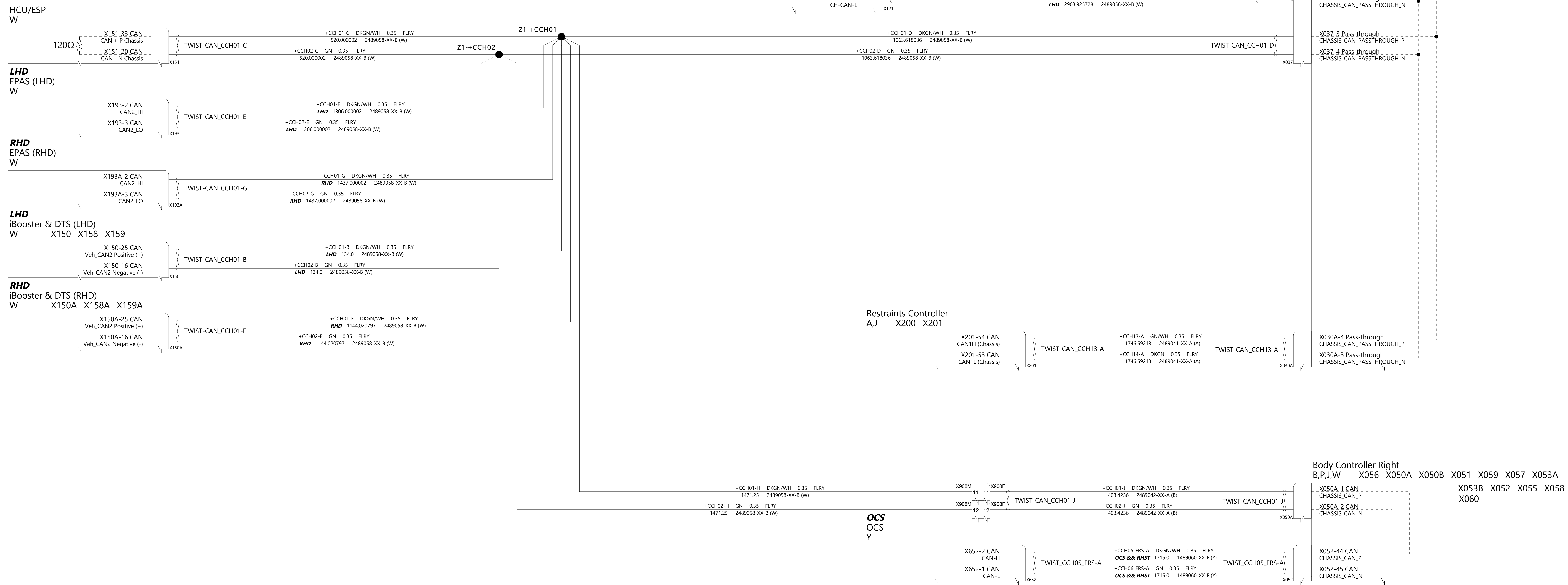

THE INFORMATION CONTAINED HEREIN IS DEEMED TO BE CONFIDENTIAL, PROPRIETARY, AND A TRADE SECRET OF TESLA MOTORS. THIS INFORMATION MAY NOT BE USED, REPRODUCED, OR DISCLOSED AS THE DIRECT OR INDIRECT BASIS FOR THE DEVELOPMENT, MANUFACTURE, OR SALE OF PROCESSES OR PRODUCTS WITHOUT THE EXPRESS WRITTEN CONSENT OF TESLA MOTORS.

DRAWN	CHECKED	APPROVED
-------	---------	----------

MATERIAL AS SPECIFIED	FINISHING AS SPECIFIED	SCALE NONE
-----------------------	------------------------	------------

PART NAME
CAN Chassis

PART NUMBER	REV	SHEET	SIZE
	1	9 OF 54	A0

Body Controller Front
W,U X021 X012 X011 X010 X015 X014

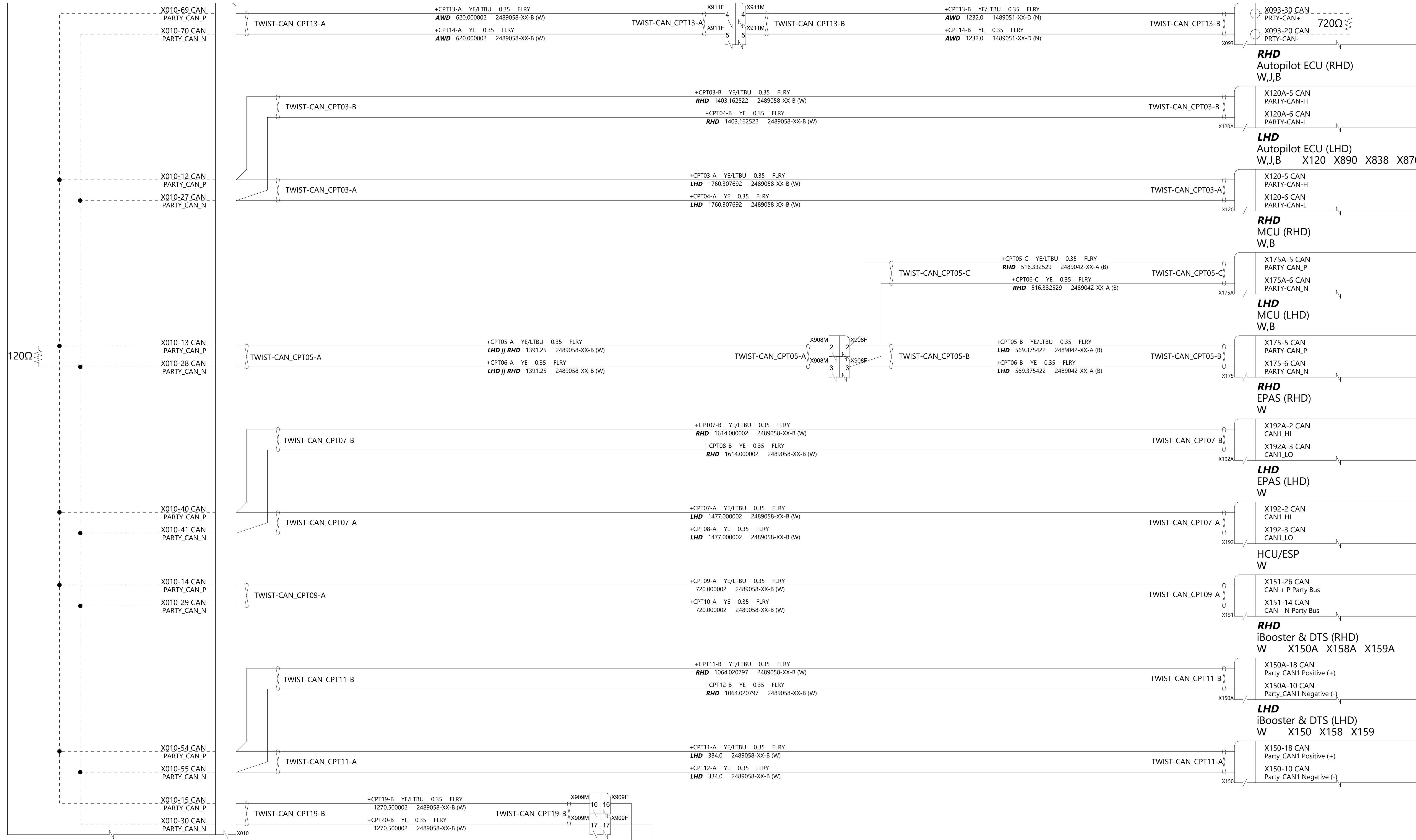

Body Controller Left
A,D,J,W X036 X030A X030B X031 X039 X037 X033A X033B X032 X035 X038

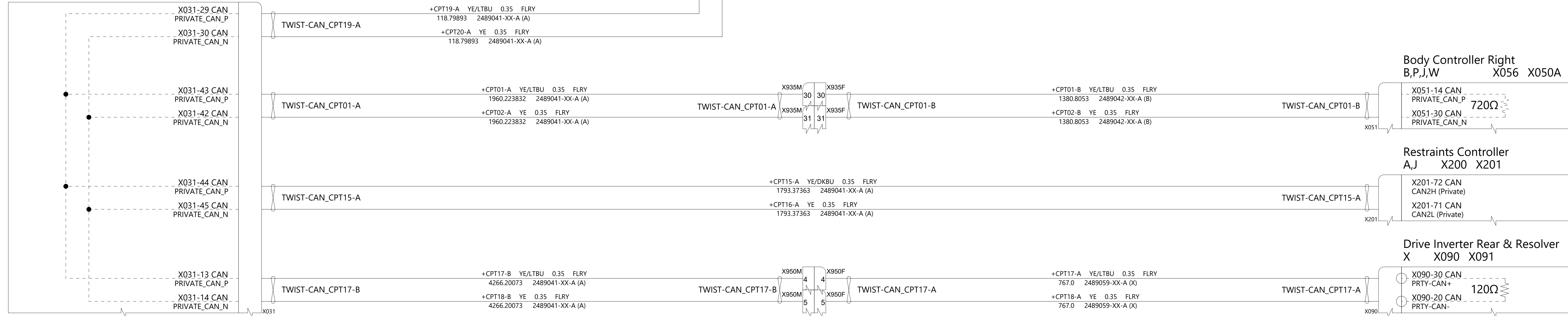

TESLA

THE INFORMATION CONTAINED HEREIN IS DEEMED TO BE CONFIDENTIAL, PROPRIETARY, AND A TRADE SECRET OF TESLA MOTORS. THIS INFORMATION MAY NOT BE USED, REPRODUCED, OR DISCLOSED AS THE DIRECT OR INDIRECT BASIS FOR THE DEVELOPMENT, MANUFACTURE, OR SALE OF PROCESSES OR PRODUCTS WITHOUT THE EXPRESSED WRITTEN CONSENT OF TESLA MOTORS.

DRAWN	CHECKED	APPROVED
MATERIAL AS SPECIFIED	FINISHING AS SPECIFIED	SCALE NONE
PART NAME CAN Party		
PART NUMBER	REV	SHEET
	1	10 of 54
		SIZE A0

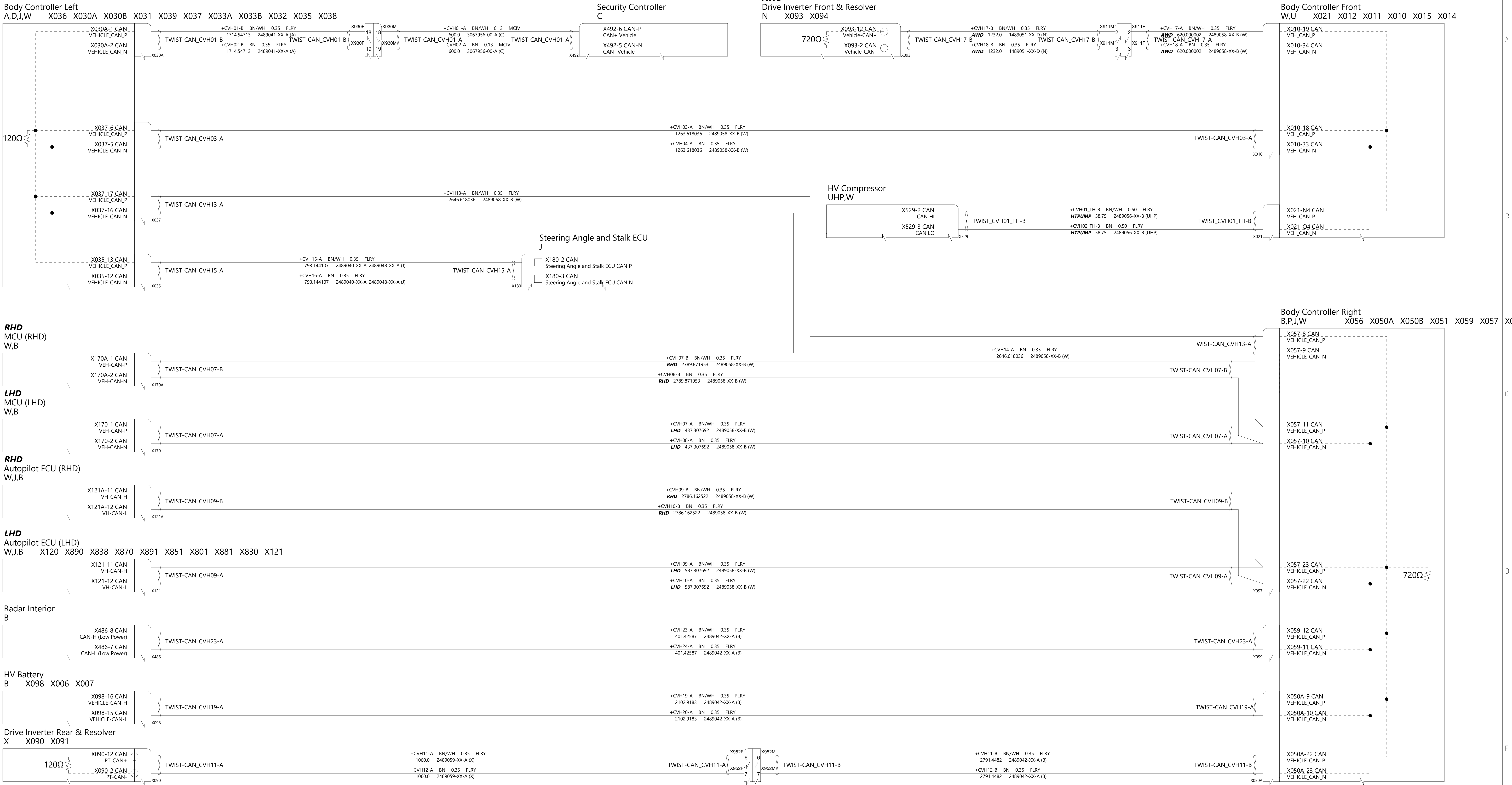

TESLA

THE INFORMATION CONTAINED HEREIN IS DEEMED TO BE CONFIDENTIAL, PROPRIETARY, AND A TRADE SECRET OF TESLA MOTORS. THIS INFORMATION MAY NOT BE USED, REPRODUCED, OR DISCLOSED AS THE OBJECT OR INSTRUMENT BASIS FOR THE DEVELOPMENT, MANUFACTURE, OR SALE OF PROCESSES OR PRODUCTS WITHOUT THE EXPRESSED WRITTEN CONSENT OF TESLA MOTORS.

DRAWN	CHECKED	APPROVED
MATERIAL AS SPECIFIED	FINISHING AS SPECIFIED	SCALE NONE
PART NAME CAN Vehicle		
PART NUMBER	REV	SHEET
	1	11 OF 54
		SIZE A0

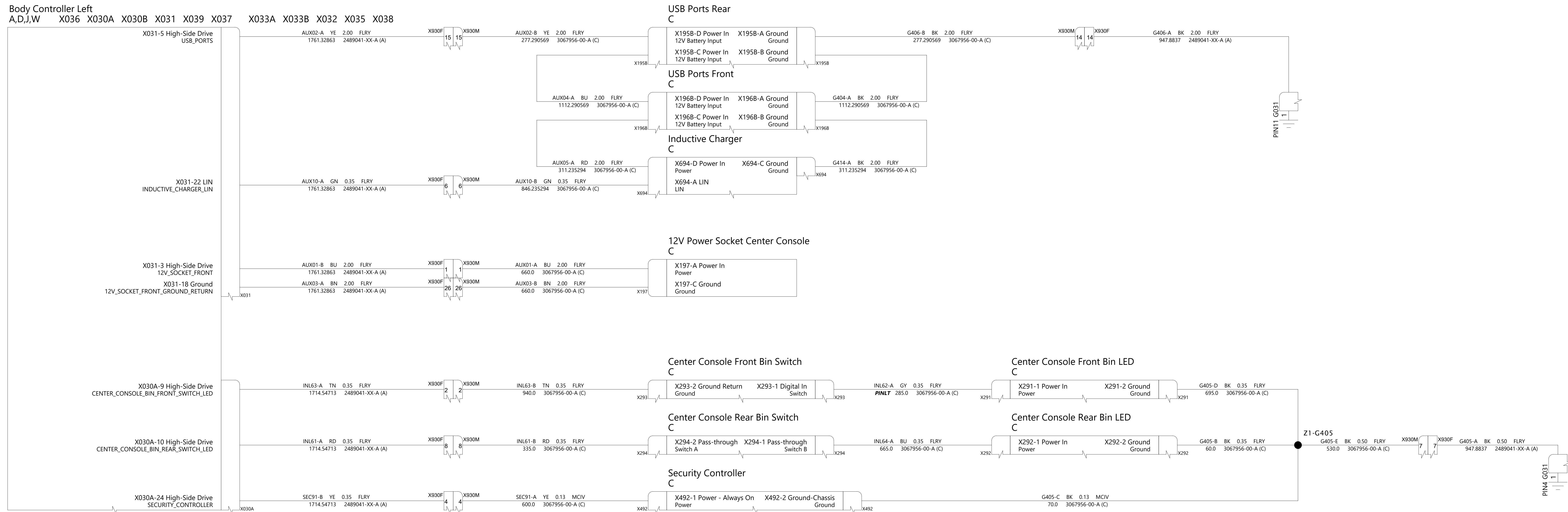

TESLA

THE INFORMATION CONTAINED HEREIN IS DEEMED TO BE CONFIDENTIAL, PROPRIETARY, AND A TRADE SECRET OF TESLA MOTORS. THIS INFORMATION MAY NOT BE USED, REPRODUCED, OR DISCLOSED AS THE DIRECT OR INDIRECT BASIS FOR THE DEVELOPMENT, MANUFACTURE, OR SALE OF PROCESSES OR PRODUCTS WITHOUT THE EXPRESSED WRITTEN CONSENT OF TESLA MOTORS.

DRAWN	CHECKED	APPROVED

MATERIAL AS SPECIFIED	FINISHING AS SPECIFIED	SCALE NONE
--------------------------	---------------------------	---------------

PART NAME
Center Console

PART NUMBER	REV	SHEET	SIZE
	1	12 of 54	A0

Body Controller Left
A,D,J,W X036 X030A X030B X031 X039 X037 X033A X033B X032 X035 X038

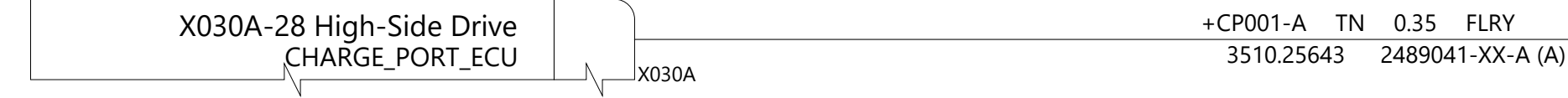

Charge Port ECU
A X096 X688 X687

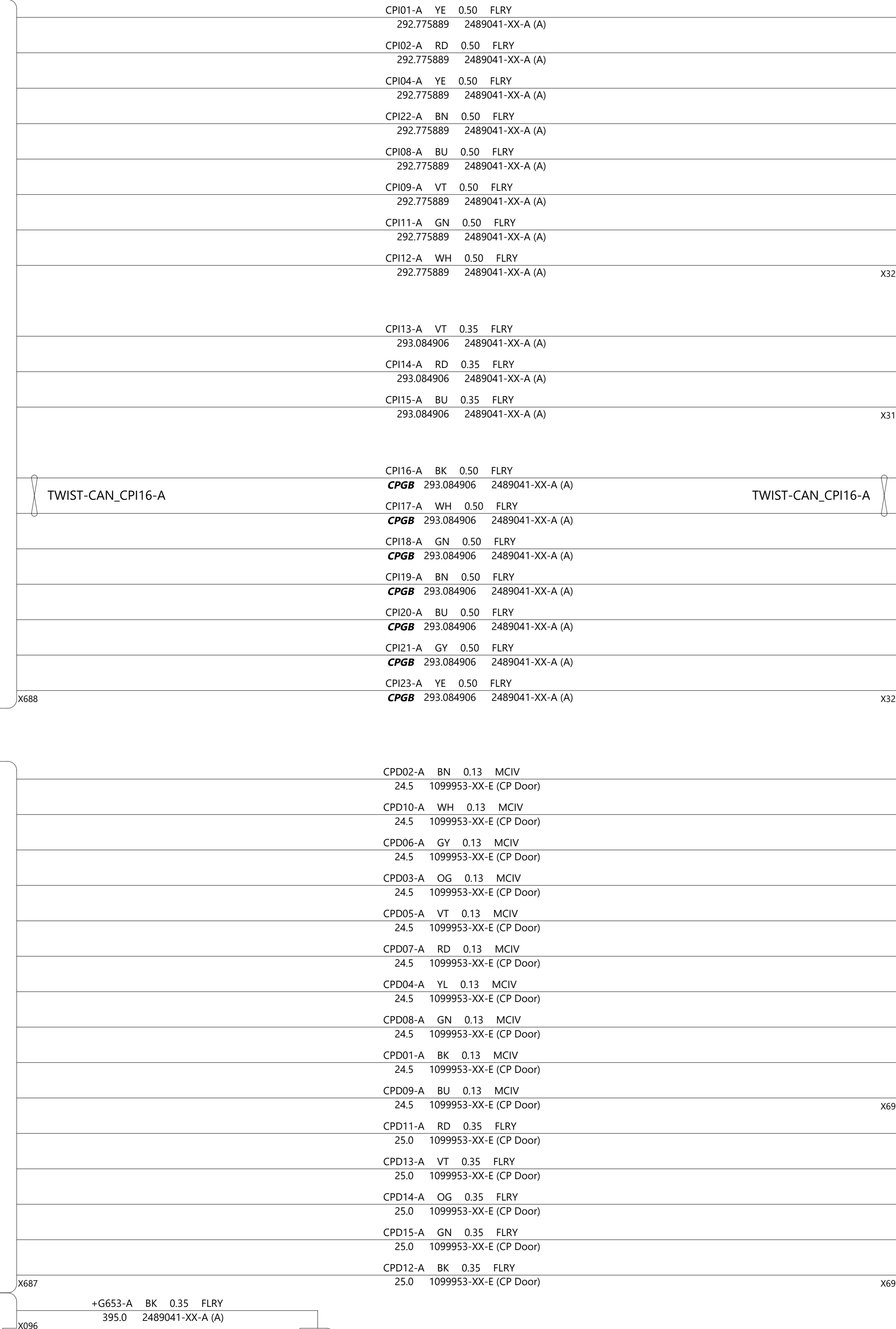
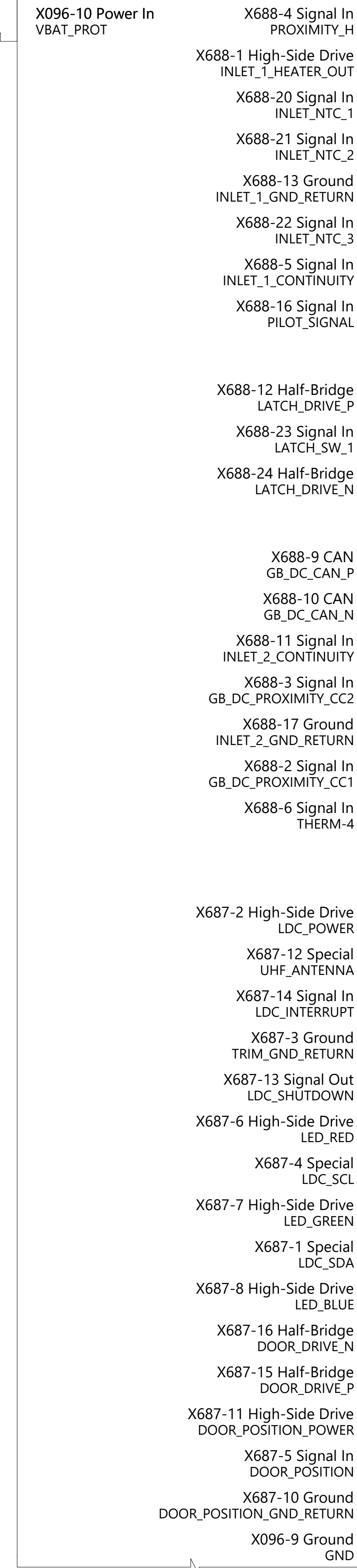

Charge Port Inlet
A

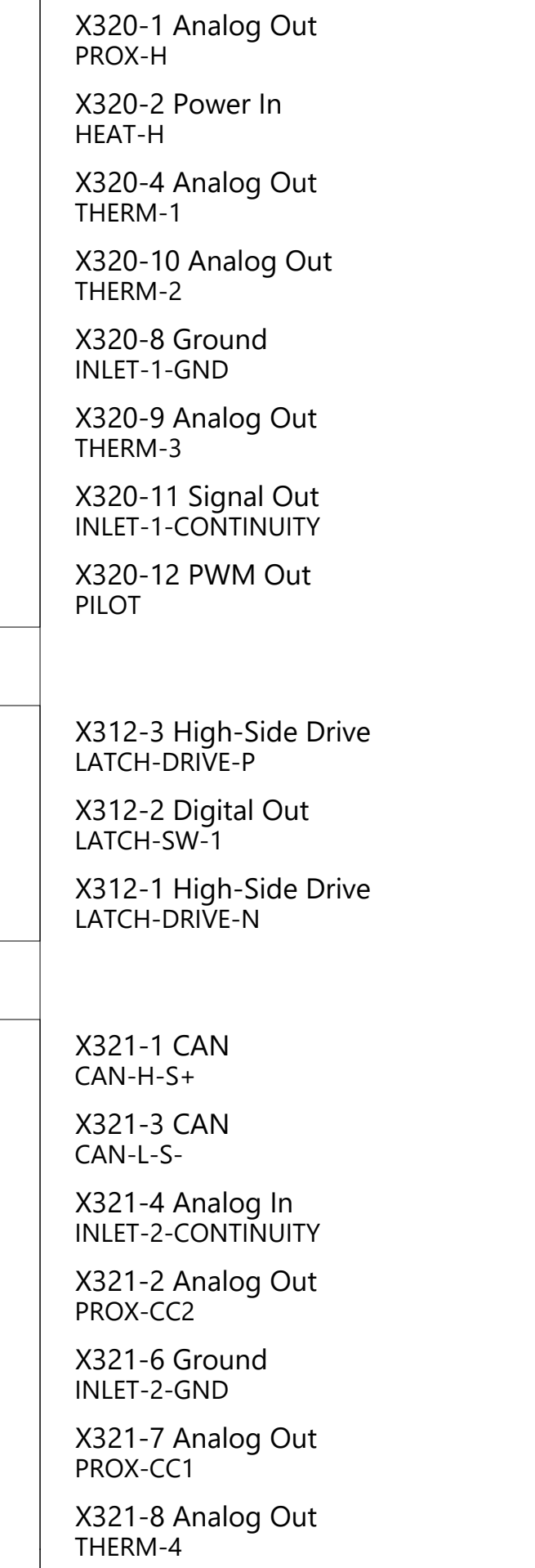

Charge Port Door
Z

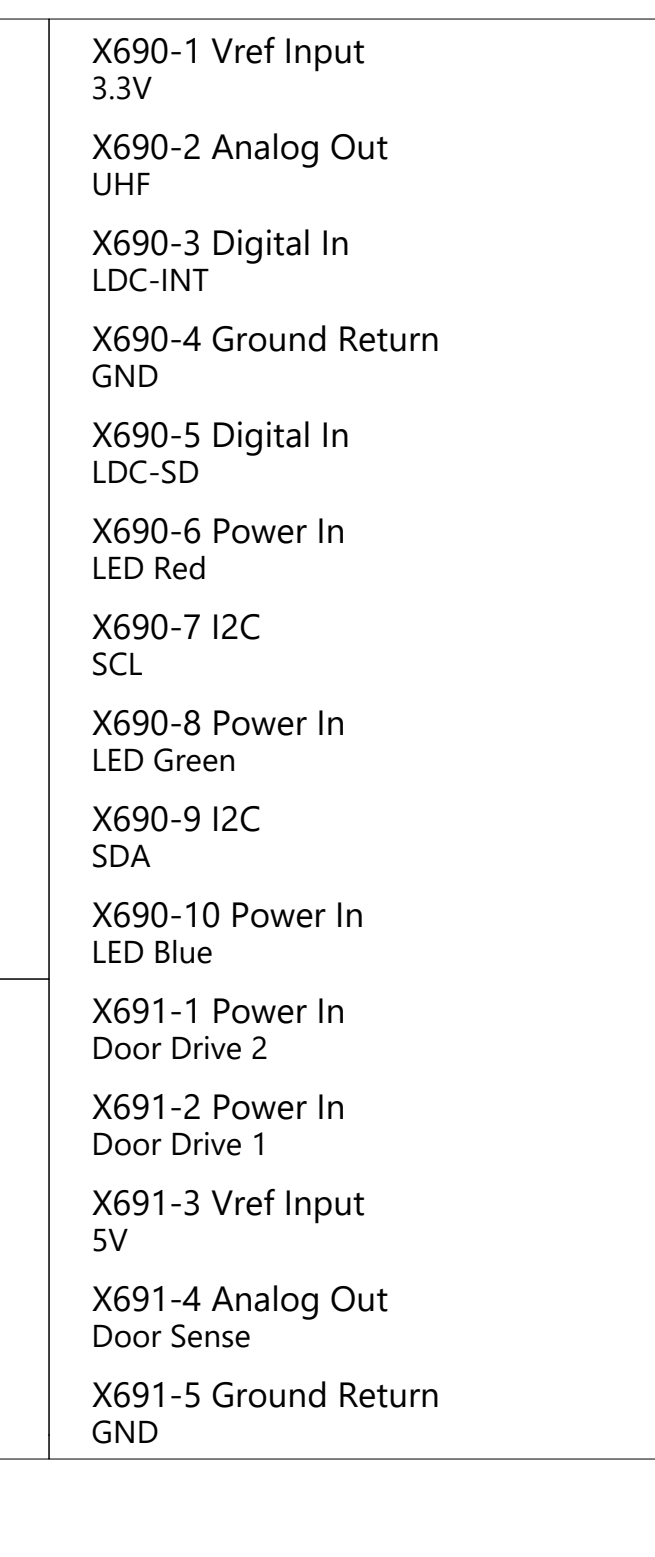

TESLA

THE INFORMATION CONTAINED HEREIN IS DEEMED TO BE CONFIDENTIAL, PROPRIETARY, AND A TRADE SECRET OF TESLA MOTORS. THIS INFORMATION MAY NOT BE USED, REPRODUCED, OR DISCLOSED AS THE DIRECT OR INDIRECT BASIS FOR THE DEVELOPMENT, MANUFACTURE, OR SALE OF PROCESSES OR PRODUCTS WITHOUT THE EXPRESSED WRITTEN CONSENT OF TESLA MOTORS.

DRAWN	CHECKED	APPROVED
-------	---------	----------

MATERIAL AS SPECIFIED	FINISHING AS SPECIFIED	SCALE NONE
--------------------------	---------------------------	---------------

PART NAME
Charge Port Inlet

PART NUMBER	REV	SHEET	SIZE
	1	13 of 54	A0

Body Controller Right
B,P,I,W X056 X050A X050B X051 X059 X057 X053A X053B X052 X055 X058 X060



LHD
MCU (LHD)
W,B



RHD
MCU (RHD)
W,B



CAN Port B

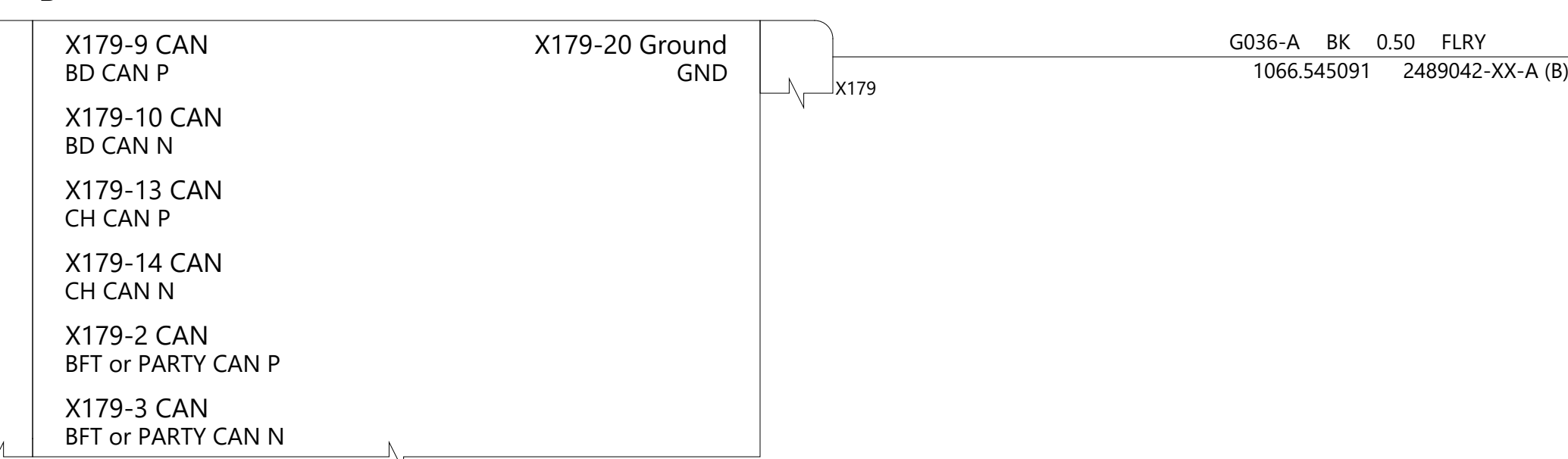

LHD
Diag Connector Cabin (LHD)
W



RHD
Diag Connector Cabin (RHD)
W

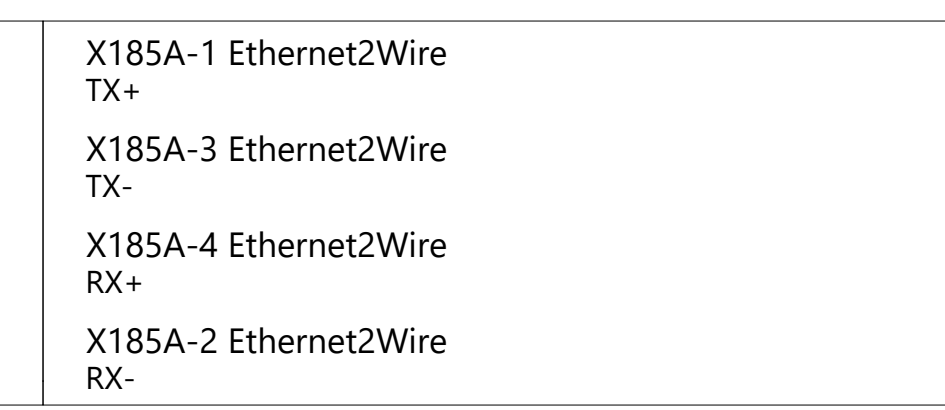

THE INFORMATION CONTAINED HEREIN IS DEEMED TO BE CONFIDENTIAL, PROPRIETARY, AND A TRADE SECRET OF TESLA MOTORS. THIS INFORMATION MAY NOT BE USED, REPRODUCED, OR DISCLOSED AS THE DIRECT OR INDIRECT BASIS FOR THE DEVELOPMENT, MANUFACTURE, OR SALE OF PROCESSES OR PRODUCTS WITHOUT THE EXPRESSED WRITTEN CONSENT OF TESLA MOTORS.

DRAWN	CHECKED	APPROVED
MATERIAL AS SPECIFIED	FINISHING AS SPECIFIED	SCALE NONE
PART NAME Diagnostics		
PART NUMBER	REV	SHEET
	1	14 of 54
		SIZE A0

Body Controller Left
A,D,J,W X036 X030A X030B X031 X039 X037 X033A X033B X032 X035 X038

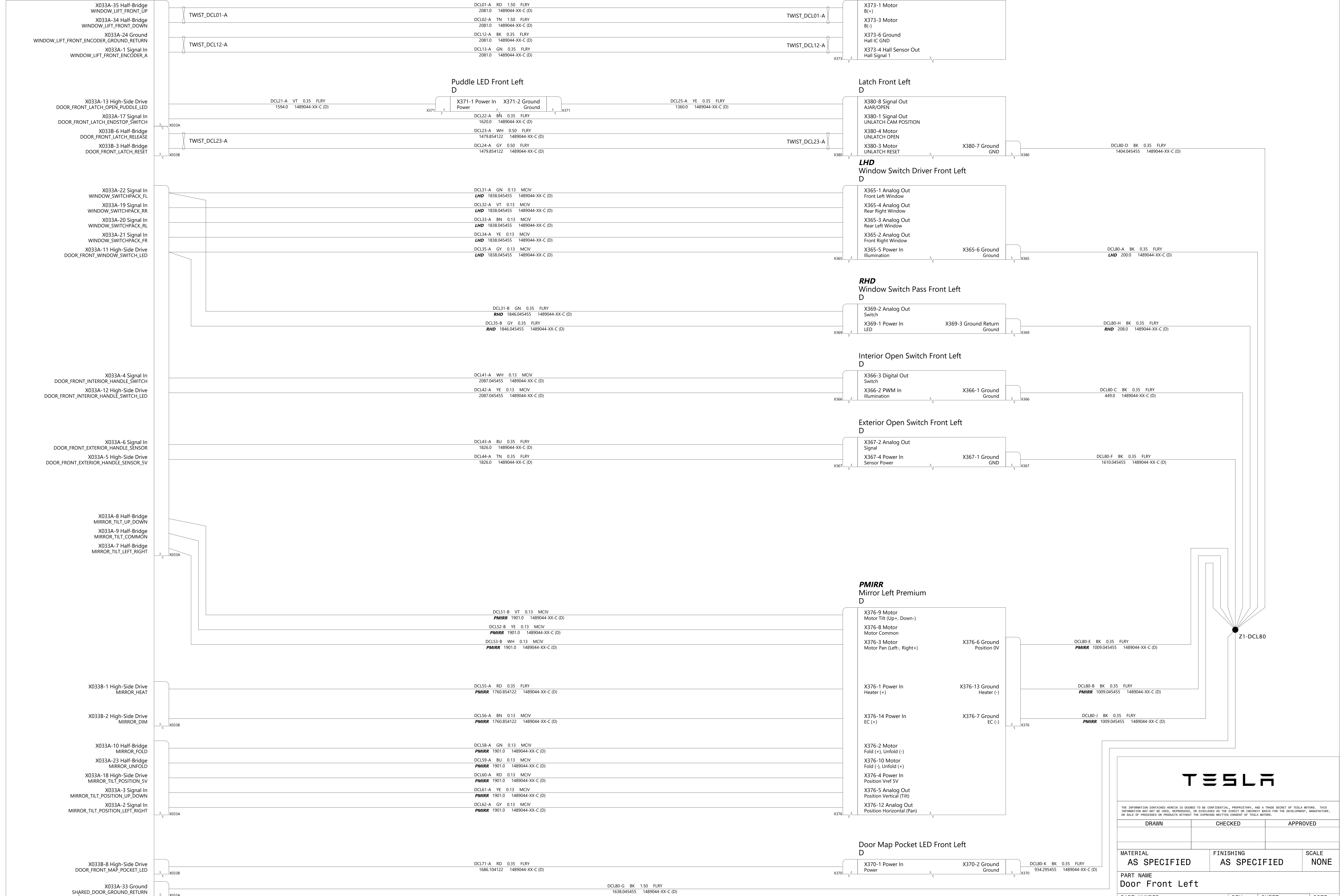

THE INFORMATION CONTAINED HEREIN IS DEEMED TO BE CONFIDENTIAL, PROPRIETARY, AND A TRADE SECRET OF TESLA MOTORS. THIS INFORMATION MAY NOT BE USED, REPRODUCED, OR DISCLOSED AS THE DIRECT OR INDIRECT BASIS FOR THE DEVELOPMENT, MANUFACTURE, OR SALE OF PROCESSES OR PRODUCTS WITHOUT THE EXPRESSED WRITTEN CONSENT OF TESLA MOTORS.

DRAWN	CHECKED	APPROVED
MATERIAL AS SPECIFIED	FINISHING AS SPECIFIED	SCALE NONE
PART NAME Door Front Left		
PART NUMBER	REV	SHEET
	1	15 OF 54
		SIZE A0

Body Controller Right
B,P,J,W X056 X050A X051 X059 X057 X053A X053B X052 X055 X058 X060

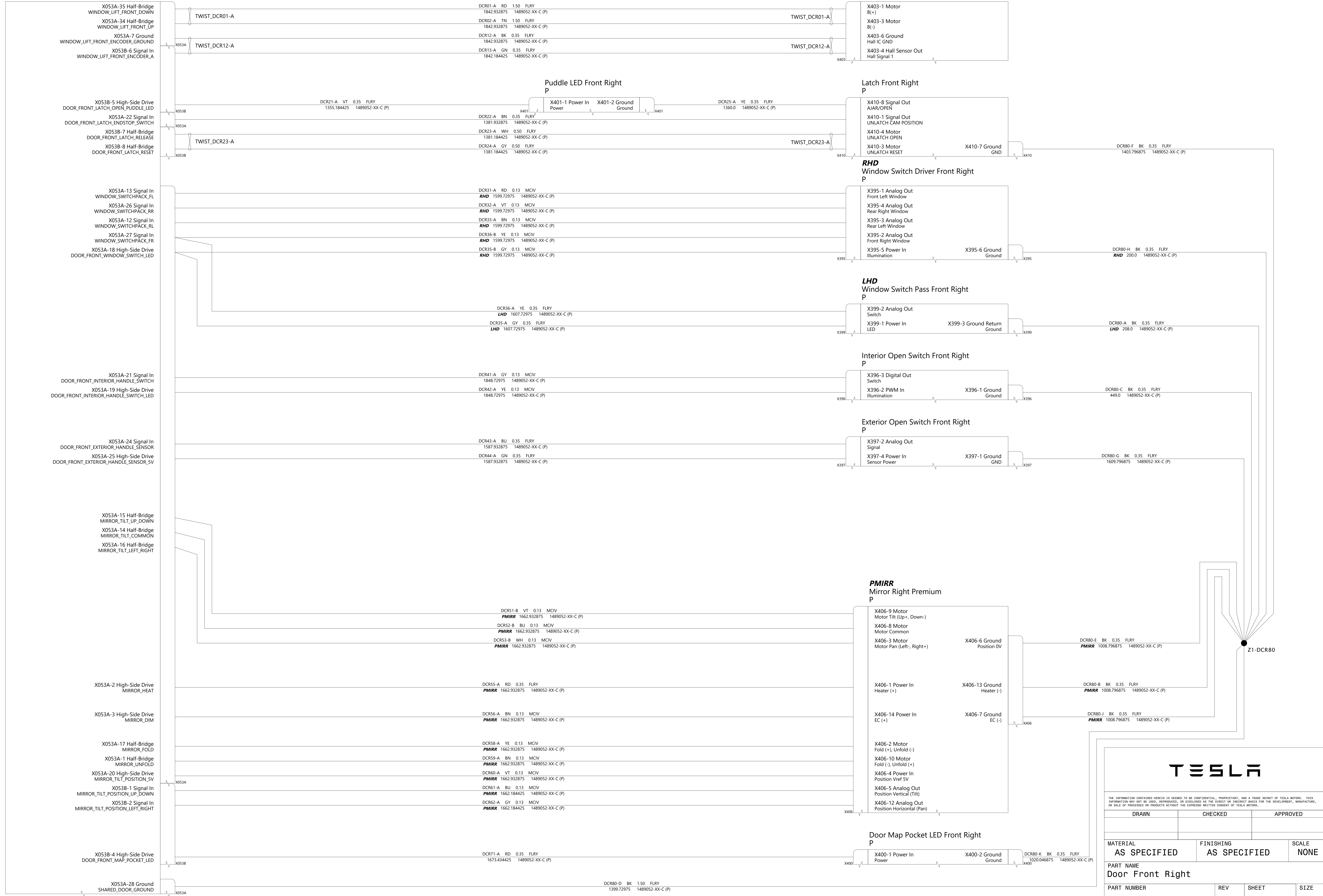

THE INFORMATION CONTAINED HEREIN IS DEEMED TO BE CONFIDENTIAL, PROPRIETARY, AND A TRADE SECRET OF TESLA MOTORS. THIS INFORMATION MAY NOT BE USED, REPRODUCED, OR DISCLOSED AS THE DIRECT OR INDIRECT BASIS FOR THE DEVELOPMENT, MANUFACTURE, OR SALE OF PROCESSES OR PRODUCTS WITHOUT THE EXPRESSED WRITTEN CONSENT OF TESLA MOTORS.

DRAWN	CHECKED	APPROVED
MATERIAL AS SPECIFIED	FINISHING AS SPECIFIED	SCALE NONE
PART NAME Door Front Right		
PART NUMBER	REV 1	SHEET 16 OF 54
		SIZE A0

Body Controller Left
A,D,J,W X036 X030A X030B X031 X039 X037 X033A X033B X032 X035 X038

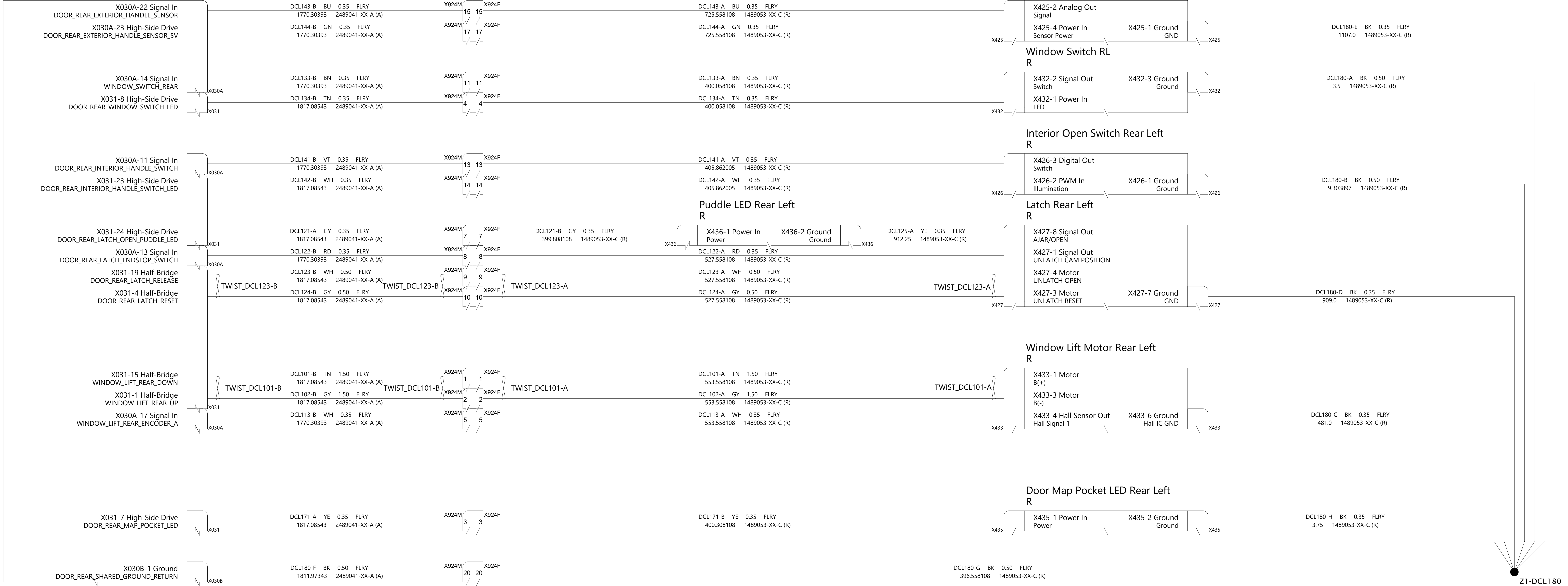

Body Controller Right
B,P,J,W X056 X050A X050B X051 X059 X057 X053A X053B X052 X055 X058 X060

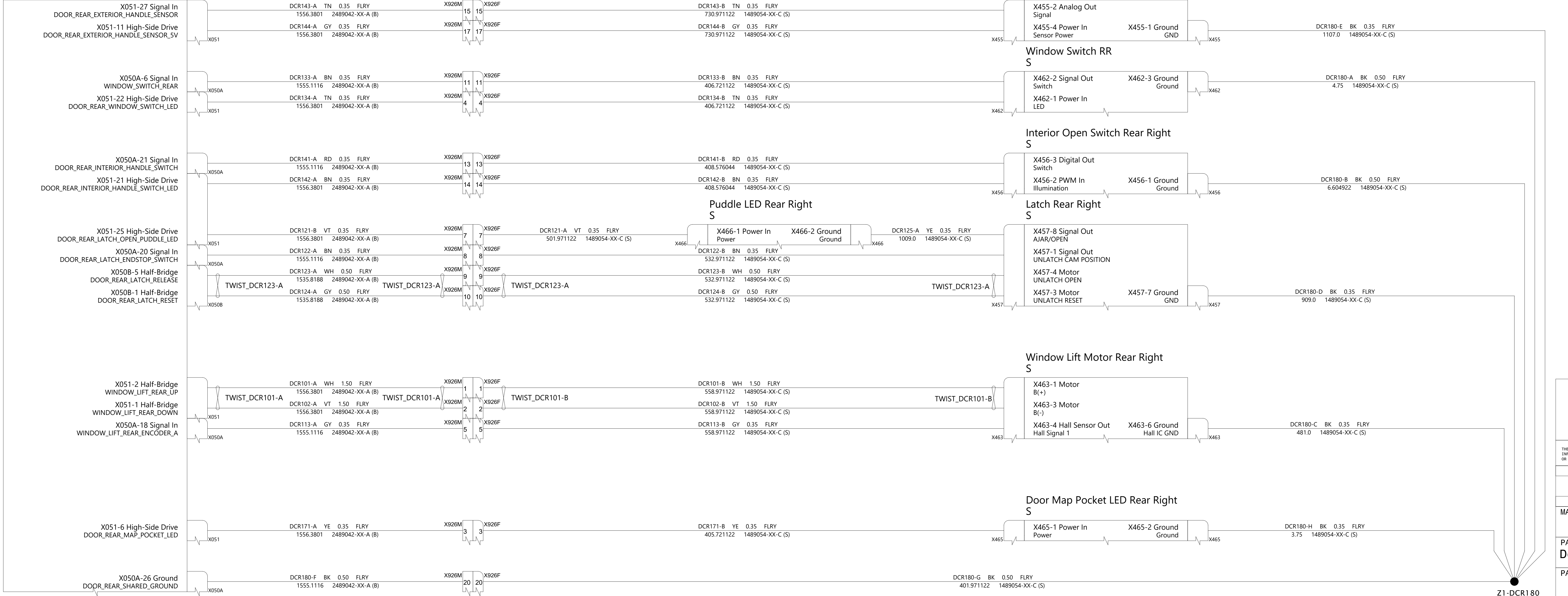

TESLA			
THE INFORMATION CONTAINED HEREIN IS DEEMED TO BE CONFIDENTIAL, PROPRIETARY, AND A TRADE SECRET OF TESLA MOTORS. THIS INFORMATION MAY NOT BE USED, REPRODUCED, OR DISCLOSED AS THE DIRECT OR INDIRECT BASIS FOR THE DEVELOPMENT, MANUFACTURE, OR SALE OF PROCESSES OR PRODUCTS WITHOUT THE EXPRESSED WRITTEN CONSENT OF TESLA MOTORS.			
DRAWN	CHECKED	APPROVED	
MATERIAL AS SPECIFIED	FINISHING AS SPECIFIED	SCALE NONE	
PART NAME Doors Rear			
PART NUMBER	REV 1	SHEET 17 of 54	SIZE A0

Body Controller Front
W,U X021 X012 X011 X010 X015 X014

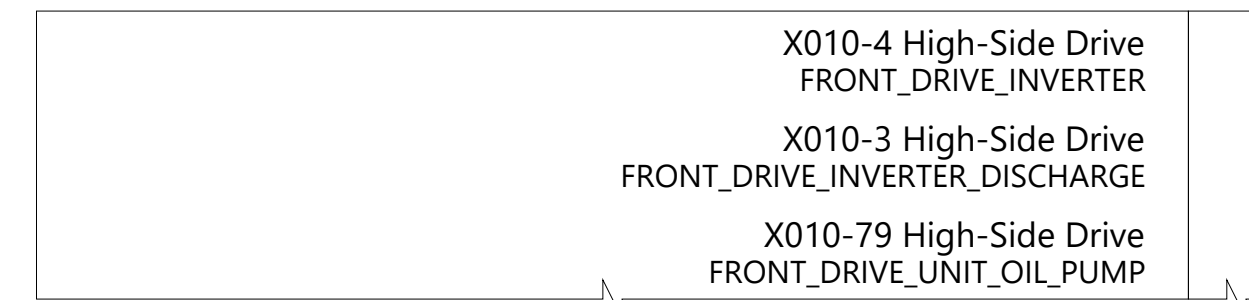

AWD Drive Inverter Front & Resolver
N X093 X094

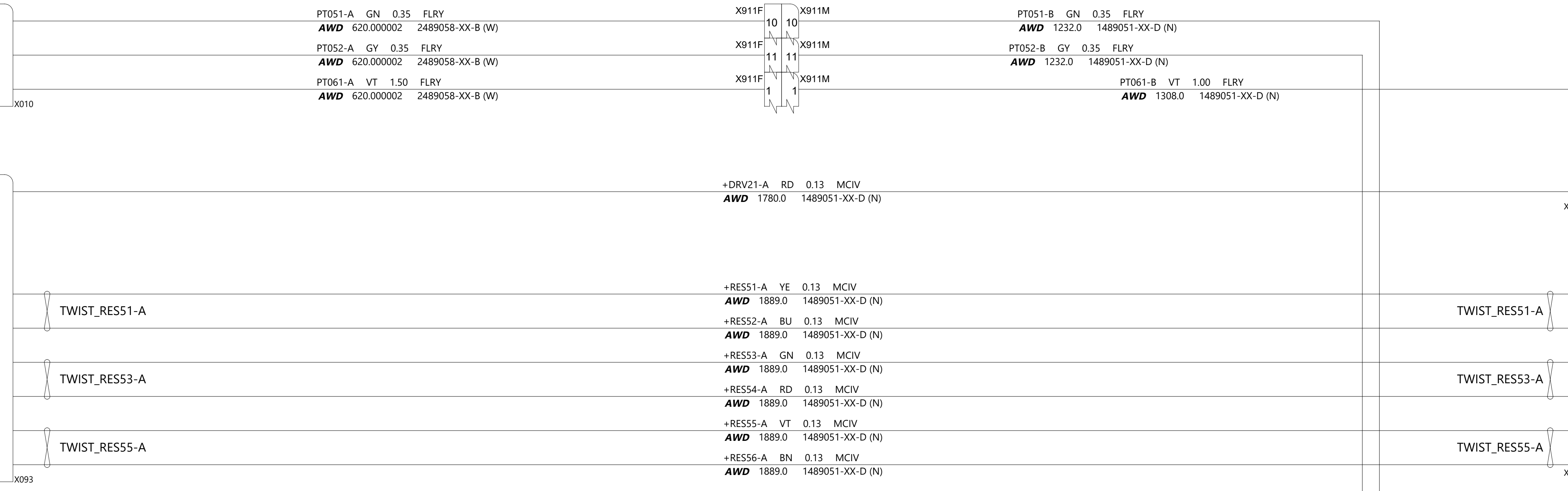
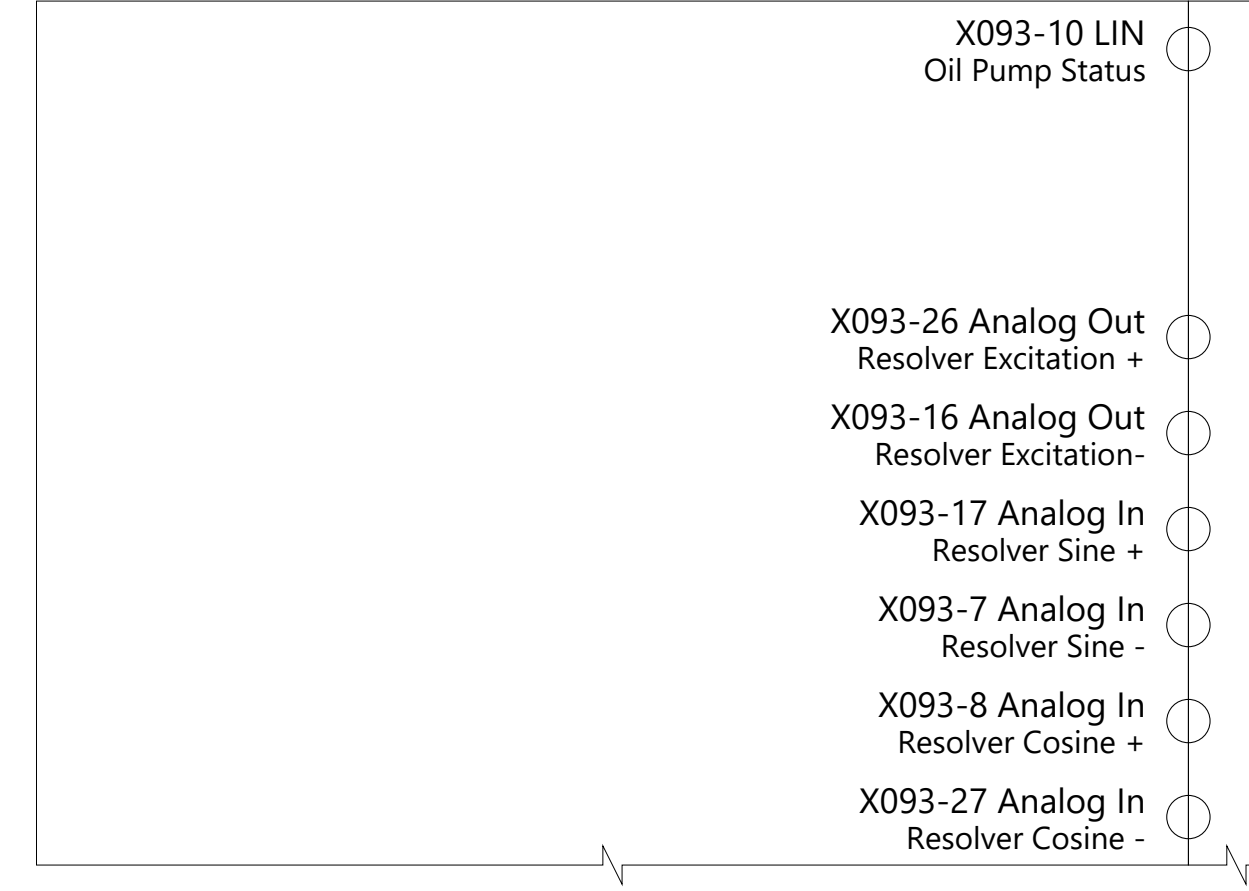

AWD Drive Unit Oil Pump Front
N

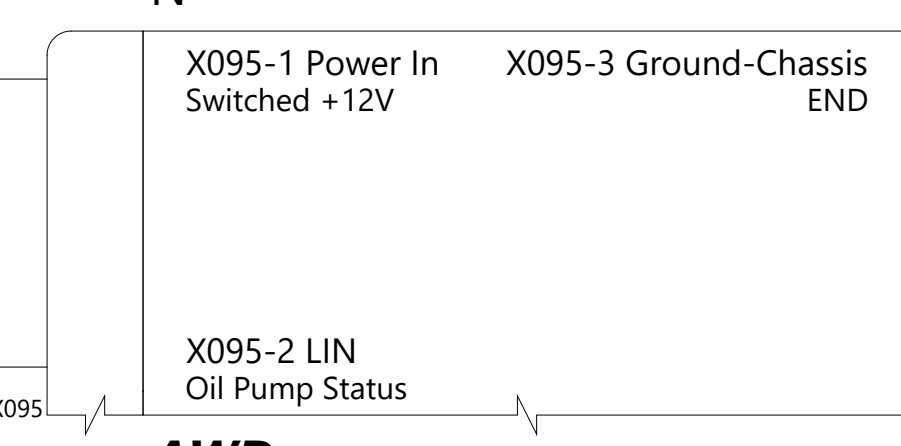

AWD Drive Inverter Front & Resolver
N X093 X094

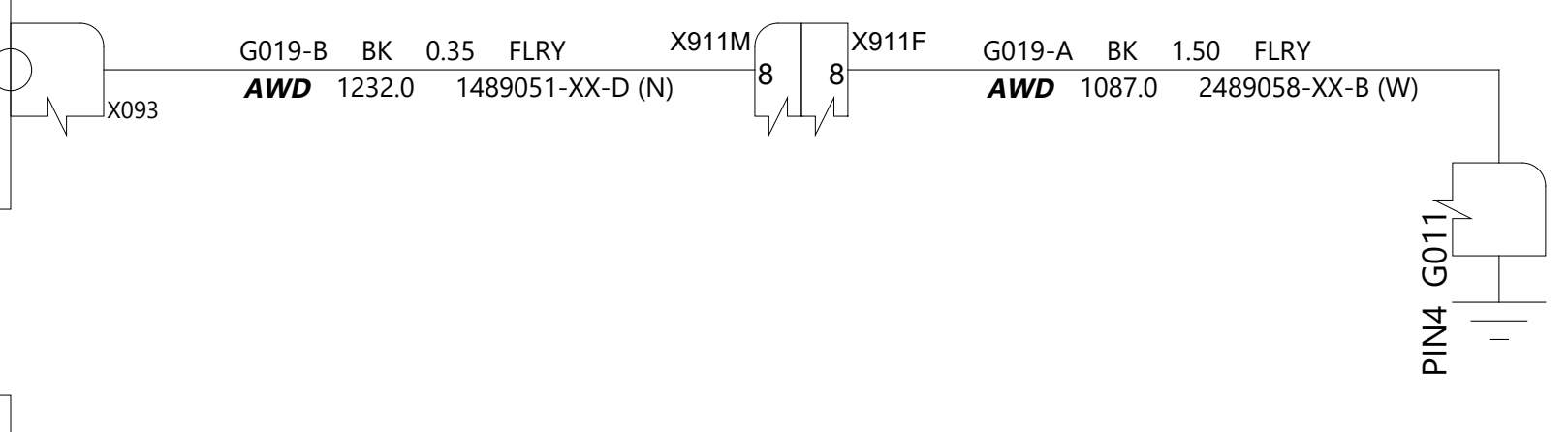
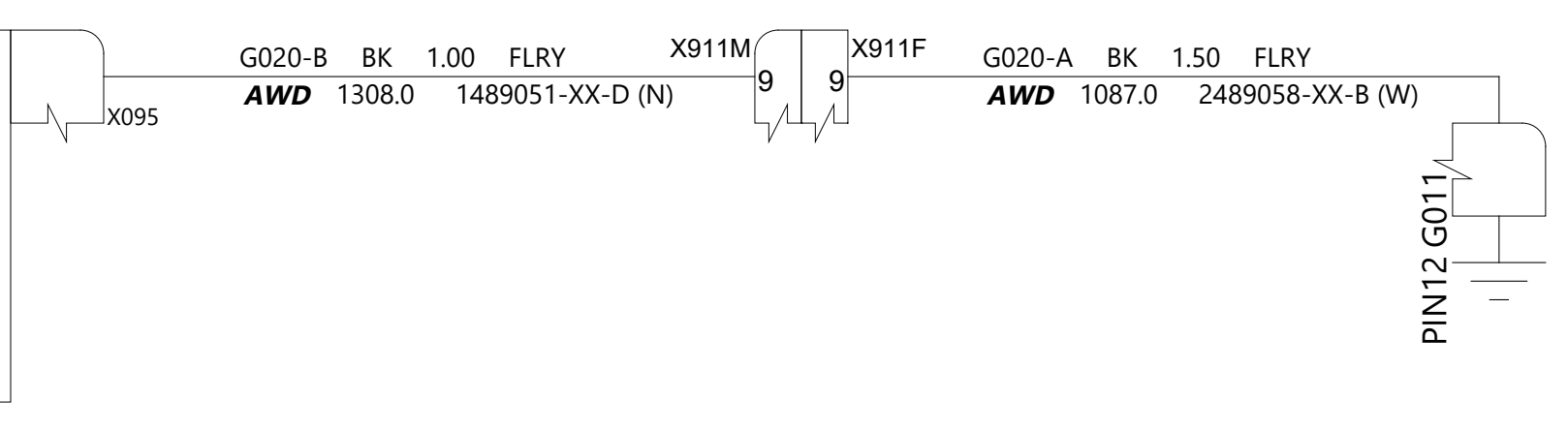
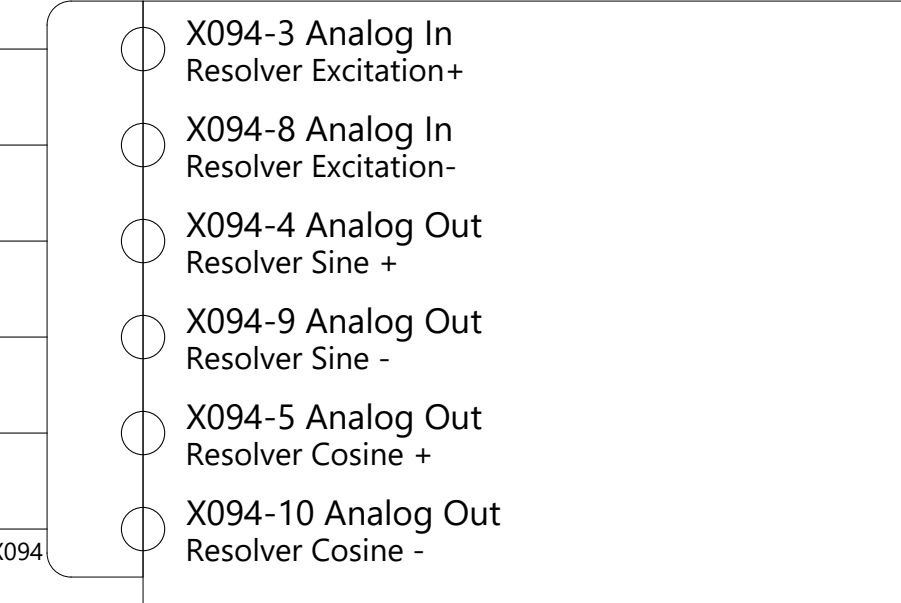

Drive Inverter Rear & Resolver
X X090 X091

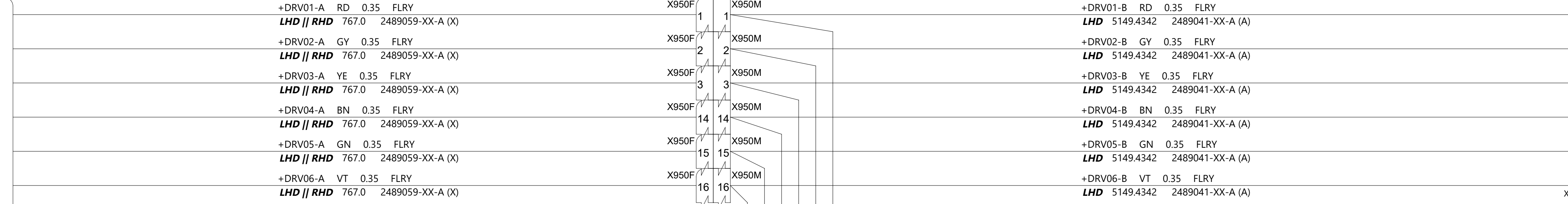

Accel Pedal Sensor (LHD)
A LHD

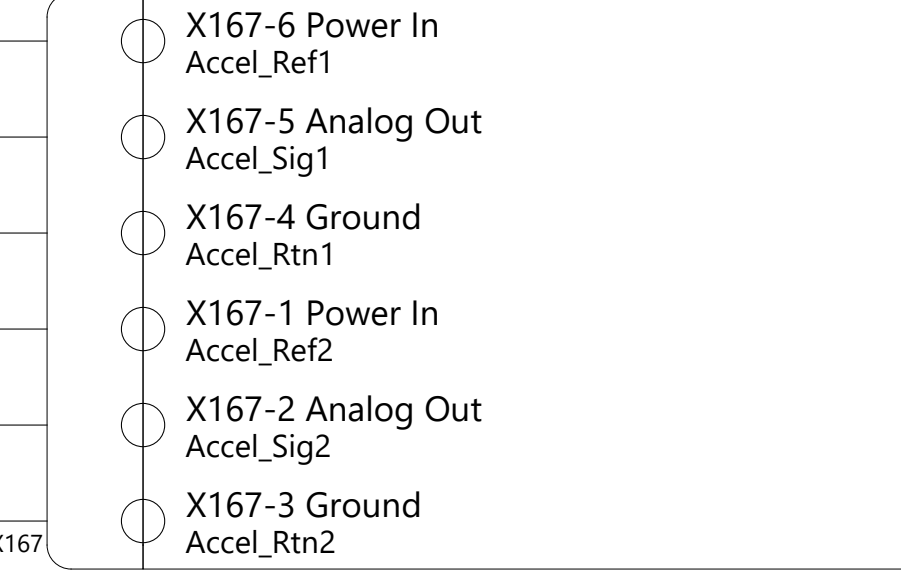

RHD Accel Pedal Sensor (RHD)
B

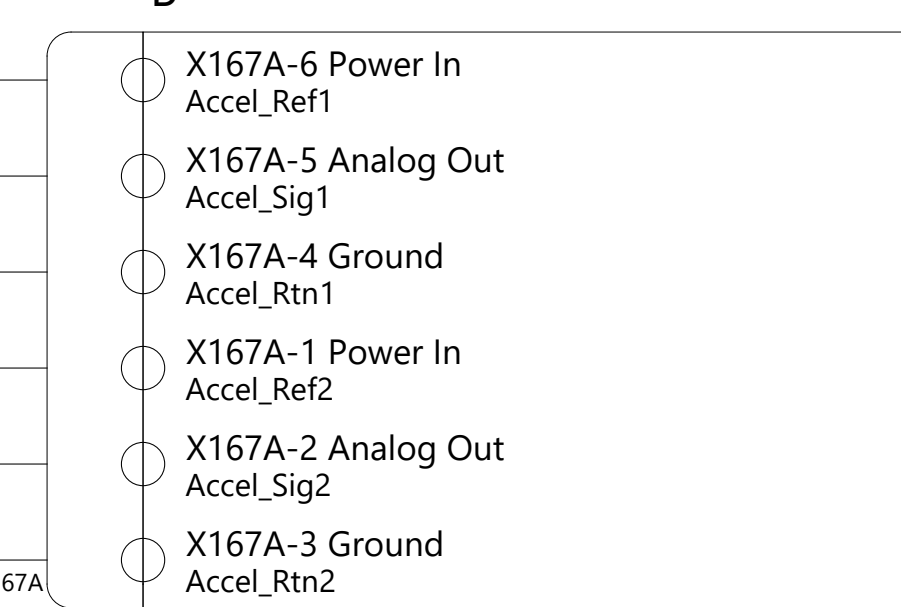

Drive Inverter Rear & Resolver
X X090 X091

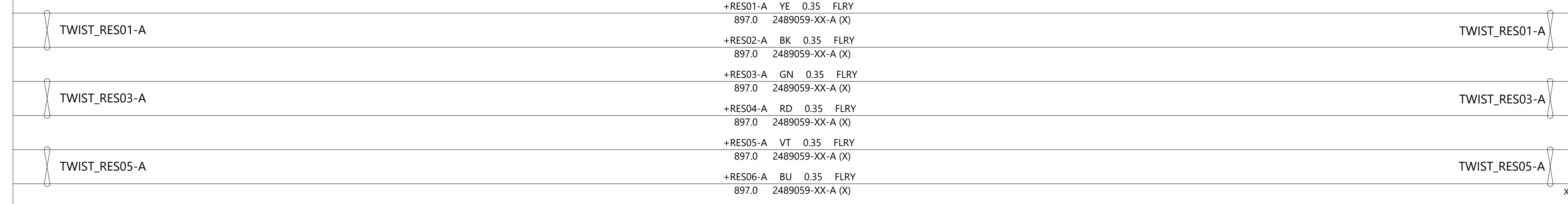
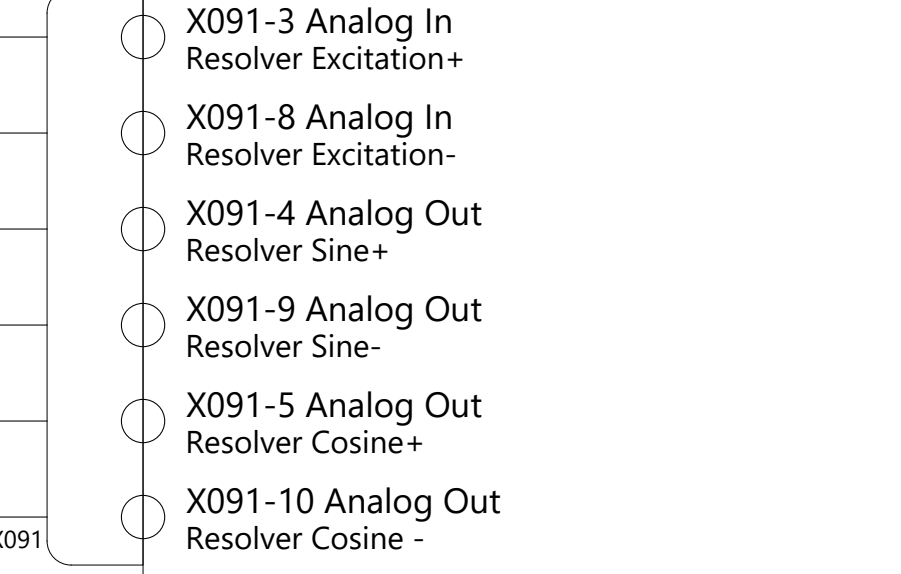

Body Controller Left
A,D,J,W X036 X030A X030B X031 X039 X037 X033A X033B X032 X035 X038

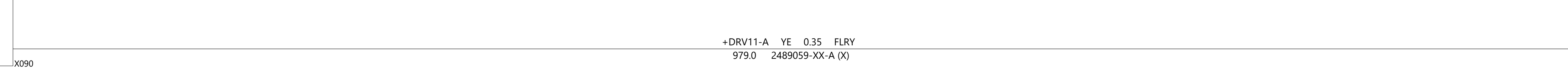
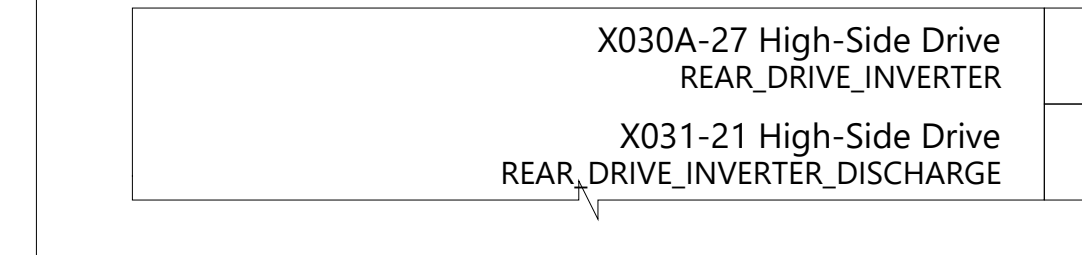

Body Controller Right
B,P,J,W X056 X050A X050B X051 X059 X057 X053A X053B X052 X055 X058 X060



Drive Unit Oil Pump Rear
X

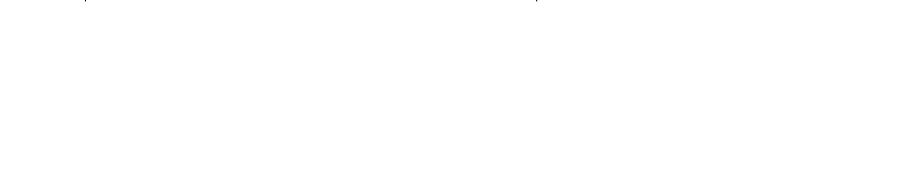
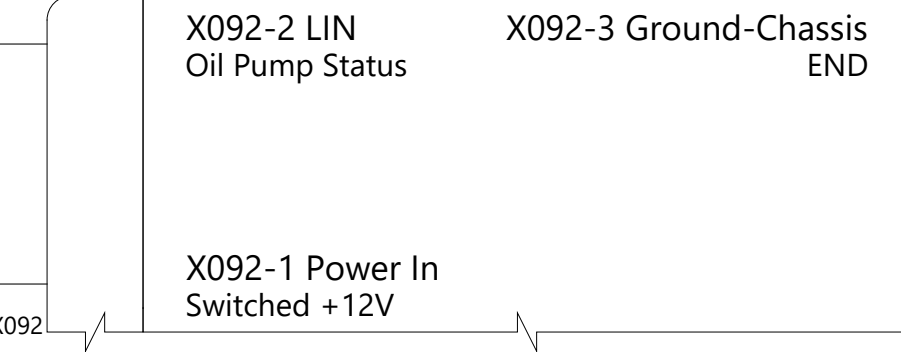

THE INFORMATION CONTAINED HEREIN IS DEEMED TO BE CONFIDENTIAL, PROPRIETARY, AND A TRADE SECRET OF TESLA MOTORS. THIS INFORMATION MAY NOT BE USED, REPRODUCED, OR DISCLOSED AS THE DIRECT OR INDIRECT BASIS FOR THE DEVELOPMENT, MANUFACTURE, OR SALE OF PROCESSES OR PRODUCTS WITHOUT THE EXPRESSED WRITTEN CONSENT OF TESLA MOTORS.

DRAWN	CHECKED	APPROVED
-------	---------	----------

MATERIAL AS SPECIFIED	FINISHING AS SPECIFIED	SCALE NONE
--------------------------	---------------------------	---------------

PART NAME
Drive Inverters

PART NUMBER	REV	SHEET	SCALE
	1	18 of 54	A0

Body Controller Front
W,U X021 X012 X011 X010 X015 X014

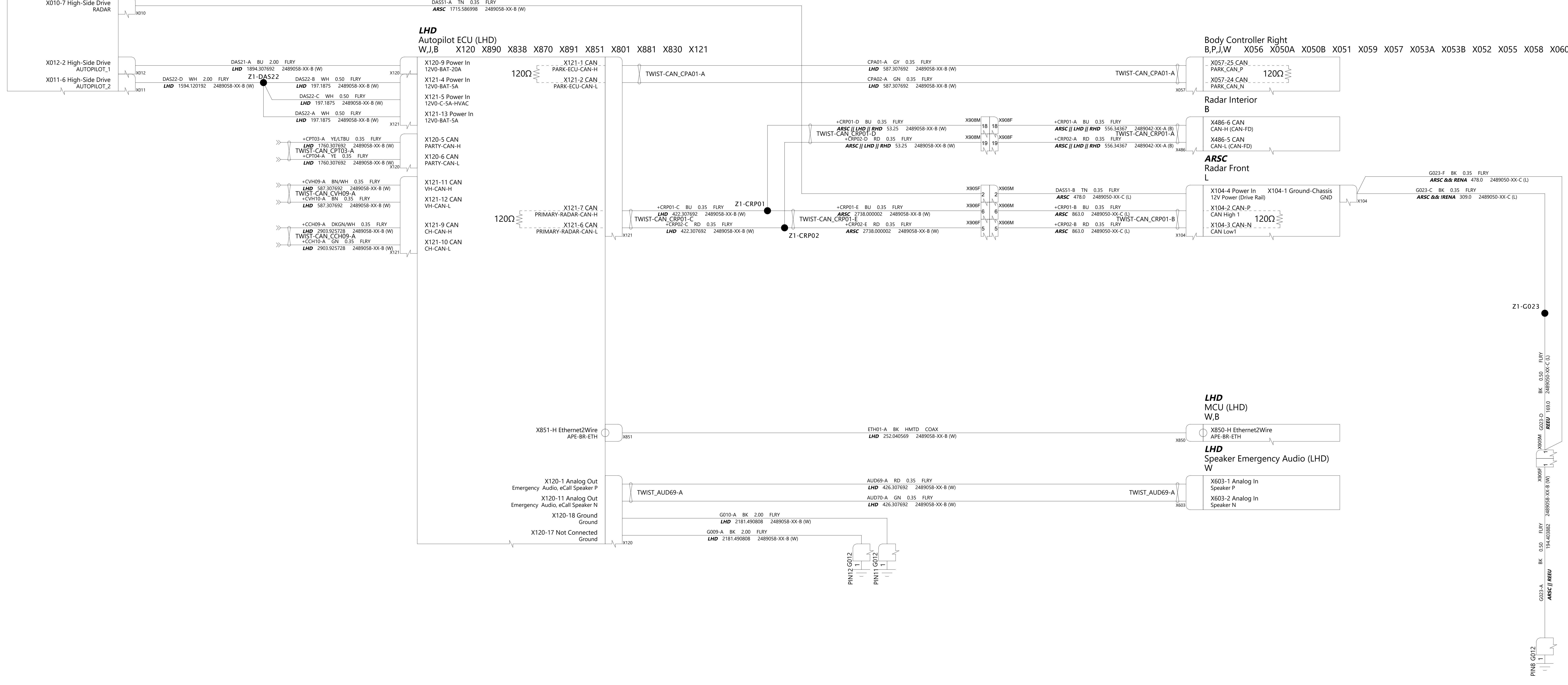

THE INFORMATION CONTAINED HEREIN IS DEEMED TO BE CONFIDENTIAL, PROPRIETARY, AND A TRADE SECRET OF TESLA MOTORS. THIS INFORMATION MAY NOT BE USED, REPRODUCED, OR DISCLOSED AS THE DIRECT OR INDIRECT BASIS FOR THE DEVELOPMENT, MANUFACTURE, OR SALE OF PROCESSES OR PRODUCTS WITHOUT THE EXPRESS WRITTEN CONSENT OF TESLA MOTORS.

DRAWN	CHECKED	APPROVED
-------	---------	----------

MATERIAL AS SPECIFIED	FINISHING AS SPECIFIED	SCALE NONE
--------------------------	---------------------------	---------------

PART NAME
Driver Assistance

PART NUMBER	REV	SHEET	SIZE
	1	19 OF 54	A0

Body Controller Front
W,U X021 X012 X011 X010 X015 X014

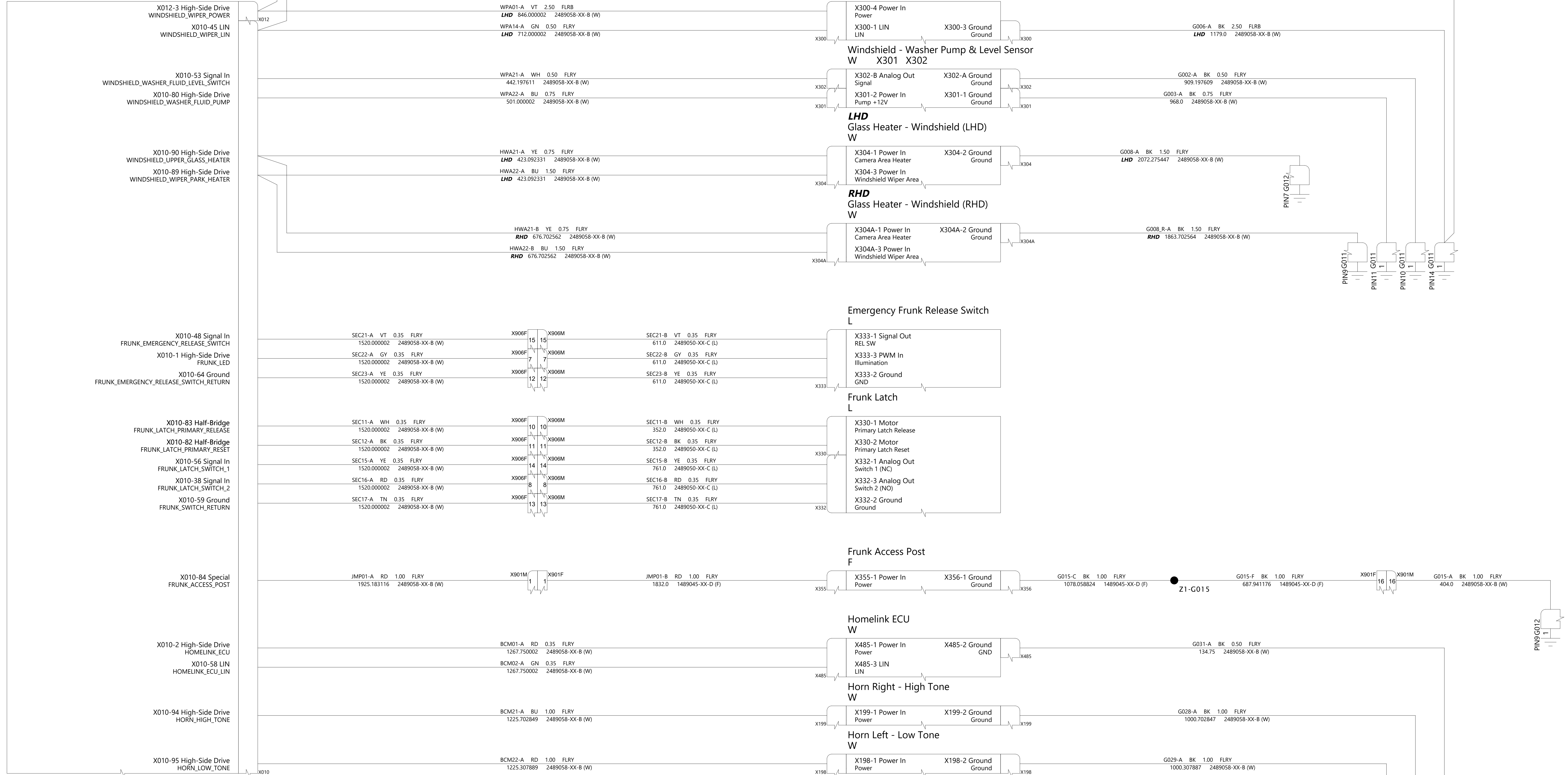

THE INFORMATION CONTAINED HEREIN IS DEEMED TO BE CONFIDENTIAL, PROPRIETARY, AND A TRADE SECRET OF TESLA MOTORS. THIS INFORMATION MAY NOT BE USED, REPRODUCED, OR DISCLOSED AS THE DIRECT OR INDIRECT BASIS FOR THE DEVELOPMENT, MANUFACTURE, OR SALE OF PROCESSES OR PRODUCTS WITHOUT THE EXPRESSED WRITTEN CONSENT OF TESLA MOTORS.

DRAWN	CHECKED	APPROVED
MATERIAL AS SPECIFIED	FINISHING AS SPECIFIED	SCALE NONE
PART NAME Frunk Actuator/Sensors		
PART NUMBER	REV	SHEET
	1	21 of 54
		SCALE A0

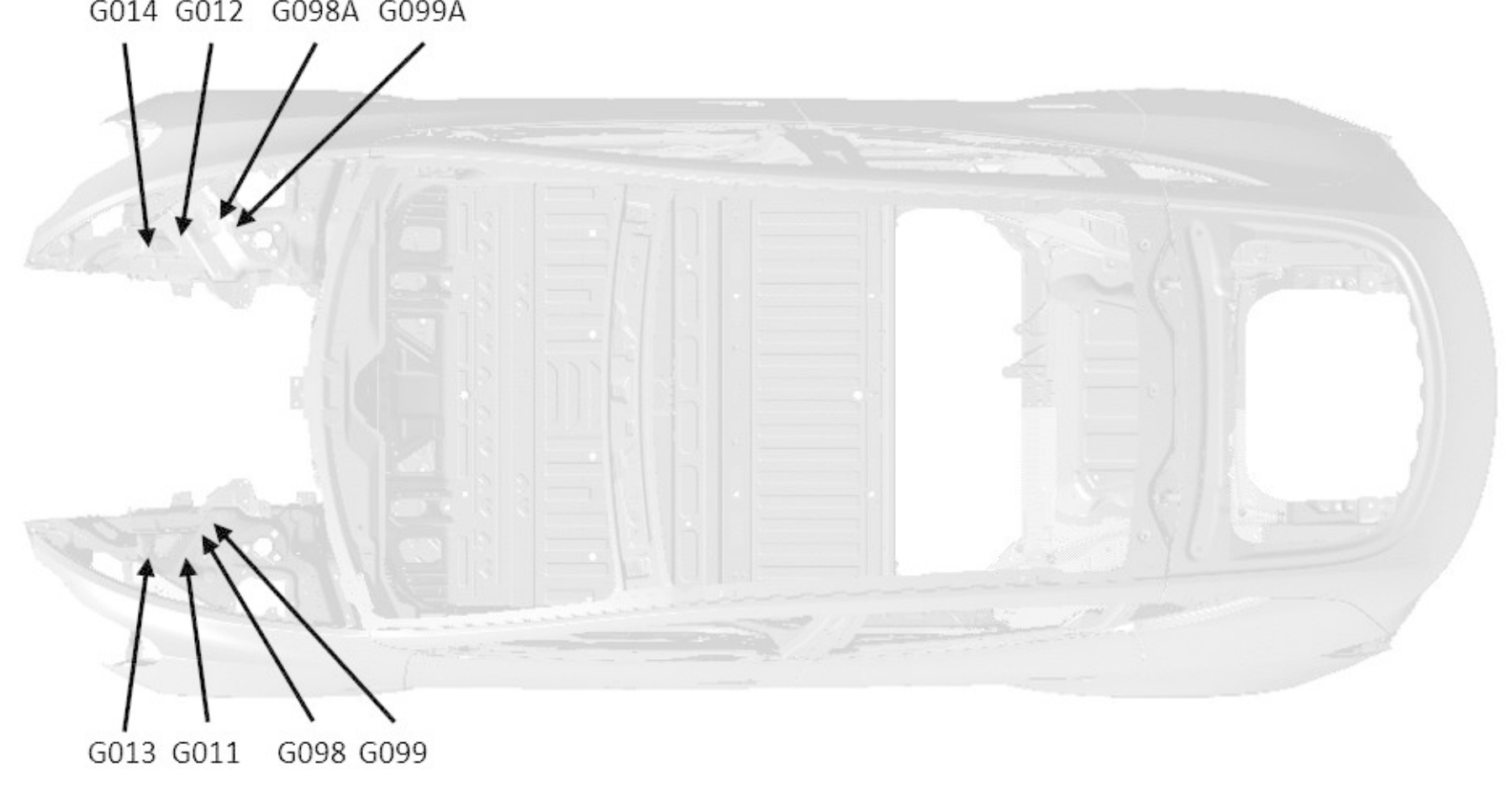
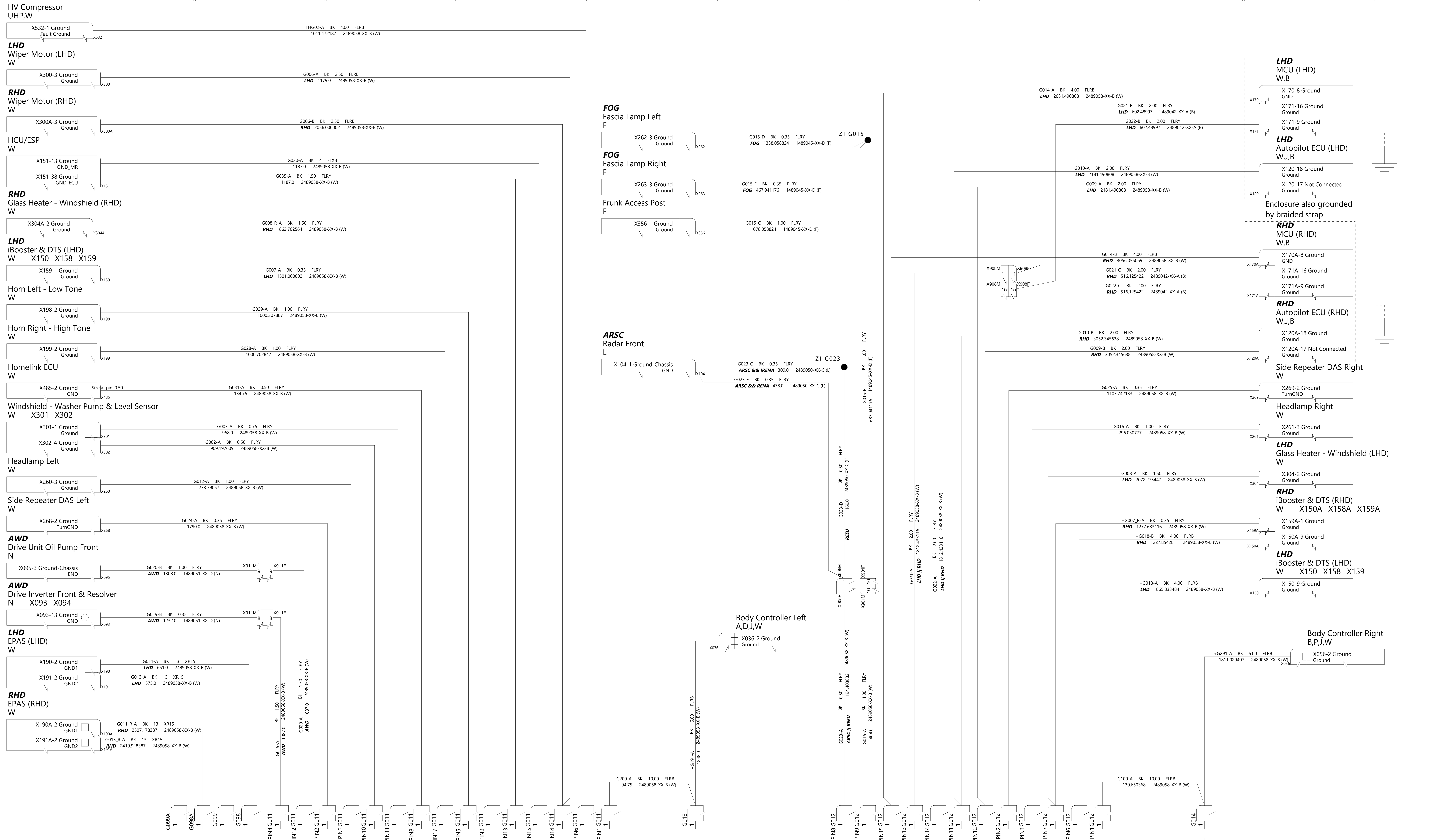

TESLA			
THE INFORMATION CONTAINED HEREIN IS DEEMED TO BE CONFIDENTIAL, PROPRIETARY, AND A TRADE SECRET OF TESLA MOTORS. THIS INFORMATION MAY NOT BE USED, REPRODUCED, OR DISCLOSED AS THE DIRECT OR INDIRECT BASIS FOR THE DEVELOPMENT, MANUFACTURE, OR SALE OF PROCESSES OR PRODUCTS WITHOUT THE EXPRESSED WRITTEN CONSENT OF TESLA MOTORS.			
DRAWN	CHECKED	APPROVED	
MATERIAL AS SPECIFIED		FINISHING AS SPECIFIED	SCALE NONE
PART NAME Grounding - Frunk			
PART NUMBER	REV	SHEET	SIZE
	1	23 of 54	A0

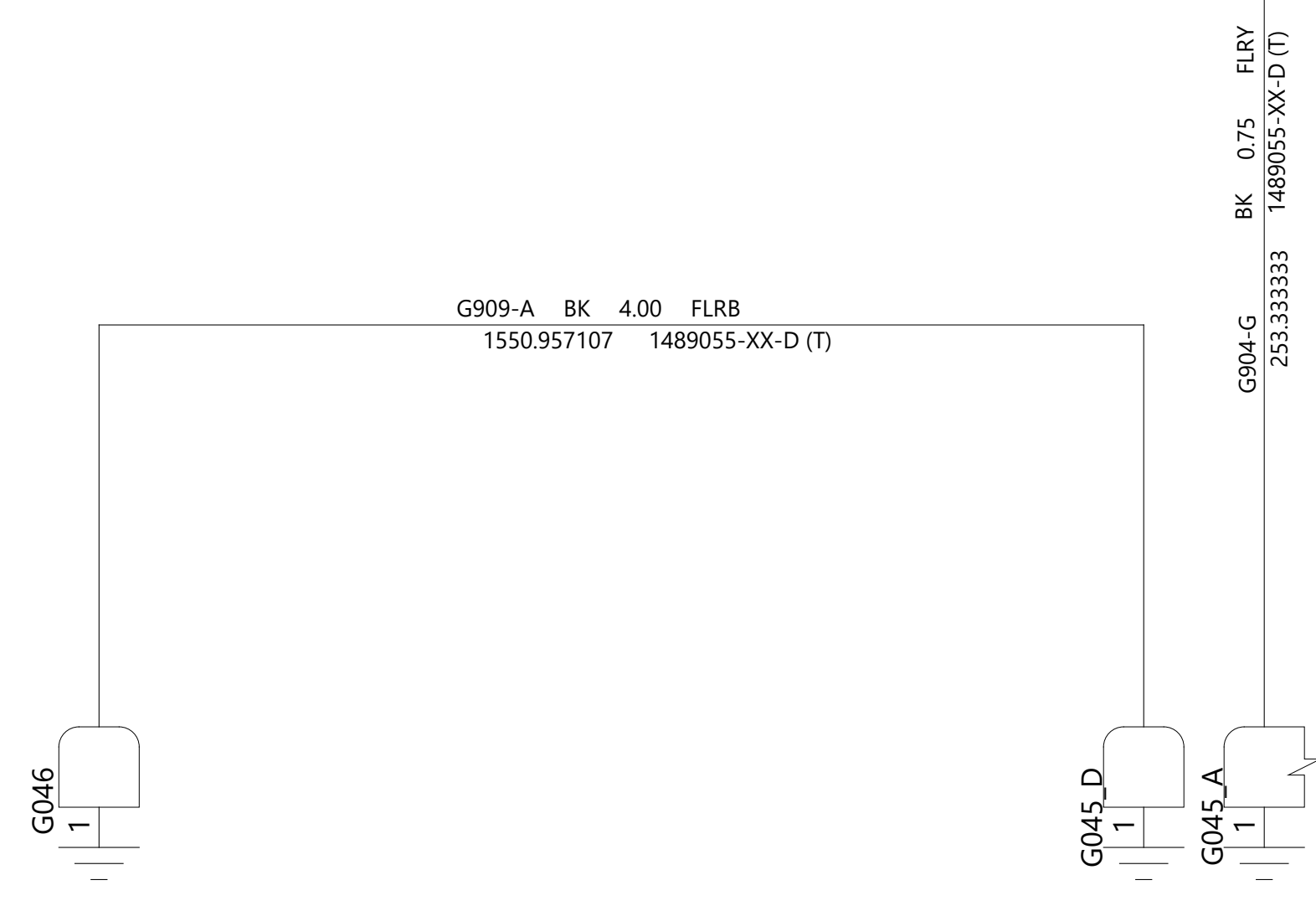
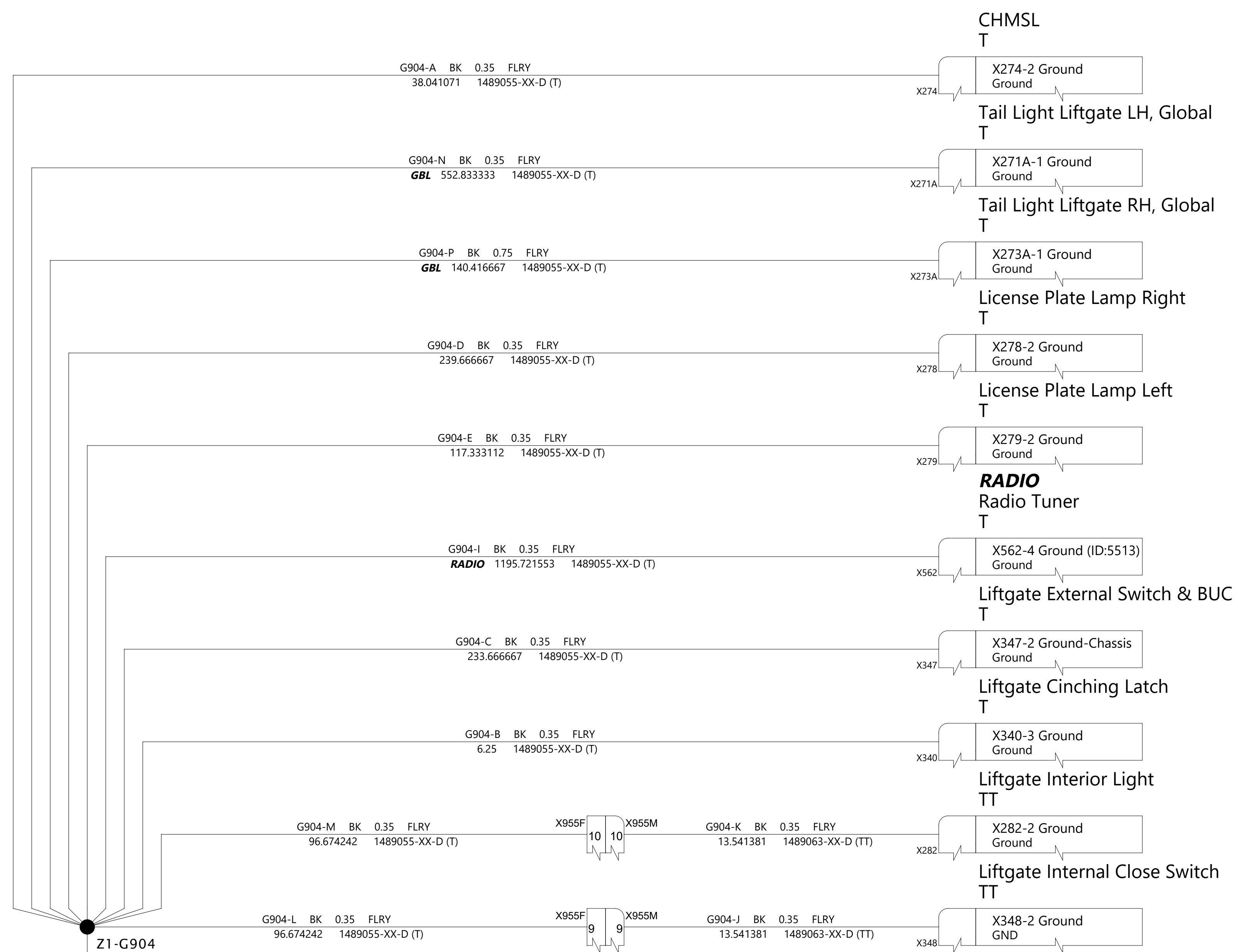

TESLA

THE INFORMATION CONTAINED HEREIN IS DEEMED TO BE CONFIDENTIAL, PROPRIETARY, AND A TRADE SECRET OF TESLA MOTORS. THIS INFORMATION MAY NOT BE USED, REPRODUCED, OR DISCLOSED AS THE DIRECT OR INDIRECT BASIS FOR THE DEVELOPMENT, MANUFACTURE, OR SALE OF PROCESSES OR PRODUCTS WITHOUT THE EXPRESSED WRITTEN CONSENT OF TESLA MOTORS.

DRAWN	CHECKED	APPROVED	
MATERIAL AS SPECIFIED	FINISHING AS SPECIFIED	SCALE NONE	
PART NAME Grounding - Liftgate			
PART NUMBER	REV	SHEET	SIZE
	1	24 OF 54	A0

Body Controller Left
A,D,J,W

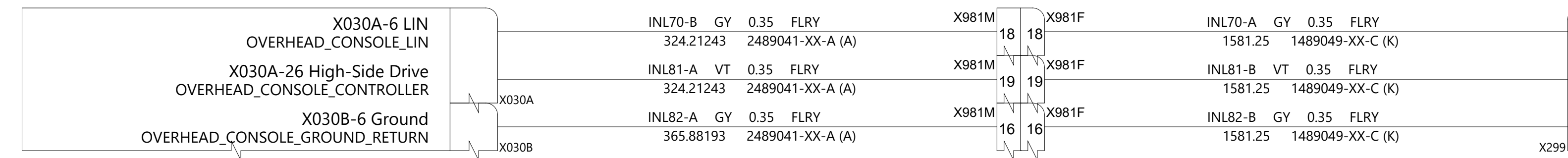

Overhead Console Front
K

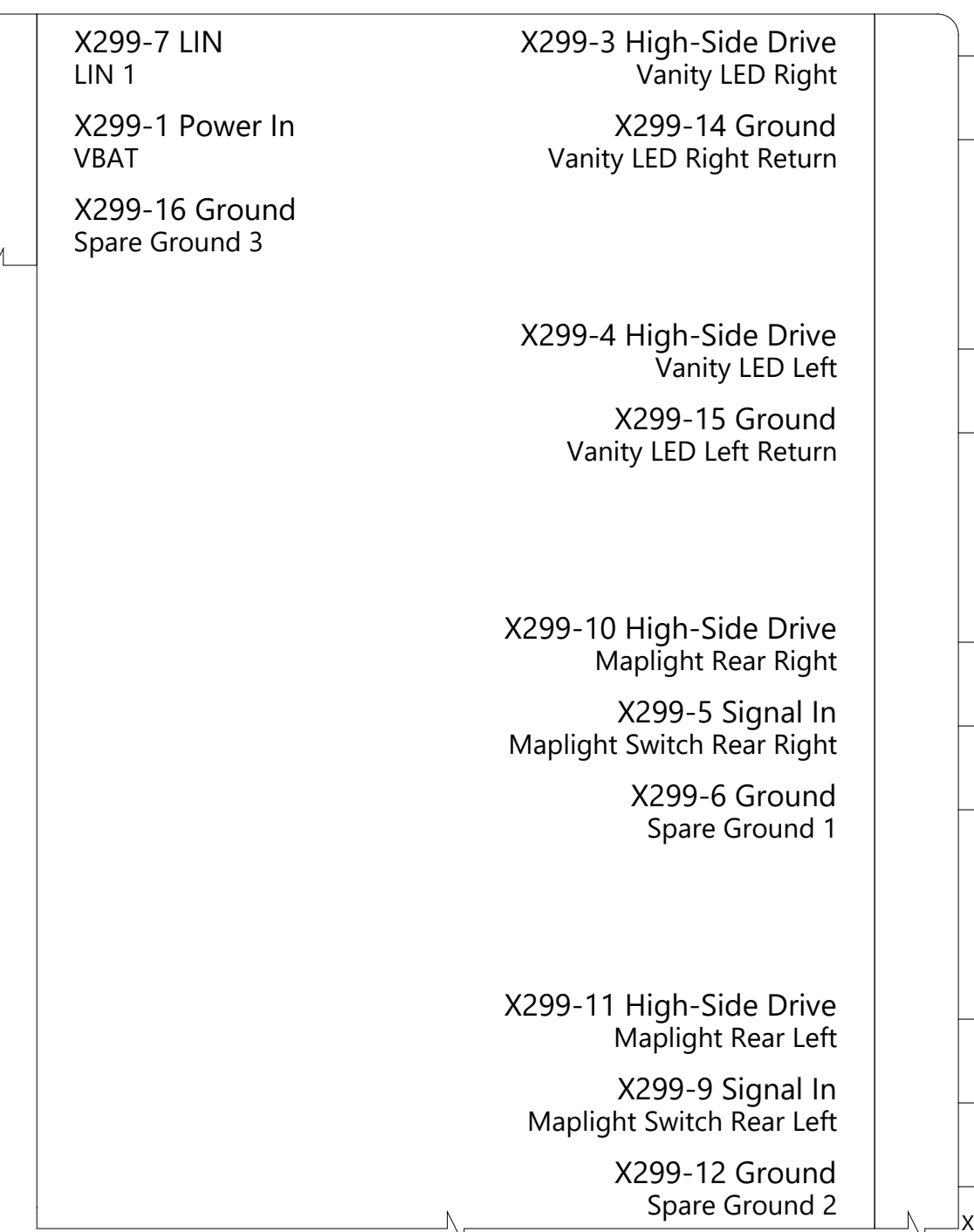

Vanity LED Right
K

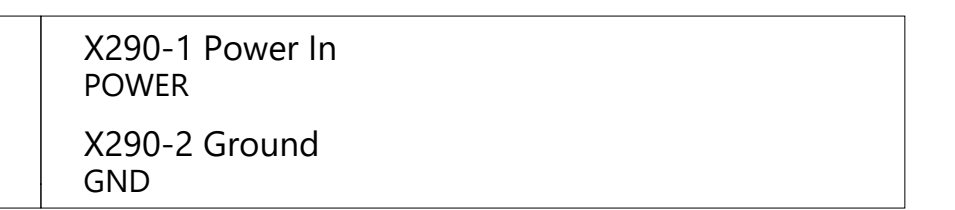

Vanity LED Left
K



Rear Maplight RH
K

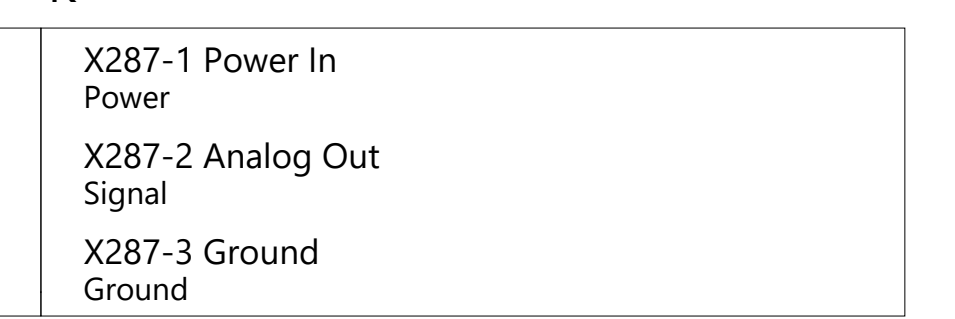

Rear Maplight LH
K

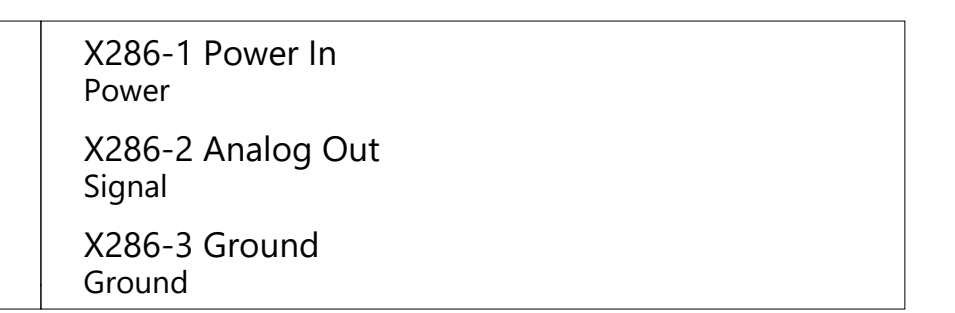

Body Controller Right
B,P,J,W

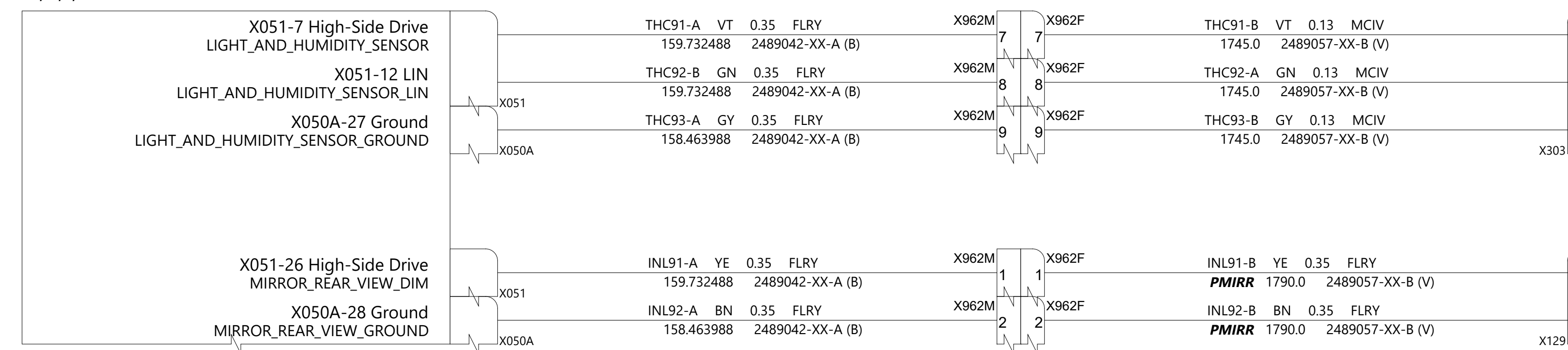

Humidity and Glass Temp
V

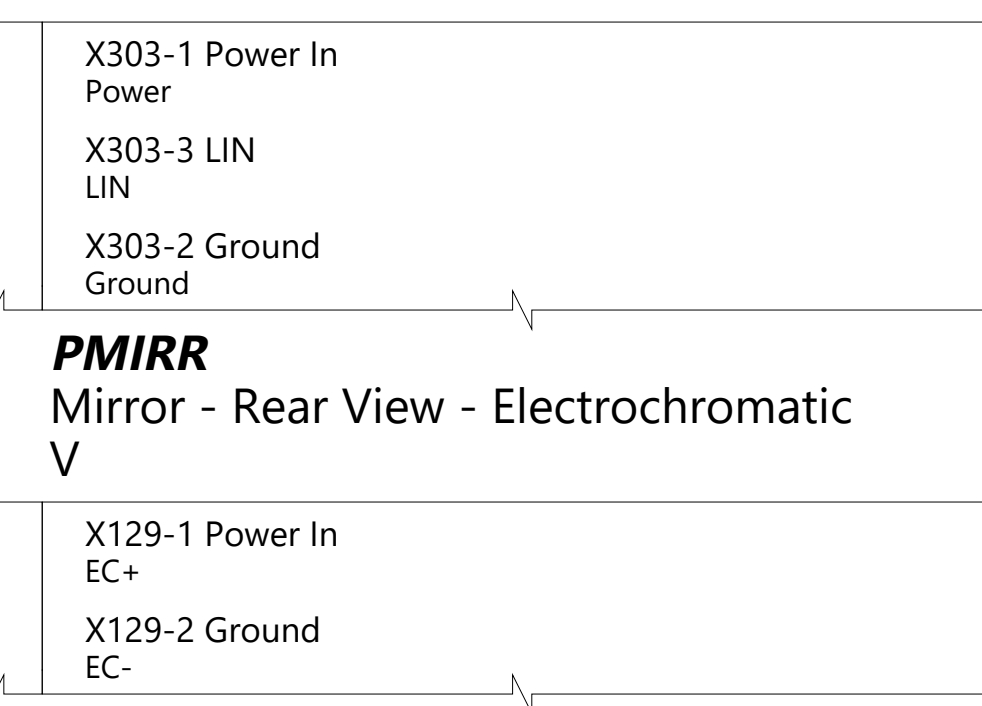

THE INFORMATION CONTAINED HEREIN IS DEEMED TO BE CONFIDENTIAL, PROPRIETARY, AND A TRADE SECRET OF TESLA MOTORS. THIS INFORMATION MAY NOT BE USED, REPRODUCED, OR DISCLOSED AS THE DIRECT OR INDIRECT BASIS FOR THE DEVELOPMENT, MANUFACTURE, OR SALE OF PROCESSES OR PRODUCTS WITHOUT THE EXPRESSED WRITTEN CONSENT OF TESLA MOTORS.

DRAWN	CHECKED	APPROVED
MATERIAL AS SPECIFIED		SCALE NONE
PART NAME Headliner		SCALE NONE
PART NUMBER	REV	SHEET
	1	25 of 54
		SIZE A0

Body Controller Left
A,D,J,W X036 X030A X030B X031 X039 X037 X033A X033B X032 X035 X038

Body Controller Right
B,P,I,W X056 X050A X050B X051 X059 X057 X053A X053B X052 X055 X058 X060

HV Battery
B X098 X006 X007

X037-28 High-Side Drive
RESTRAINT_CONTROL_MODULE

X059-30 Pass-through
RESTRAINT_CONTROL_MODULE_PASSTHROUGH_1

X057-1 High-Side Drive
RESTRAINT_CONTROL_MODULE

X059-14 Pass-through
RESTRAINT_CONTROL_MODULE_PASSTHROUGH_2

X057-14 High-Side Drive
HV_CONTACTORS

X055-33 Pass-through
RESTRAINT_CONTROL_MODULE_PASSTHROUGH_2

X055-32 Pass-through
RESTRAINT_CONTROL_MODULE_PASSTHROUGH_1

X098-18 Power In
VEH-12V-CONTACTOR-POWER

X098-13 Digital In
RCM-ENS-IN

X098-8 Power In
VEH-12V-BAT

X098-12 Digital In
PCS Lockout

X098-16 CAN
VEHICLE-CAN-H

X098-15 CAN
VEHICLE-CAN-L

X098-7 CAN-P
CP-CAN-H

X098-6 CAN-N
CP-CAN-L

X098-11 Digital Out
CP-LATCH-EN

X098-10 Digital In
CP-FAULT

X098-1 Analog Out
VEH-HVIL-OUT

X098-3 Analog In
VEH-HVIL-IN

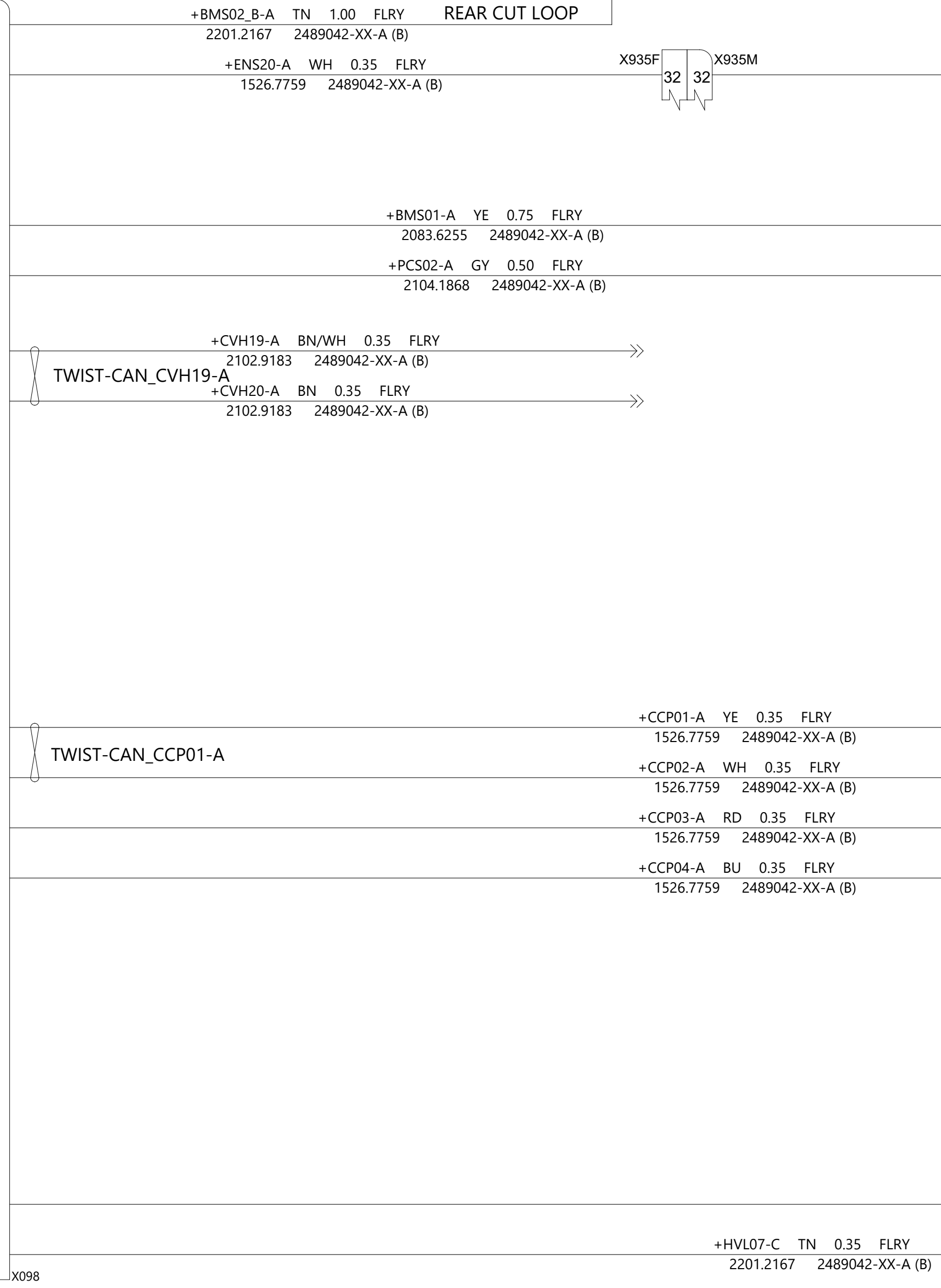
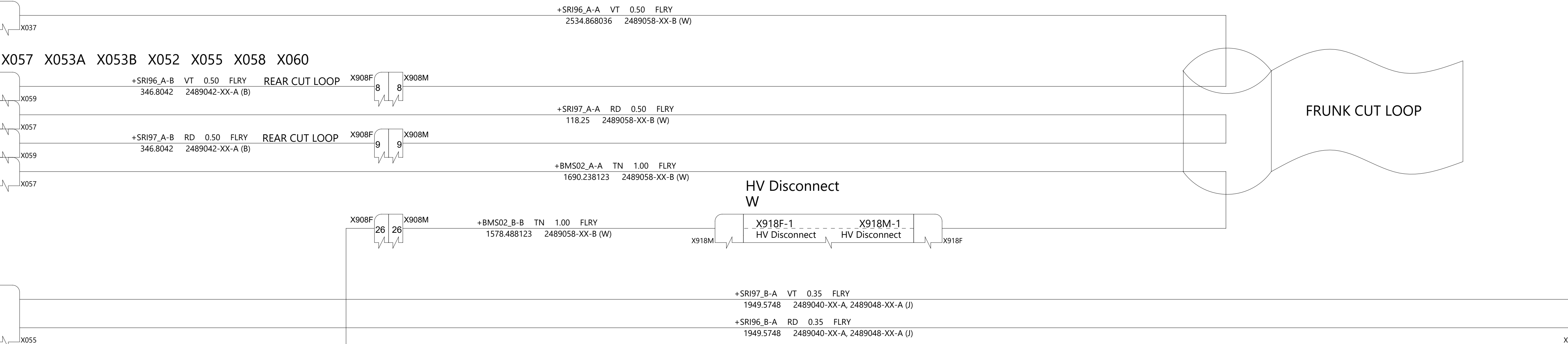

Body Controller Right
B,P,I,W X056 X050A X050B X051 X059 X057 X053A X053B X052 X055 X058 X060

X050B-4 High-Side Drive
HV_CONTROLLER

X057-2 Signal Out
FRONT_EFUSE_LOCKOUT

X051-42 Special
STANDBY_POWER_PCS_LOCKOUT

X057-7 Special
STANDBY_POWER_PCS_LOCKOUT_SWITCHED

X051-43 Special
ECALL_STANDBY_POWER

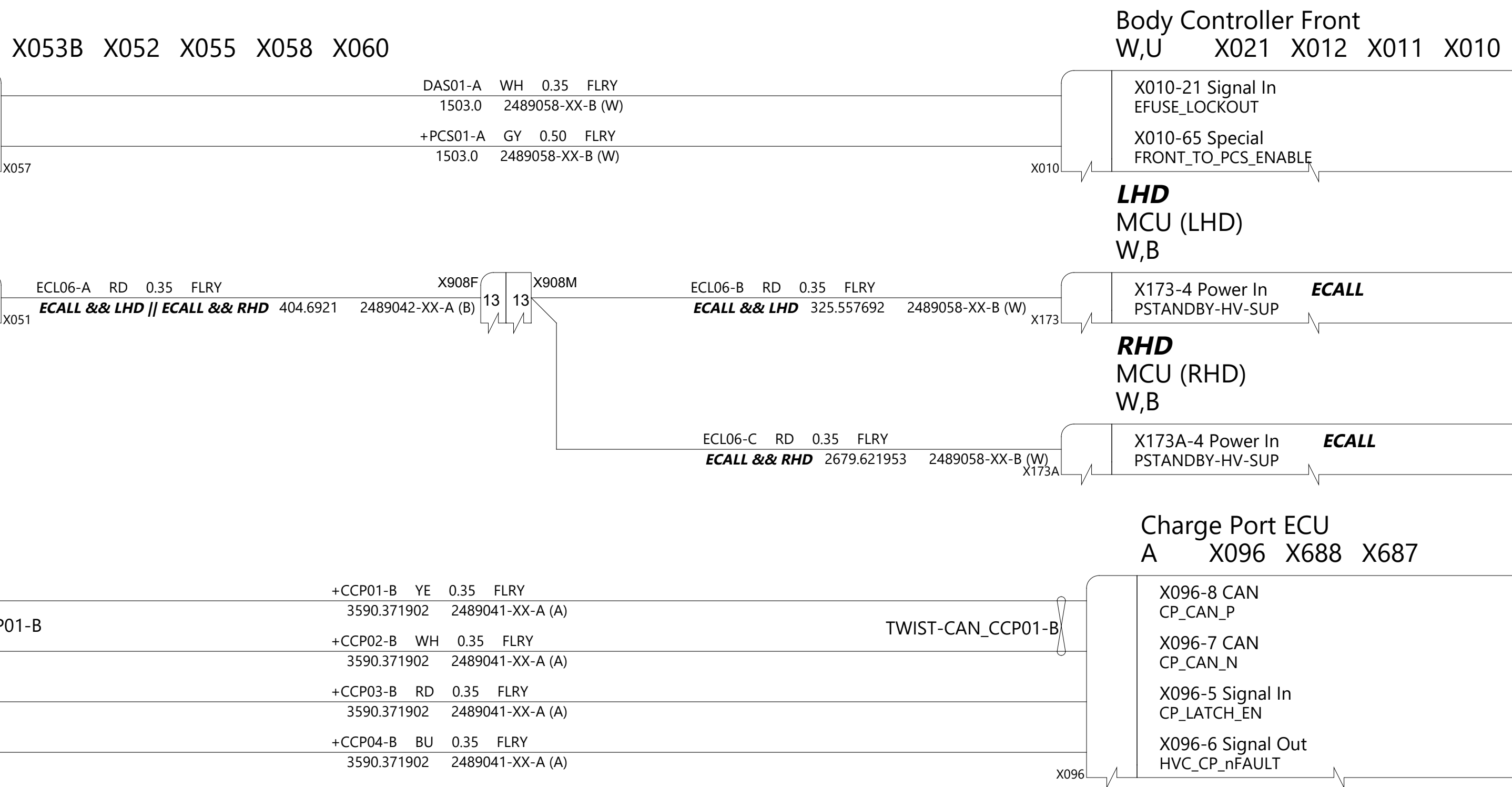

Restraints Controller
A,J X200 X201

X200-27 Power In
PWR2

X200-40 Power In
PWR1

X201-56 Signal Out
ENS1

Body Controller Front
W,U X021 X012 X011 X010 X015 X014

X010-21 Signal In
EFUSE_LOCKOUT

X010-65 Special
FRONT_TO_PCS_ENABLE

LHD
MCU (LHD)
W,B

X173-4 Power In
PSTANDBY-HV-SUP

RHD
MCU (RHD)
W,B

X173A-4 Power In
PSTANDBY-HV-SUP

Charge Port ECU
A X096 X688 X687

X096-8 CAN
CP_CAN_P

X096-7 CAN
CP_CAN_N

X096-5 Signal In
CP_LATCH_EN

X096-6 Signal Out
HVC_CP_nFAULT

Drive Inverter Rear & Resolver
X X090 X091

X090-23 Analog In
HVIL in

X090-4 Analog Out
HVIL out

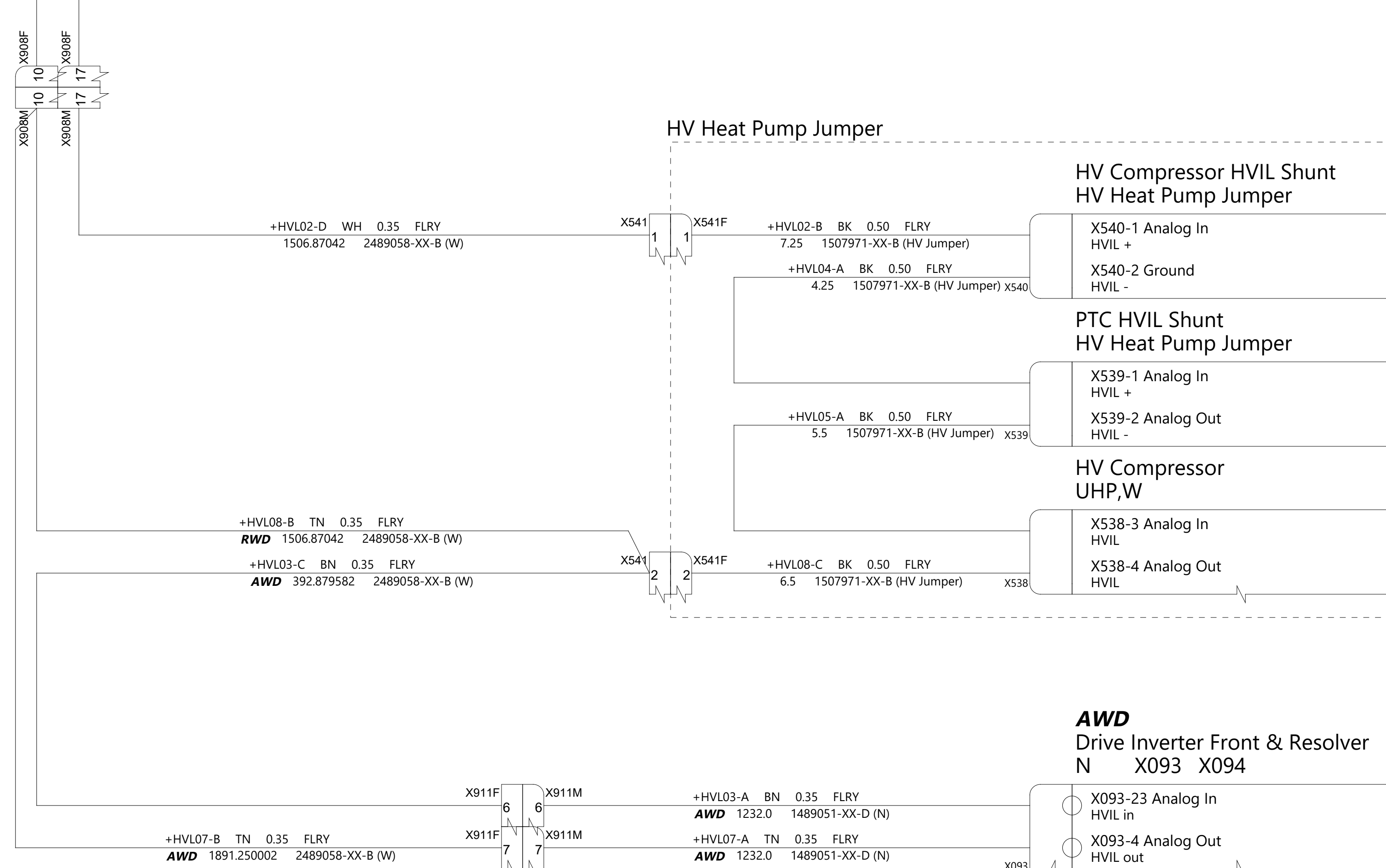

THE INFORMATION CONTAINED HEREIN IS DEEMED TO BE CONFIDENTIAL, PROPRIETARY, AND A TRADE SECRET OF TESLA MOTORS. THIS INFORMATION MAY NOT BE USED, REPRODUCED, OR DISCLOSED AS THE DIRECT OR INDIRECT BASIS FOR THE DEVELOPMENT, MANUFACTURE, OR SALE OF PROCESSES OR PRODUCTS WITHOUT THE EXPRESSED WRITTEN CONSENT OF TESLA MOTORS.

DRAWN	CHECKED	APPROVED
MATERIAL AS SPECIFIED	FINISHING AS SPECIFIED	SCALE NONE
PART NAME HV Battery and HVIL		
PART NUMBER	REV	SHEET
	1	26 OF 54
		SCALE A0

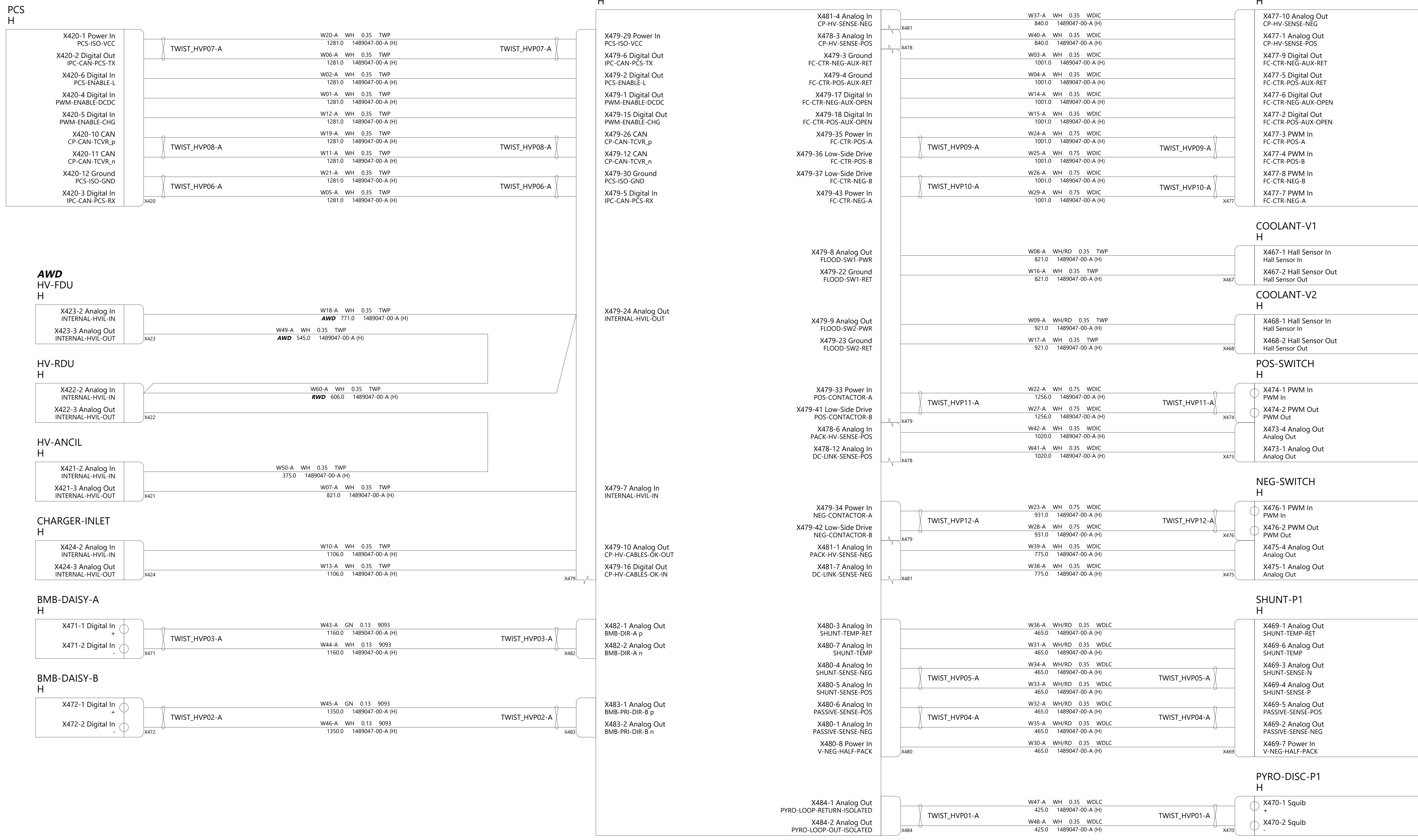

THE INFORMATION CONTAINED HEREIN IS DEEMED TO BE CONFIDENTIAL, PROPRIETARY, AND A TRADE SECRET OF TESLA MOTORS. THIS INFORMATION MAY NOT BE USED, REPRODUCED, OR DISCLOSED AS THE DIRECT OR INDIRECT BASIS FOR THE DEVELOPMENT, MANUFACTURE, OR SALE OF PROCESSES OR PRODUCTS WITHOUT THE EXPRESSED WRITTEN CONSENT OF TESLA MOTORS.

DRAWN	CHECKED	APPROVED
MATERIAL AS SPECIFIED	FINISHING AS SPECIFIED	SCALE NONE
PART NAME HV Penthouse		
PART NUMBER	REV	SHEET
	1	27 OF 54
		SCALE A0

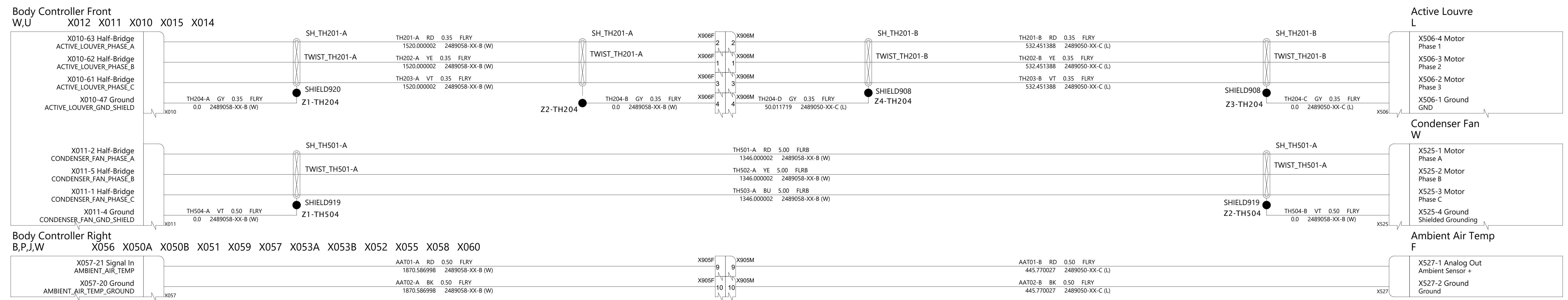

TESLA

THE INFORMATION CONTAINED HEREIN IS DEEMED TO BE CONFIDENTIAL, PROPRIETARY, AND A TRADE SECRET OF TESLA MOTORS. THIS INFORMATION MAY NOT BE USED, REPRODUCED, OR DISCLOSED AS THE DIRECT OR INDIRECT BASIS FOR THE DEVELOPMENT, MANUFACTURE, OR SALE OF PROCESSES OR PRODUCTS WITHOUT THE EXPRESSED WRITTEN CONSENT OF TESLA MOTORS.

DRAWN	CHECKED	APPROVED
MATERIAL AS SPECIFIED	FINISHING AS SPECIFIED	SCALE NONE
PART NAME HVAC - Powertrain		
PART NUMBER	REV	SHEET
	1	28 of 54
		SIZE A0

Battery Coolant Pump UHP

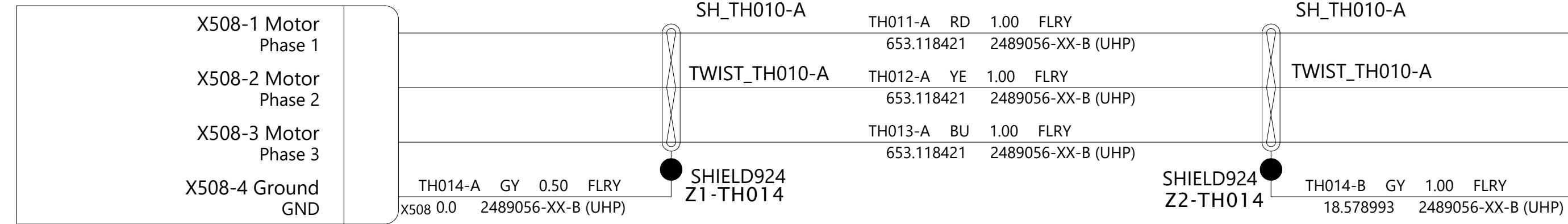

Powertrain Coolant Pump UHP

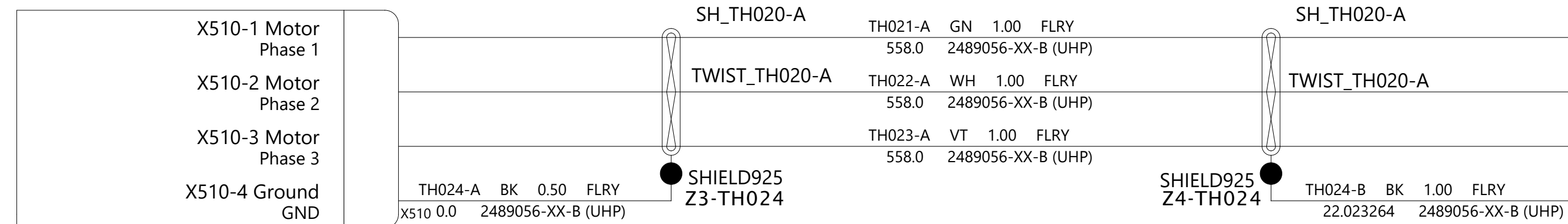

Coolant Temp Sensor - Battery U

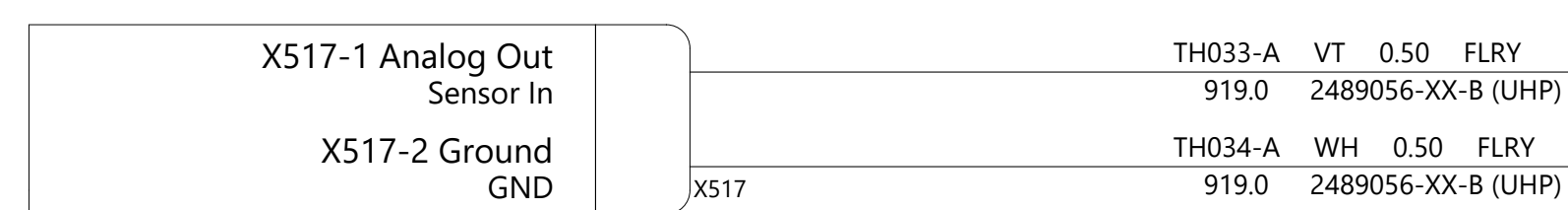

Coolant Temp Sensor - Powertrain U

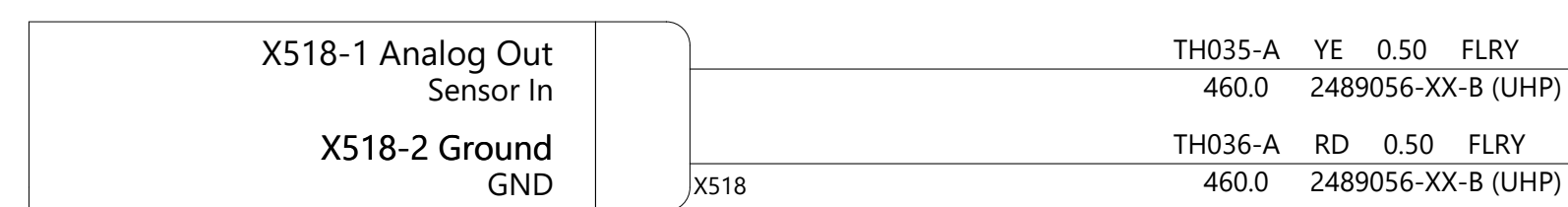

Coolant Level Sensor, Heat Pump UHP

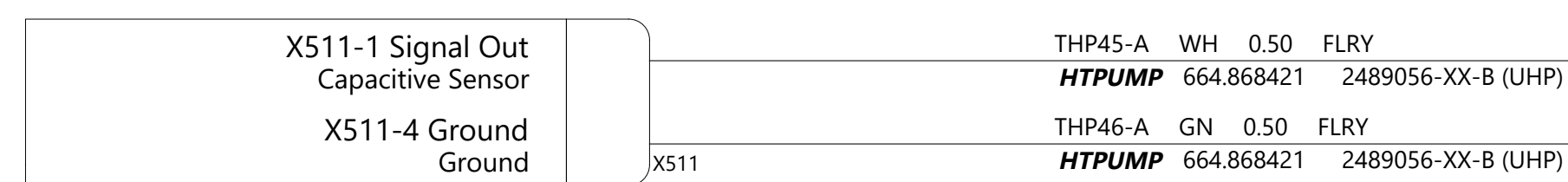

HV Compressor UHP,W

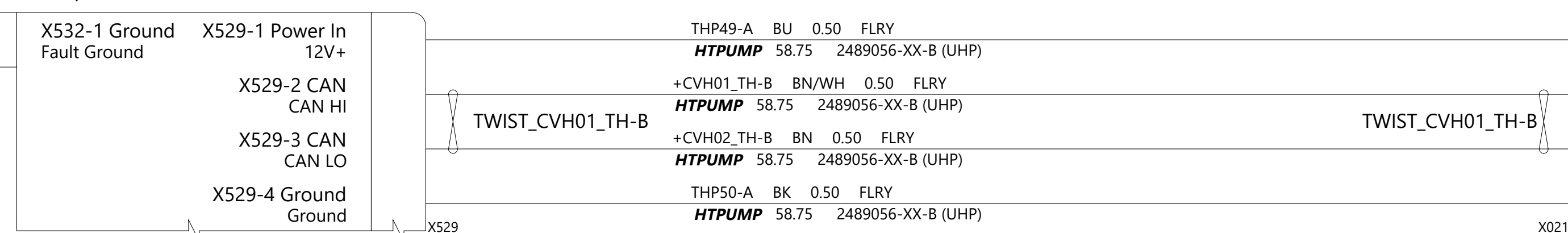

Body Controller Front W,U X012 X011 X010 X015 X014

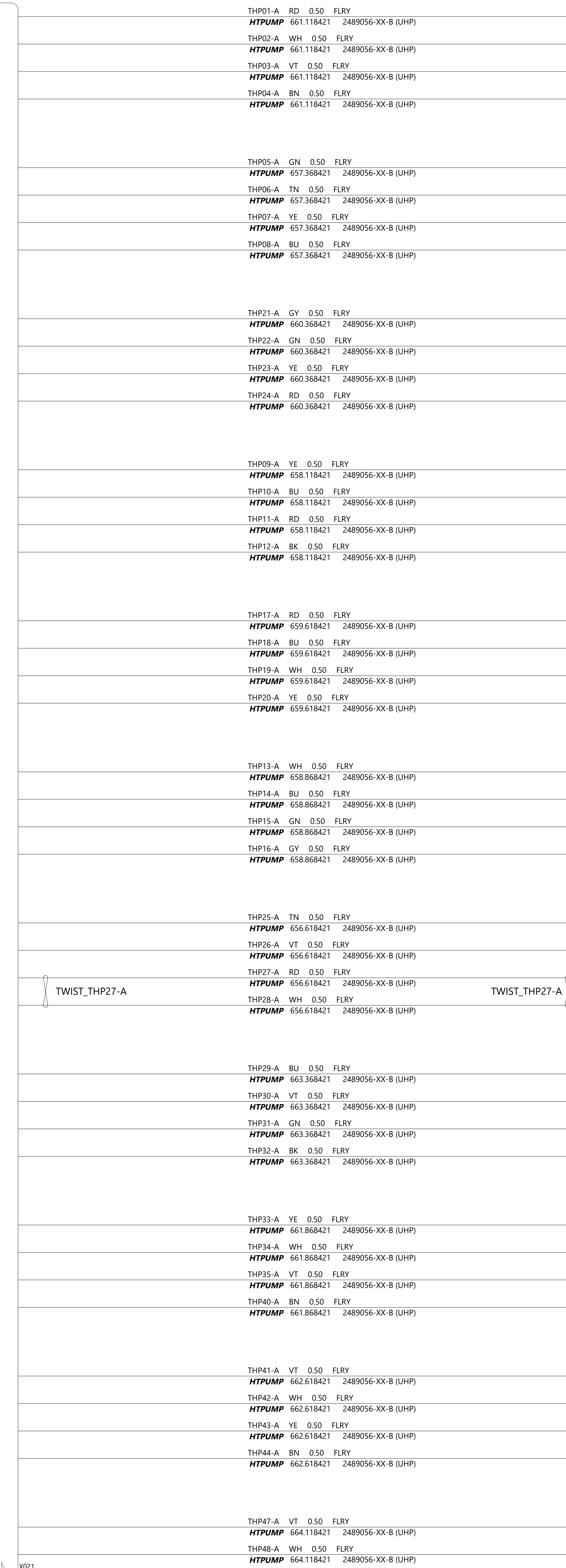
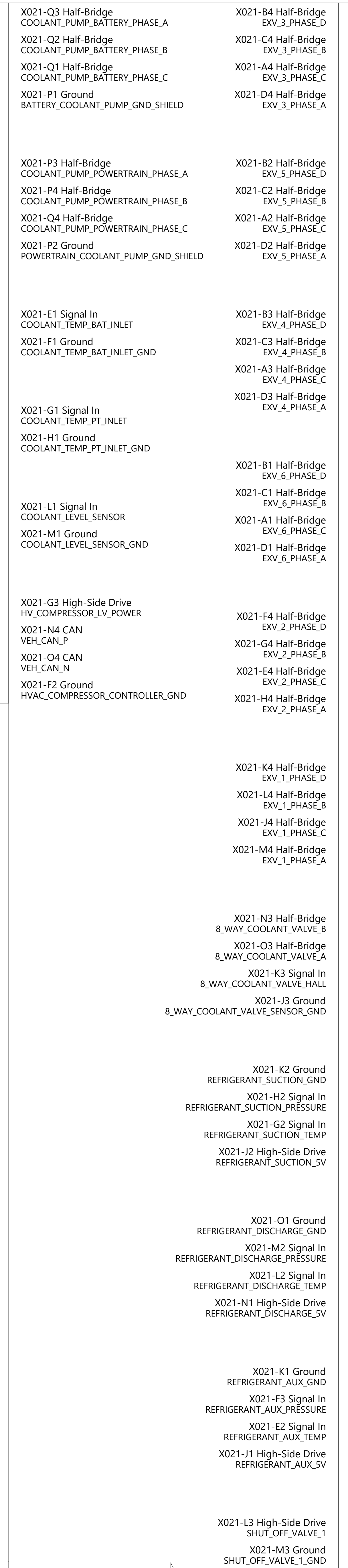

EXV, Recirc UHP

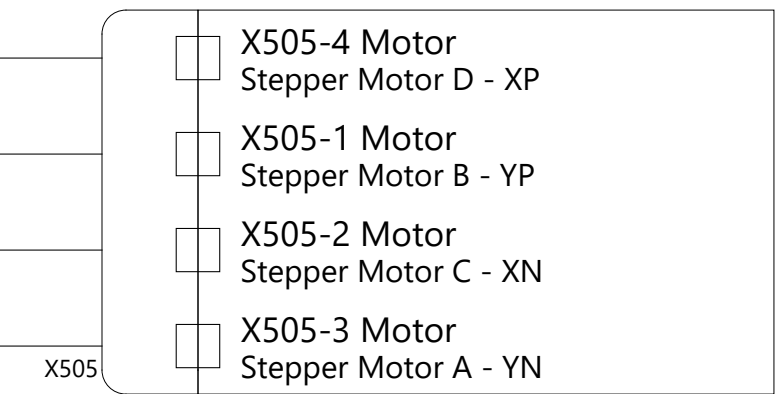

EXV, Cabin Condenser Left UHP

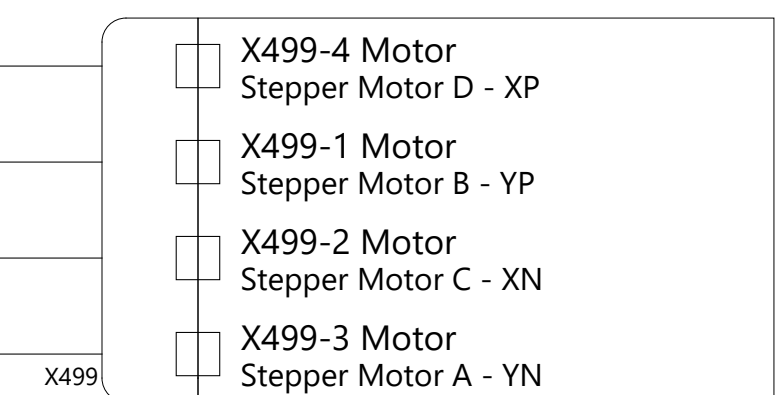

EXV, Liquid Cooled Condenser UHP

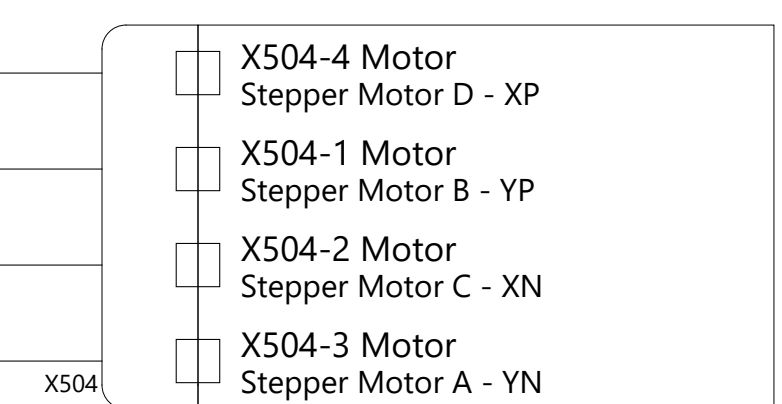

EXV, Cabin Condenser Right UHP

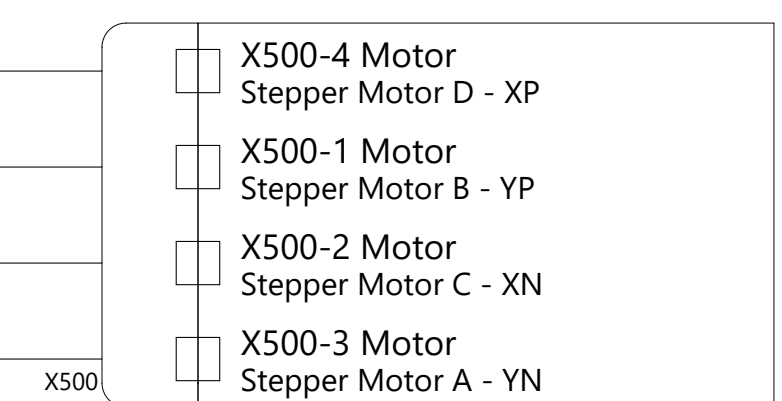

EXV, Evaporator UHP

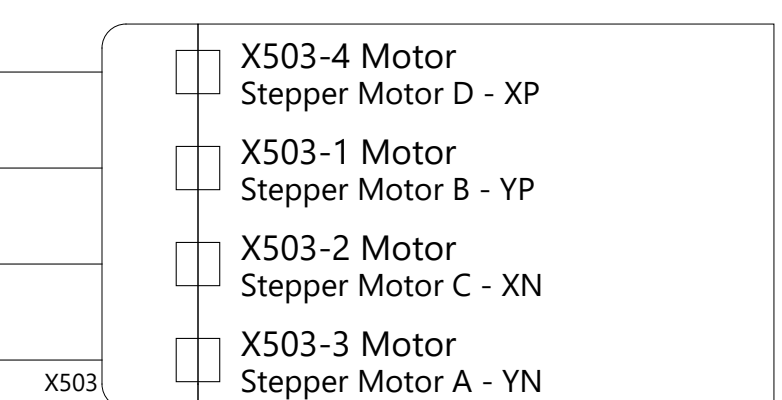

EXV, Chiller UHP

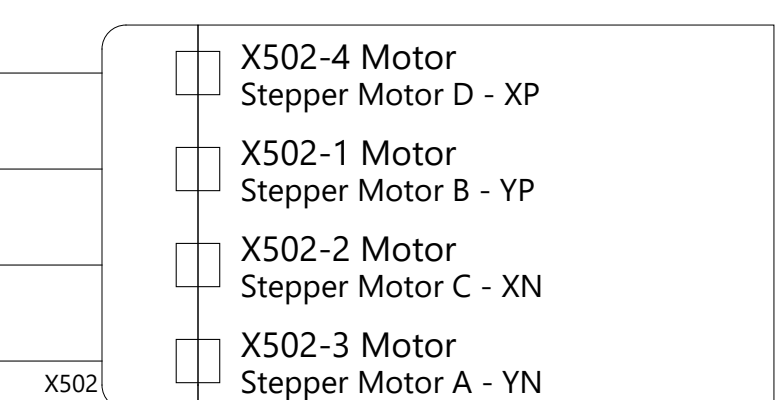

8 Way Coolant Valve UHP

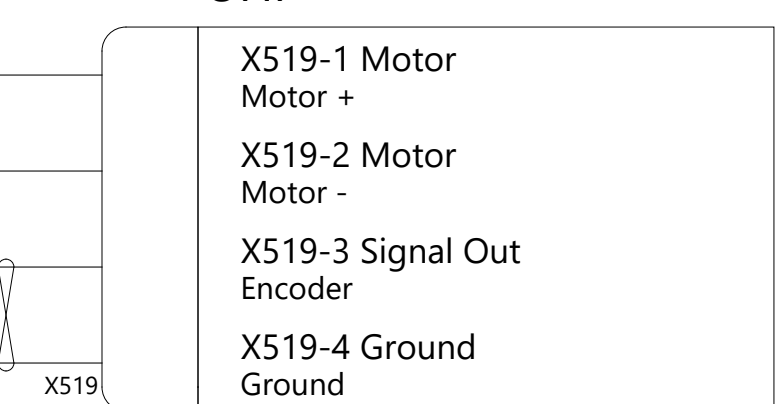

Refrigerant Temp and Pressure Sensor, Suction UHP

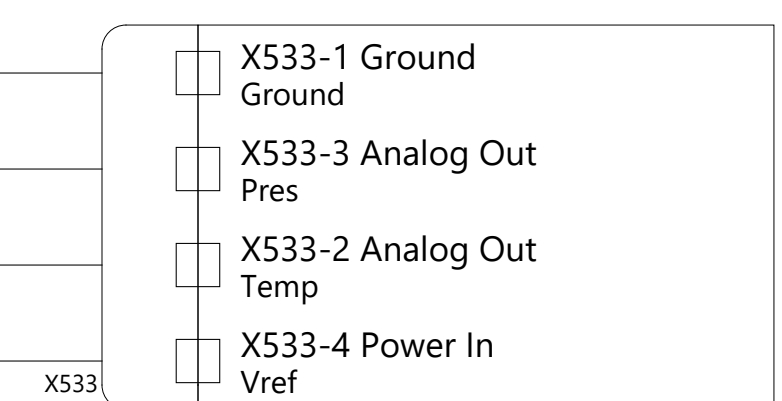

Refrigerant Temp and Pressure Sensor, Discharge UHP

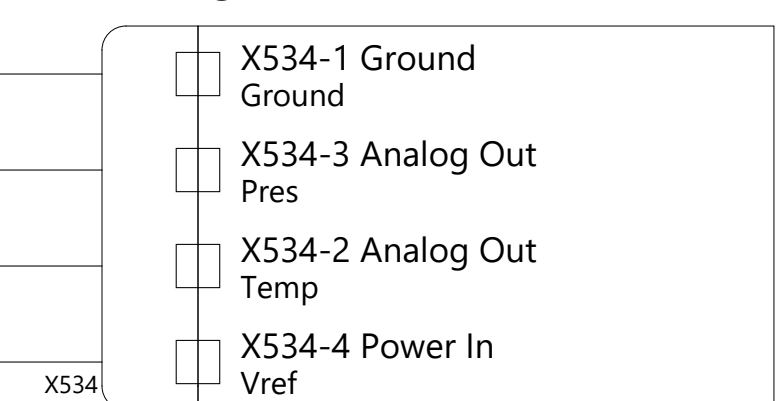

Refrigerant Temp and Pressure Sensor, Subcool UHP

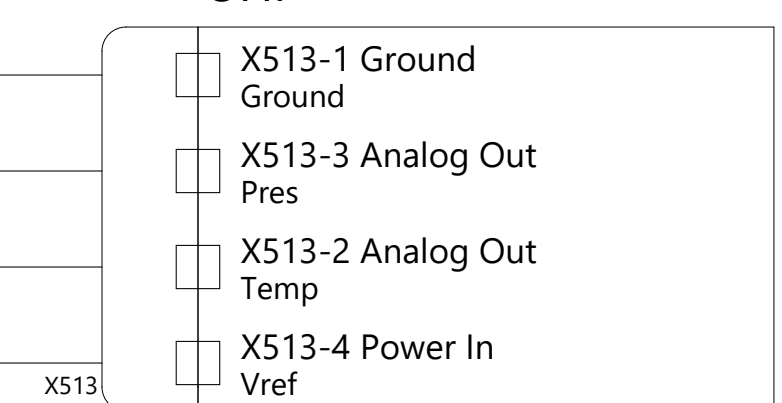

Refrigerant Evap SOV UHP

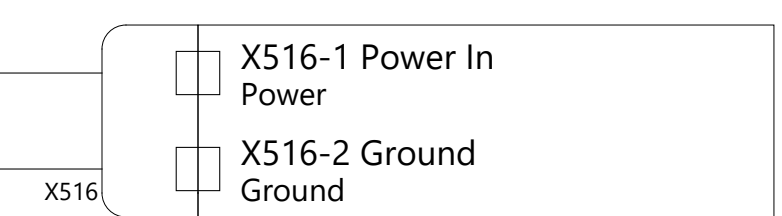

THE INFORMATION CONTAINED HEREIN IS DEEMED TO BE CONFIDENTIAL, PROPRIETARY, AND A TRADE SECRET OF TESLA MOTORS. THIS INFORMATION MAY NOT BE USED, REPRODUCED, OR DISCLOSED AS THE DIRECT OR INDIRECT BASIS FOR THE DEVELOPMENT, MANUFACTURE, OR SALE OF PROCESSES OR PRODUCTS WITHOUT THE EXPRESS WRITTEN CONSENT OF TESLA MOTORS.			
DRAWN	CHECKED	APPROVED	
MATERIAL AS SPECIFIED	FINISHING AS SPECIFIED	SCALE NONE	
PART NAME HVAC Heat Pump			
PART NUMBER	REV	SHEET	SIZE
	1	30 of 54	A0

Body Controller Left
A,D,I,W X036 X030A X030B X031 X039 X037 X033A X033B X032 X035 X038

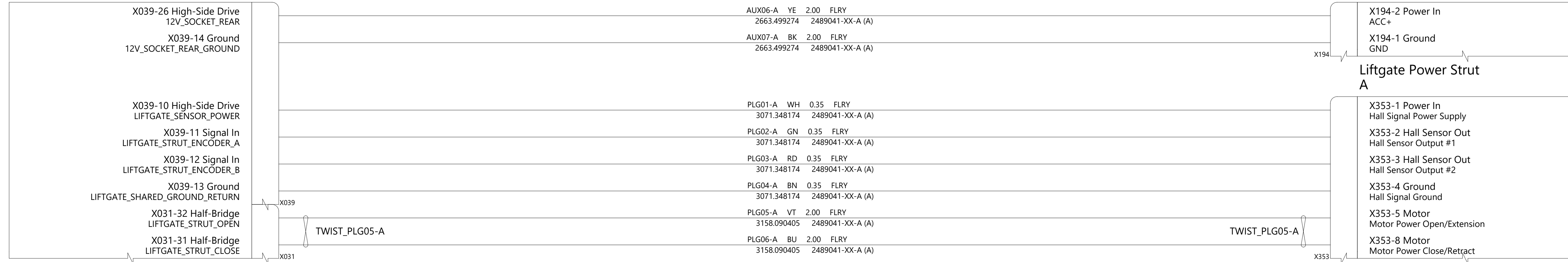

Body Controller Right
B,P,I,W X056 X050A X050B X051 X059 X057 X053A X053B X052 X055 X058 X060

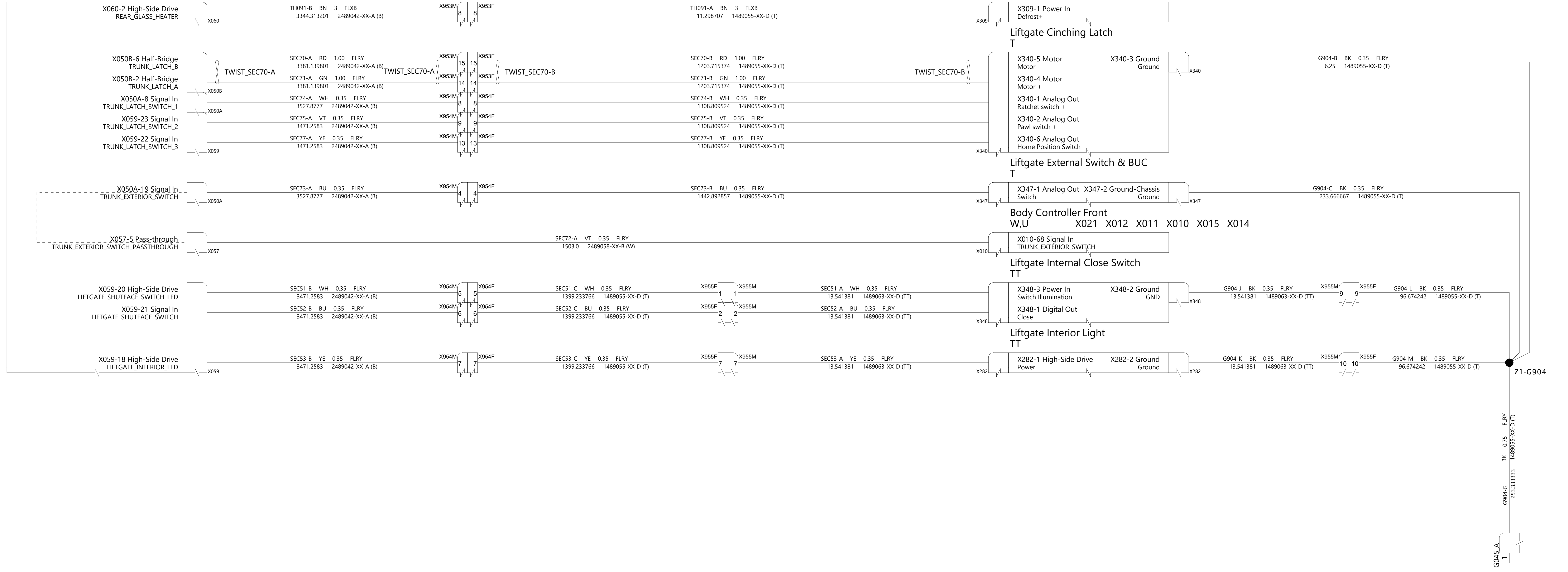

THE INFORMATION CONTAINED HEREIN IS DEEMED TO BE CONFIDENTIAL, PROPRIETARY, AND A TRADE SECRET OF TESLA MOTORS. THIS INFORMATION MAY NOT BE USED, REPRODUCED, OR DISCLOSED AS THE DIRECT OR INDIRECT BASIS FOR THE DEVELOPMENT, MANUFACTURE, OR SALE OF PROCESSES OR PRODUCTS WITHOUT THE EXPRESSED WRITTEN CONSENT OF TESLA MOTORS.

DRAWN	CHECKED	APPROVED

MATERIAL AS SPECIFIED	FINISHING AS SPECIFIED	SCALE NONE
--------------------------	---------------------------	---------------

PART NAME
Liftgate and Trunk

PART NUMBER	REV	SHEET	SIZE
	1	31 OF 54	A0

Body Controller Front
W,U X012 X011 X010 X015 X014

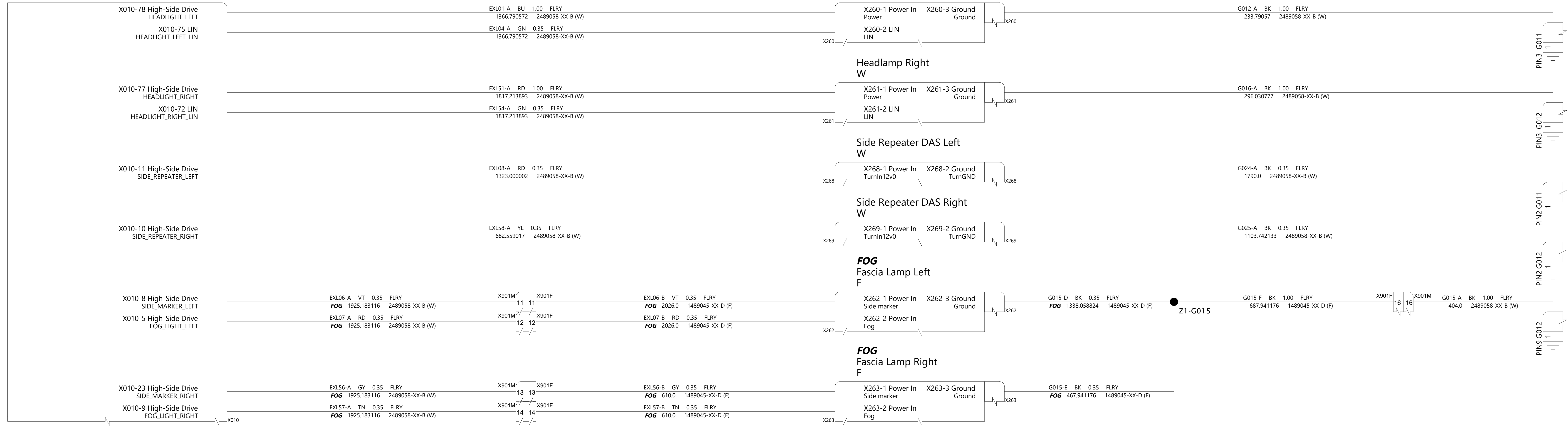

Body Controller Left
A,D,J,W X036 X030A X030B X031 X039 X037 X033A X033B X032 X035 X038

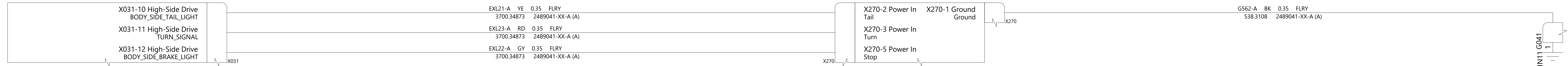

Body Controller Right
B,P,J,W X056 X050A X050B X051 X059 X057 X053A X053B X052 X055 X058 X060

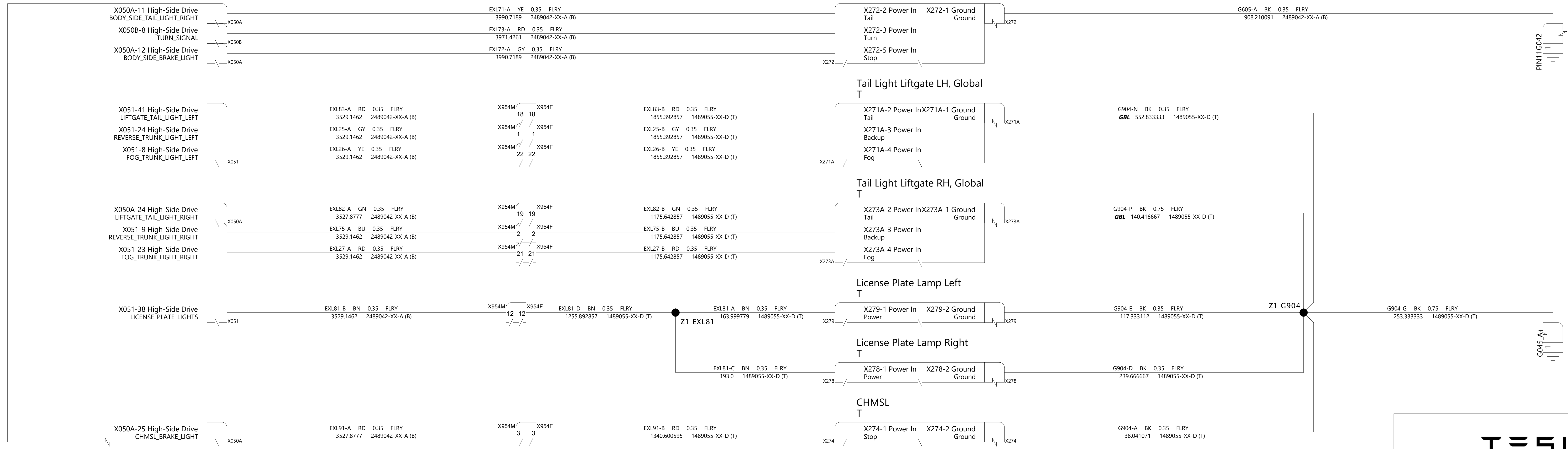

THE INFORMATION CONTAINED HEREIN IS DEEMED TO BE CONFIDENTIAL, PROPRIETARY, AND A TRADE SECRET OF TESLA MOTORS. THIS INFORMATION MAY NOT BE USED, REPRODUCED, OR DISCLOSED AS THE DIRECT OR INDIRECT BASIS FOR THE DEVELOPMENT, MANUFACTURE, OR SALE OF PROCESSES OR PRODUCTS WITHOUT THE EXPRESSED WRITTEN CONSENT OF TESLA MOTORS.

DRAWN	CHECKED	APPROVED
MATERIAL AS SPECIFIED	FINISHING AS SPECIFIED	SCALE NONE
PART NAME Lighting - Exterior		
PART NUMBER	REV 1	SHEET 32 OF 54
		SIZE A0

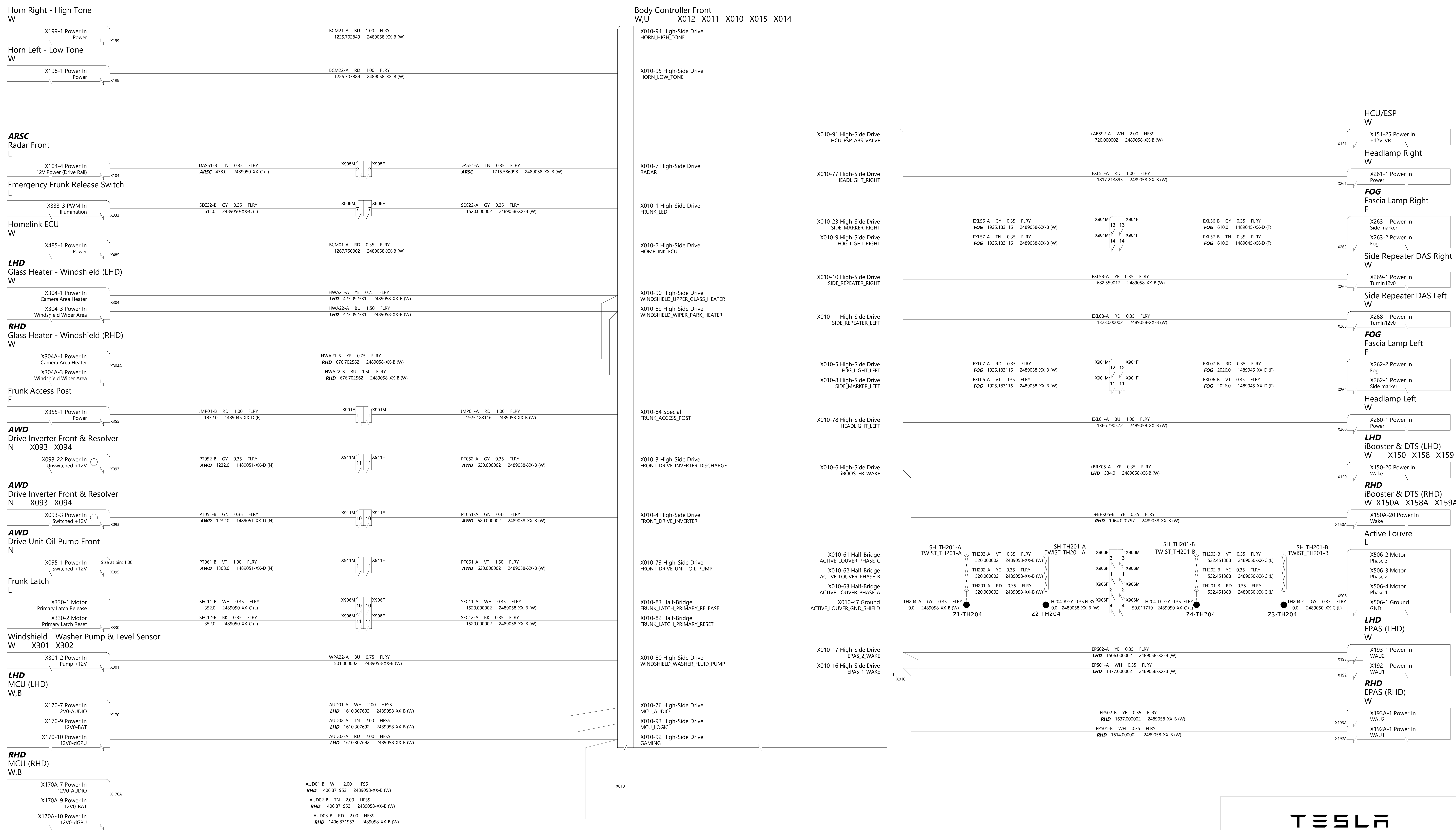

= Shared E-Fuses

THE INFORMATION CONTAINED HEREIN IS DEEMED TO BE CONFIDENTIAL, PROPRIETARY, AND A TRADE SECRET OF TESLA MOTORS. THIS INFORMATION MAY NOT BE USED, REPRODUCED, OR DISCLOSED AS THE DIRECT OR INDIRECT BASIS FOR THE DEVELOPMENT, MANUFACTURE, OR SALE OF PROCESSES OR PRODUCTS WITHOUT THE EXPRESSED WRITTEN CONSENT OF TESLA MOTORS.

DRAWN	CHECKED	APPROVED
MATERIAL AS SPECIFIED	FINISHING AS SPECIFIED	SCALE NONE
PART NAME Power Distribution - VCFront 1/2		
PART NUMBER	REV	SHEET
	1	33 OF 54
		SIZE A0

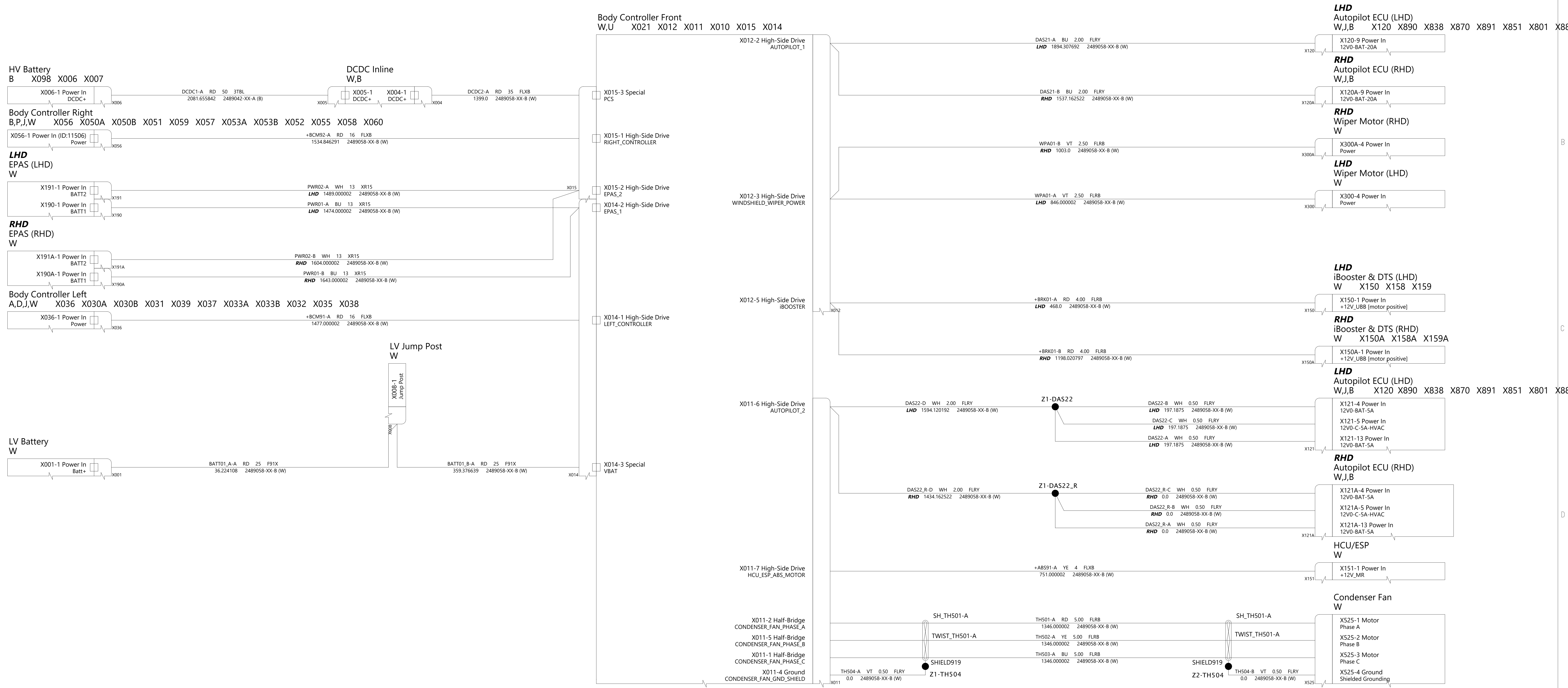

THE INFORMATION CONTAINED HEREIN IS DEEMED TO BE CONFIDENTIAL, PROPRIETARY, AND A TRADE SECRET OF TESLA MOTORS. THIS INFORMATION MAY NOT BE USED, REPRODUCED, OR DISCLOSED AS THE DIRECT OR INDIRECT BASIS FOR THE DEVELOPMENT, MANUFACTURE, OR SALE OF PROCESSES OR PRODUCTS WITHOUT THE EXPRESSED WRITTEN CONSENT OF TESLA MOTORS.

DRAWN	CHECKED	APPROVED
MATERIAL AS SPECIFIED	FINISHING AS SPECIFIED	SCALE NONE
PART NAME Power Distribution - VCFront 2/2		
PART NUMBER	REV	SHEET
	1	34 OF 54
		SIZE A0

Body Controller Right
B,P,J,W X056 X050A X050B X051 X059 X057 X053A X053B X052 X055 X058 X060

Body Controller Left
A,D,J,W X036 X030A X030B X031 X039 X037 X033A X033B X032 X035 X038

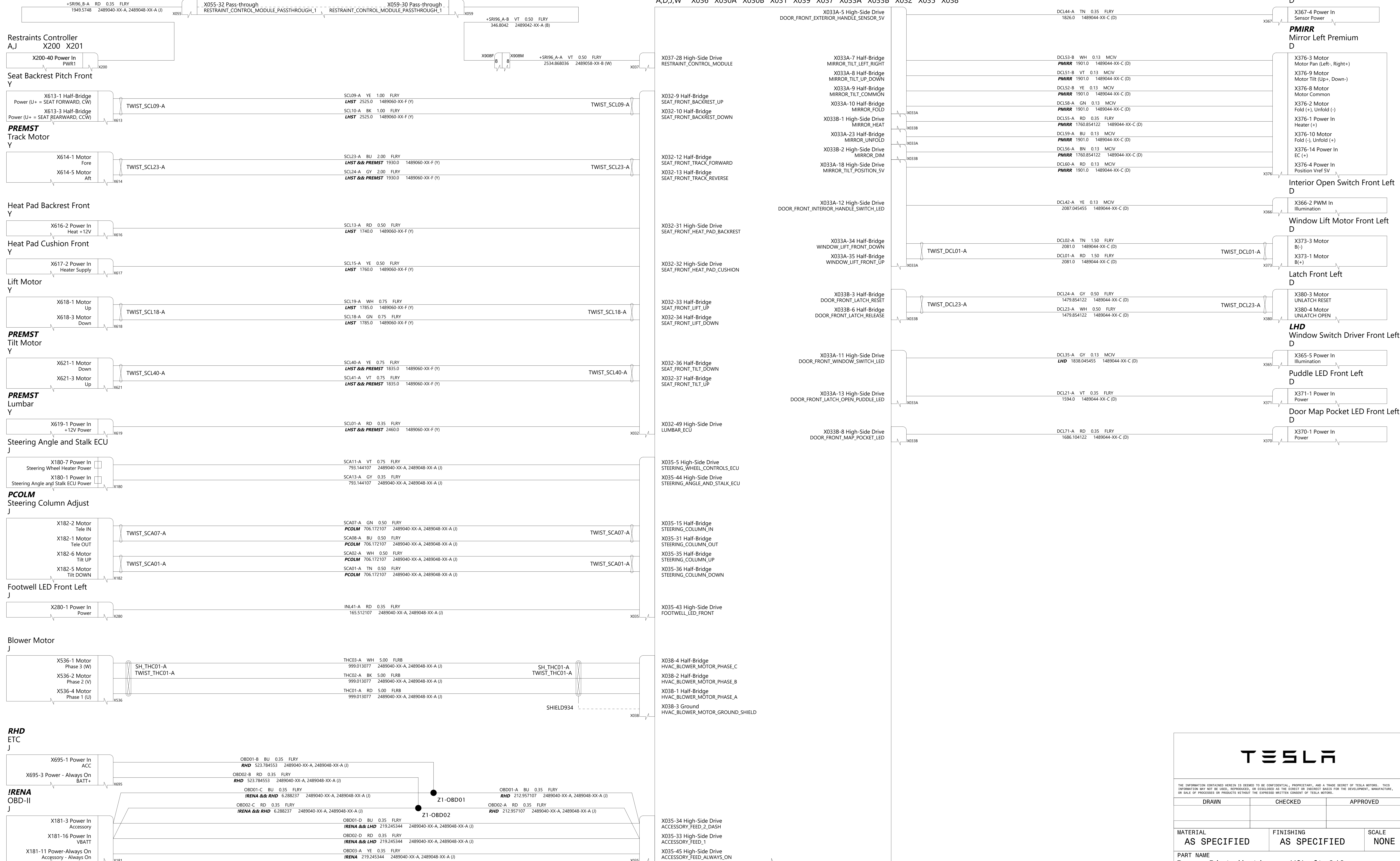

THE INFORMATION CONTAINED HEREIN IS DEEMED TO BE CONFIDENTIAL, PROPRIETARY, AND A TRADE SECRET OF TESLA MOTORS. THIS INFORMATION MAY NOT BE USED, REPRODUCED, OR DISCLOSED AS THE DIRECT OR INDIRECT BASIS FOR THE DEVELOPMENT, MANUFACTURE, OR SALE OF PROCESSES OR PRODUCTS WITHOUT THE EXPRESSED WRITTEN CONSENT OF TESLA MOTORS.			
DRAWN	CHECKED	APPROVED	
MATERIAL AS SPECIFIED	FINISHING AS SPECIFIED	SCALE NONE	
PART NAME Power Distribution - VLeft 2/2			
PART NUMBER	REV	SHEET	SIZE
	1	36 OF 54	A0

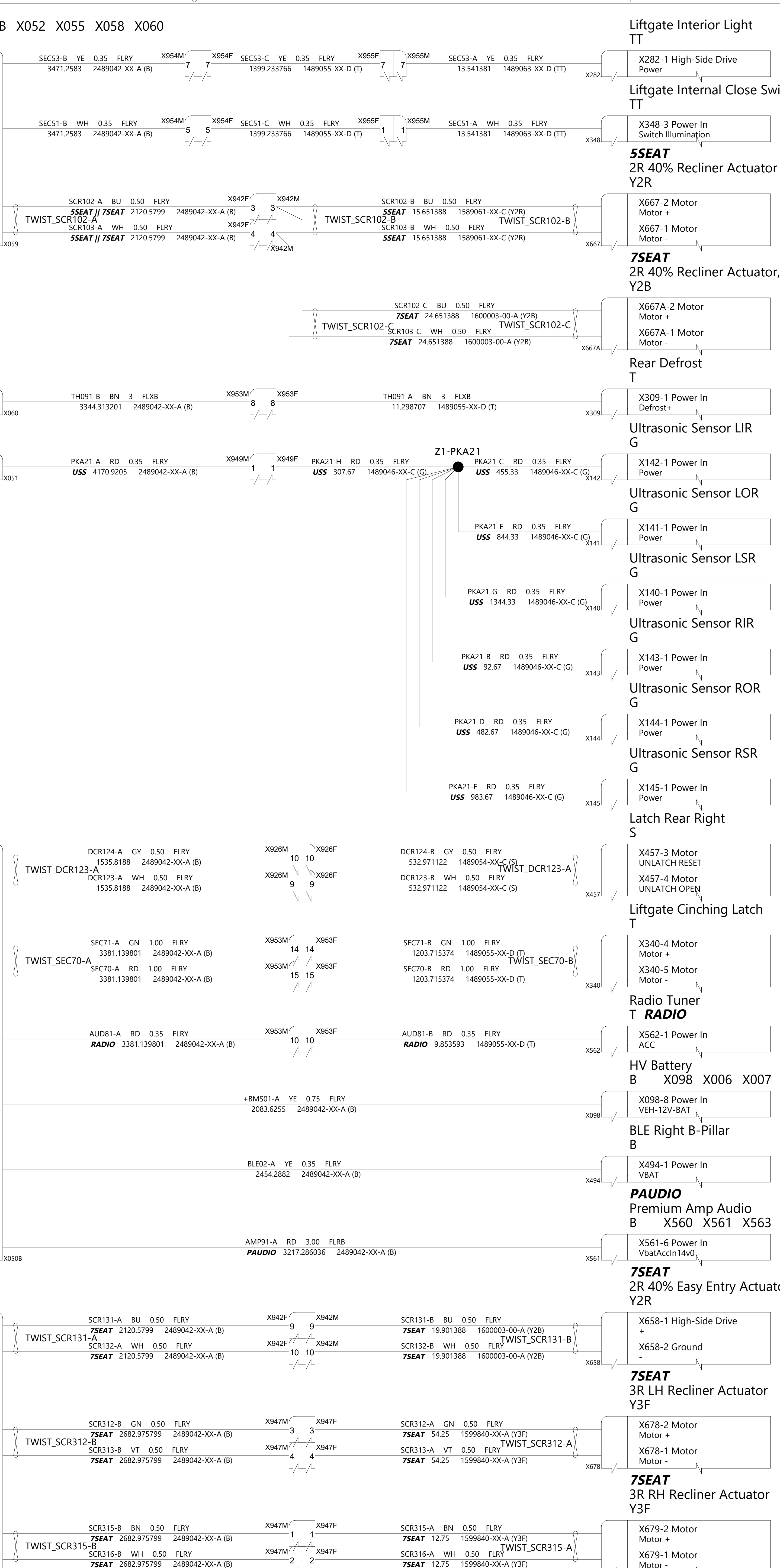
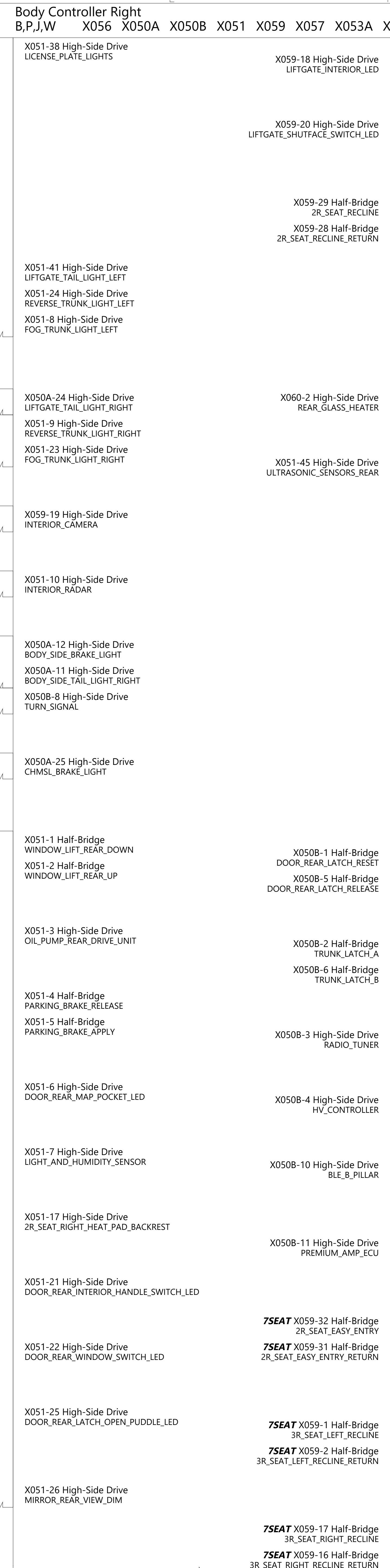
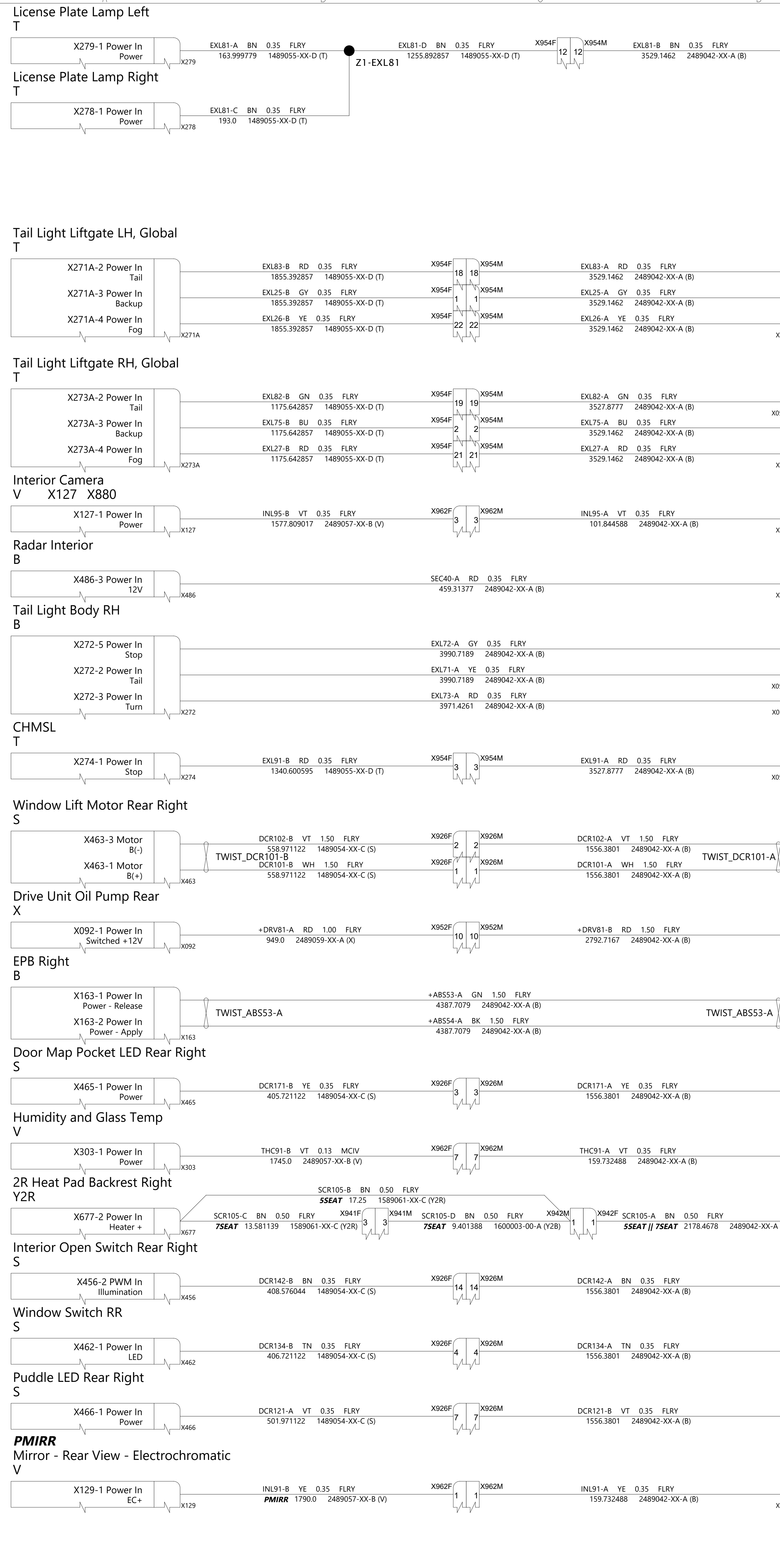

TESLA			
THE INFORMATION CONTAINED HEREIN IS DEEMED TO BE CONFIDENTIAL, PROPRIETARY, AND A TRADE SECRET OF TESLA MOTORS. THIS INFORMATION MAY NOT BE USED, REPRODUCED, OR DISCLOSED AS THE DIRECT OR INDIRECT BASIS FOR THE DEVELOPMENT, MANUFACTURE, OR SALE OF PROCESSES OR PRODUCTS WITHOUT THE EXPRESSED WRITTEN CONSENT OF TESLA MOTORS.			
DRAWN	CHECKED	APPROVED	
MATERIAL AS SPECIFIED		FINISHING AS SPECIFIED	
SCALE NONE			
PART NAME Power Distribution - VCRight 1/2			
PART NUMBER	REV	SHEET	SIZE
	1	37 OF 54	A0

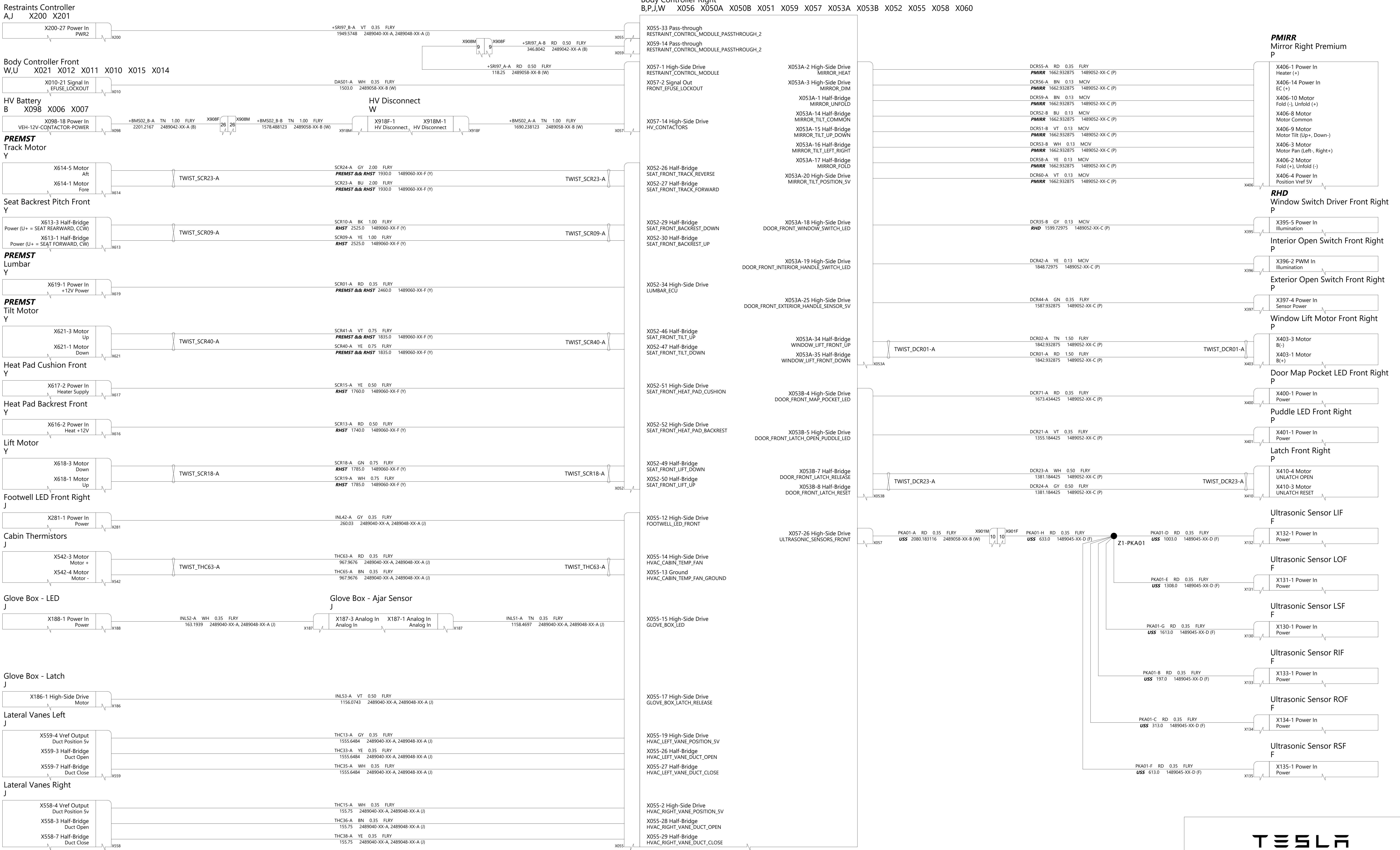

THE INFORMATION CONTAINED HEREIN IS DEEMED TO BE CONFIDENTIAL, PROPRIETARY, AND A TRADE SECRET OF TESLA MOTORS. THIS INFORMATION MAY NOT BE USED, REPRODUCED, OR DISCLOSED AS THE DIRECT OR INDIRECT BASIS FOR THE DEVELOPMENT, MANUFACTURE, OR SALE OF PROCESSES OR PRODUCTS WITHOUT THE EXPRESS WRITTEN CONSENT OF TESLA MOTORS.

DRAWN	CHECKED	APPROVED
MATERIAL AS SPECIFIED	FINISHING AS SPECIFIED	SCALE NONE
PART NAME Power Distribution - VCRight 2/2		
PART NUMBER	REV	SHEET
	1	38 of 54
		SIZE A0

Restraints Controller
A,J X200 X201

Steering Angle and Stalk ECU
J

Airbag - Driver Steering Wheel
J

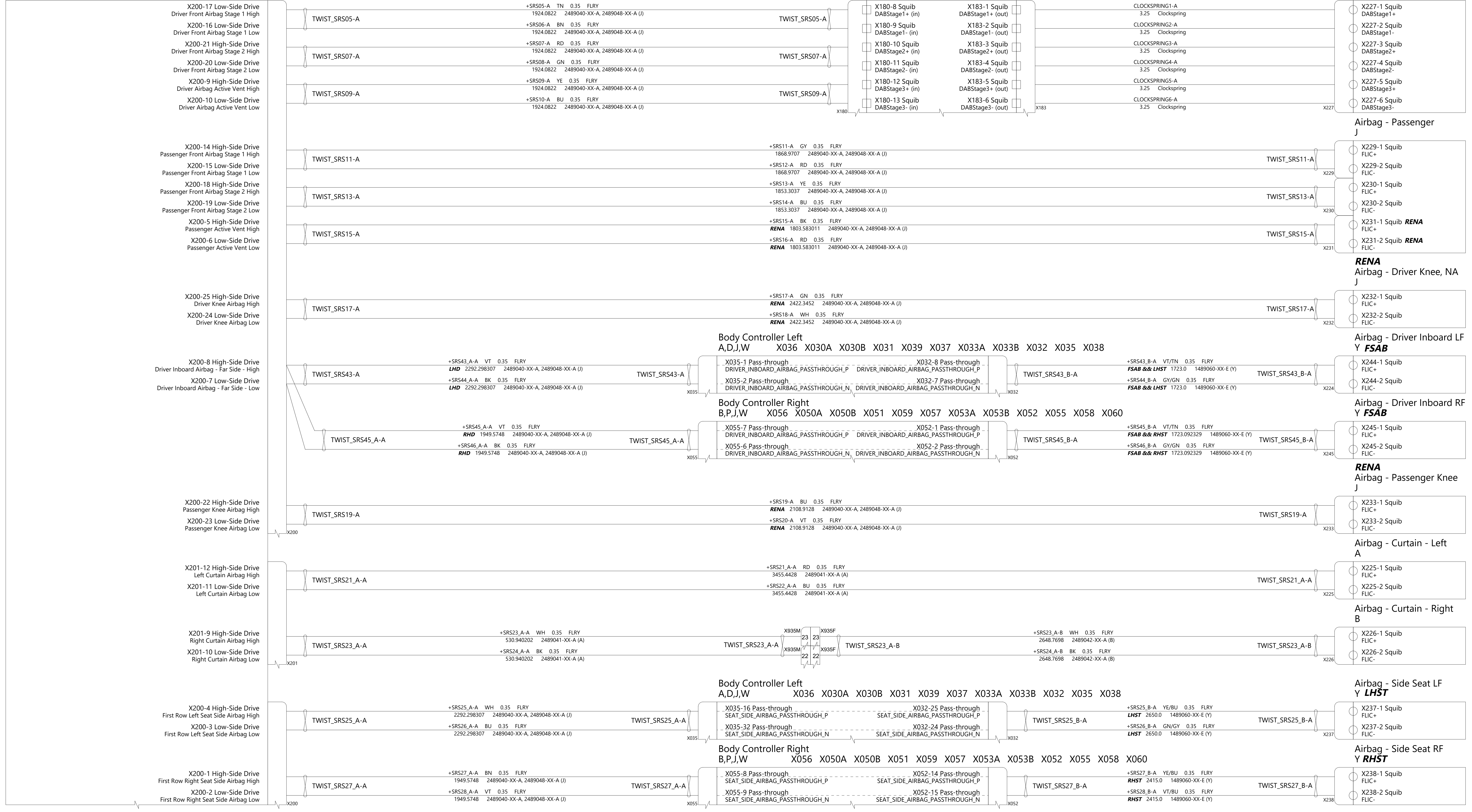

Airbag - Passenger
J

RENA Airbag - Driver Knee, NA
J

Body Controller Left
A,D,J,W X036 X030A X030B X031 X039 X037 X033A X033B X032 X035 X038

Body Controller Right
B,P,J,W X056 X050A X050B X051 X059 X057 X053A X053B X052 X055 X058 X060

Airbag - Driver Inboard LF
Y FSAB

Airbag - Driver Inboard RF
Y FSAB

RENA Airbag - Passenger Knee
J

Airbag - Curtain - Left
A

Airbag - Curtain - Right
B

Body Controller Left
A,D,J,W X036 X030A X030B X031 X039 X037 X033A X033B X032 X035 X038

Body Controller Right
B,P,J,W X056 X050A X050B X051 X059 X057 X053A X053B X052 X055 X058 X060

Airbag - Side Seat LF
Y LHST

Airbag - Side Seat RF
Y RHST



THE INFORMATION CONTAINED HEREIN IS DEEMED TO BE CONFIDENTIAL, PROPRIETARY, AND A TRADE SECRET OF TESLA MOTORS. THIS INFORMATION MAY NOT BE USED, REPRODUCED, OR DISCLOSED AS THE DIRECT OR INDIRECT BASIS FOR THE DEVELOPMENT, MANUFACTURE, OR SALE OF PROCESSES OR PRODUCTS WITHOUT THE EXPRESSED WRITTEN CONSENT OF TESLA MOTORS.

DRAWN	CHECKED	APPROVED
-------	---------	----------

MATERIAL AS SPECIFIED	FINISHING AS SPECIFIED	SCALE NONE
--------------------------	---------------------------	---------------

PART NAME
Restraints - Airbags

PART NUMBER	REV	SHEET	SIZE
	1	39 OF 54	A0

Restraints Controller
A,J X200 X201

X201-4 High-Side Drive
Left Retractor Pretensioner High
X201-3 Low-Side Drive
Left Retractor Pretensioner Low
X201-17 High-Side Drive
First Row Left Seatbelt Load Limiter High
X201-18 Low-Side Drive
First Row Left Seatbelt Load Limiter Low



Body Controller Left
A,D,J,W X036 X030A X030B X031 X039 X037 X033A X033B X032 X035 X038

X200-31 High-Side Drive
First Row Left Outboard Lap Belt Pretensioner High
X200-32 Low-Side Drive
First Row Left Outboard Lap Belt Pretensioner Low

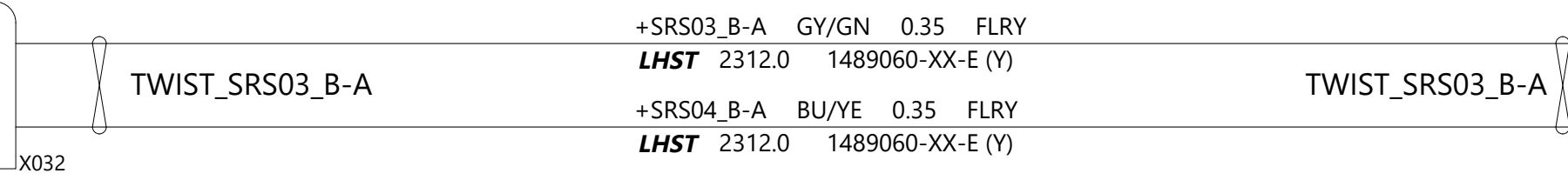
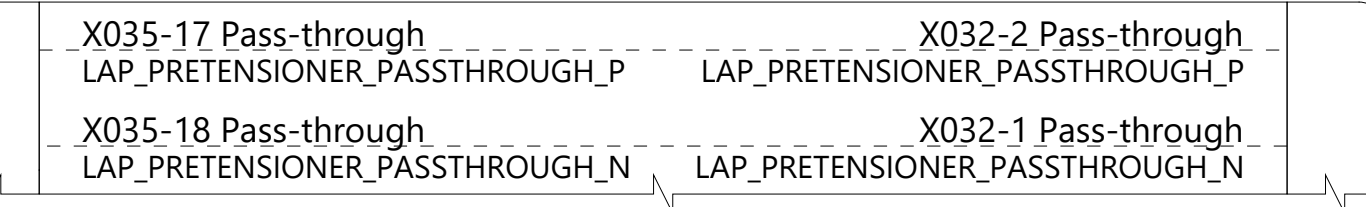
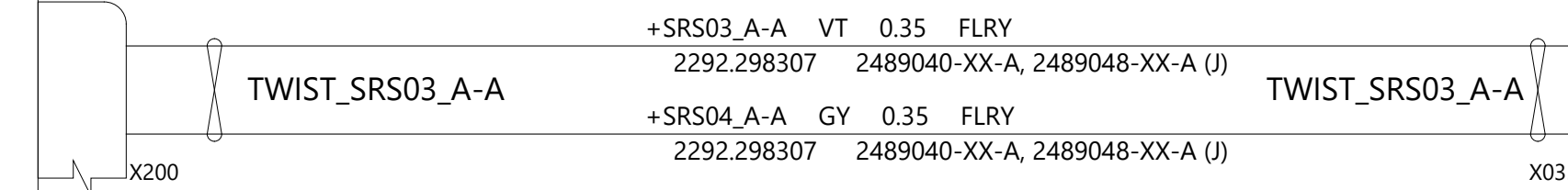

Retractor - LF
A

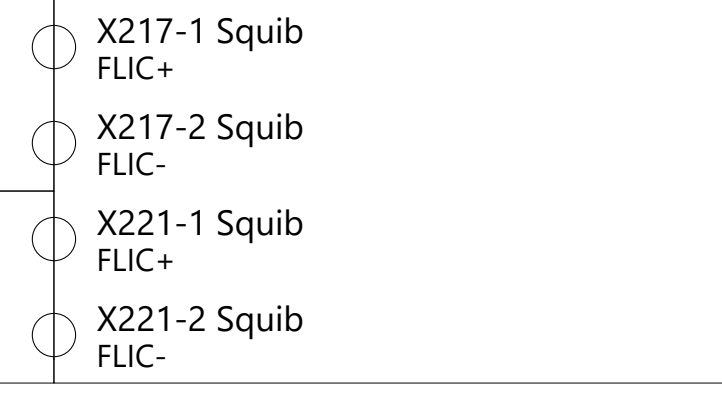

LHST
Lap Pretensioner - LF
Y

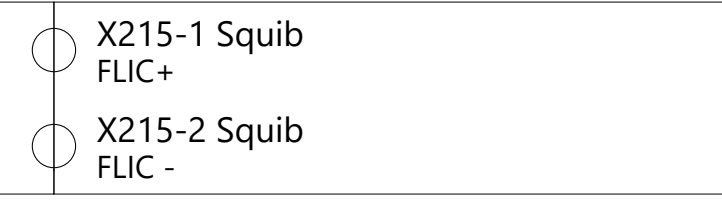

X201-16 High-Side Drive
First Row Right Seatbelt Load Limiter High
X201-15 Low-Side Drive
First Row Right Seatbelt Load Limiter Low
X201-1 High-Side Drive
Right Retractor Pretensioner High
X201-2 Low-Side Drive
Right Retractor Pretensioner Low



Body Controller Right
B,P,J,W X056 X050A X050B X051 X059 X057 X053A X053B X052 X055 X058 X060

X200-34 High-Side Drive
First Row Right Outboard Lap Belt Pretensioner High
X200-33 Low-Side Drive
First Row Right Outboard Lap Belt Pretensioner Low

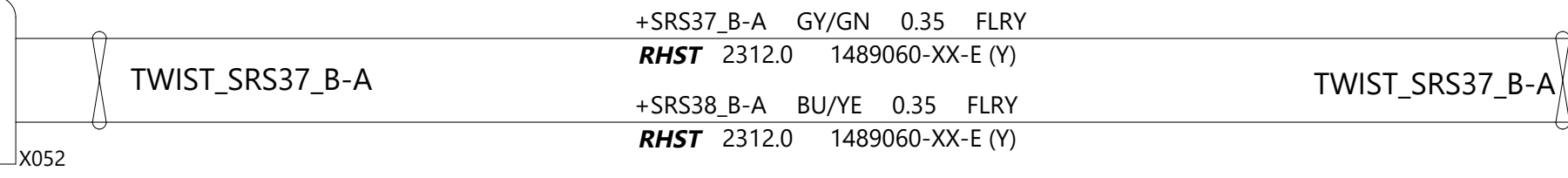
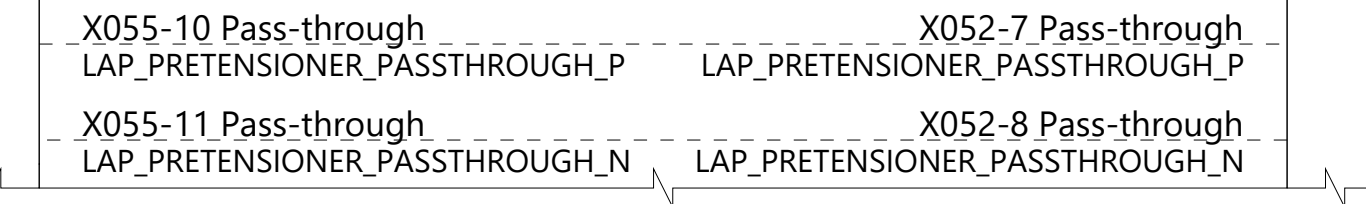
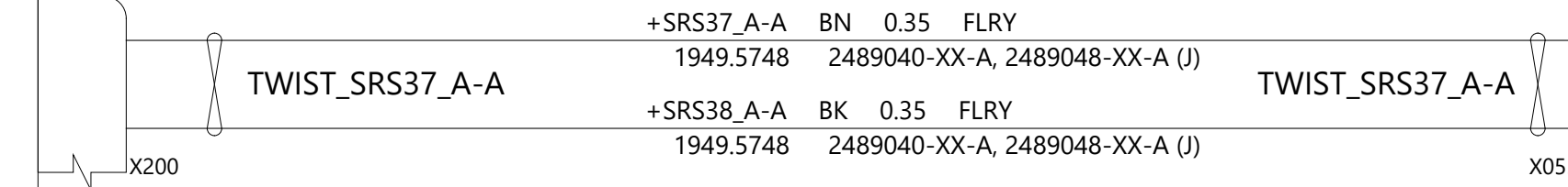

Retractor - RF
B

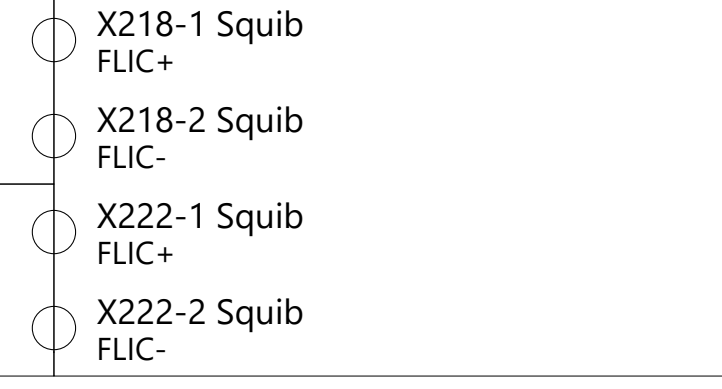

RHST
Lap Pretensioner - RF
Y

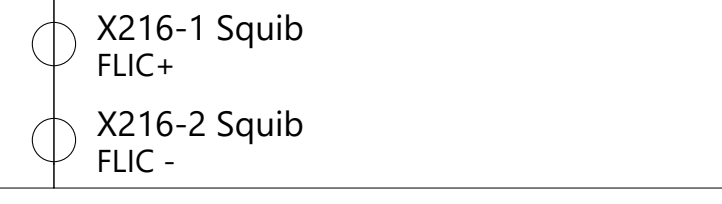

X201-22 High-Side Drive
Second Row Left Outboard Retractor Pretensioner High
X201-21 Low-Side Drive
Second Row Left Outboard Retractor Pretensioner Low

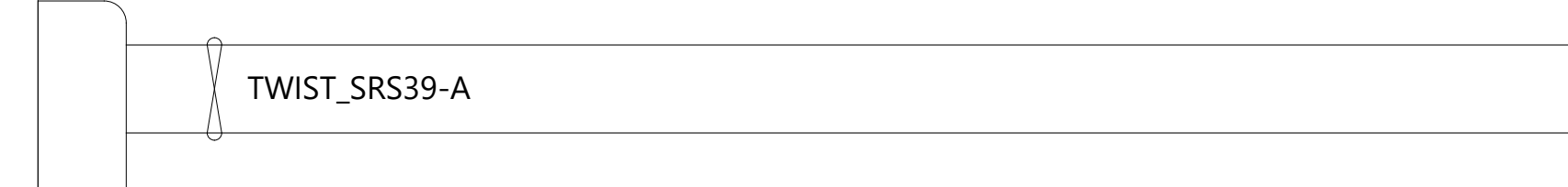

Body Controller Right
B,P,J,W X056 X050A X050B X051 X059 X057 X053A X053B X052 X055 X058 X060

X201-19 High-Side Drive
Second Row Right Outboard Retractor Pretensioner High
X201-20 Low-Side Drive
Second Row Right Outboard Retractor Pretensioner Low

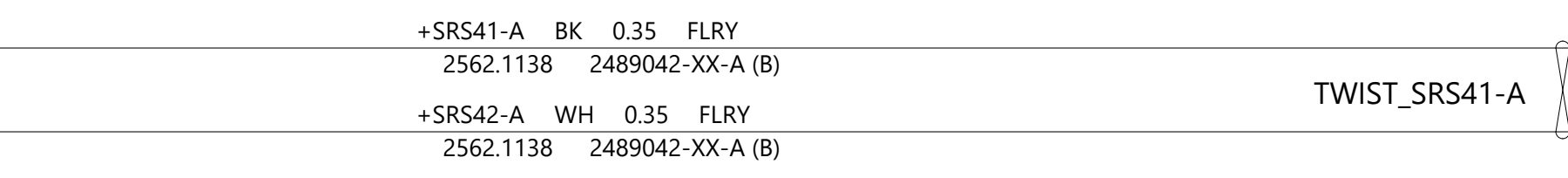
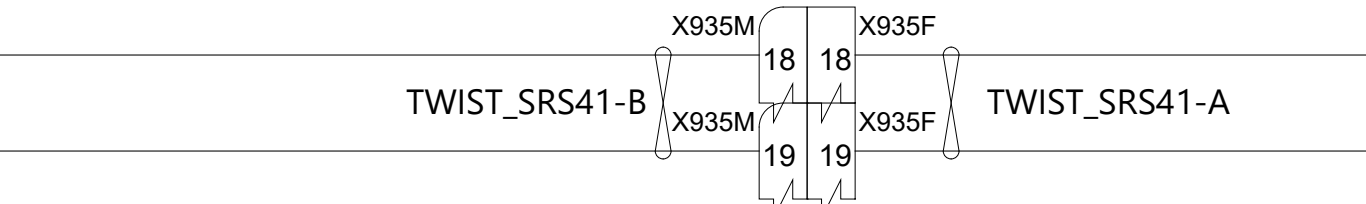
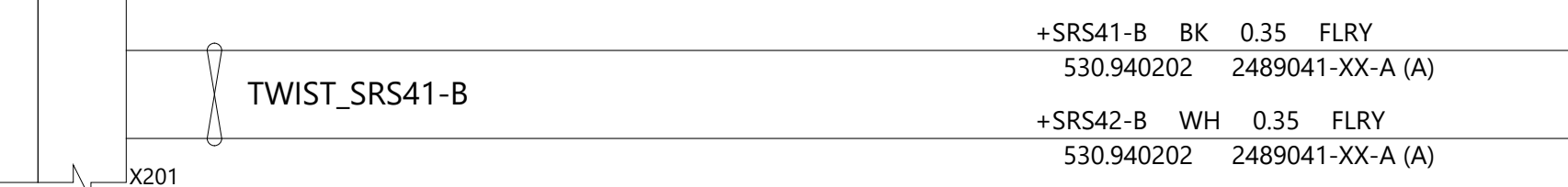

Retractor - LR
A

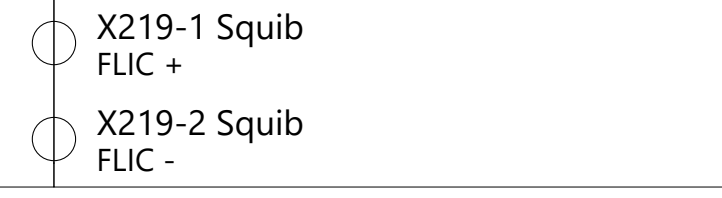

Retractor - RR
B

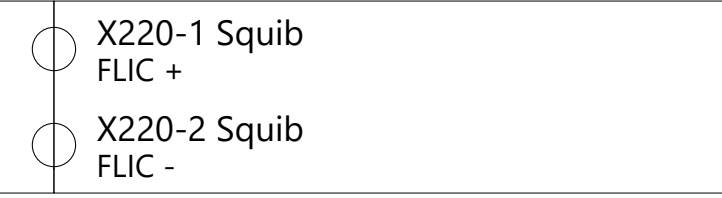

THE INFORMATION CONTAINED HEREIN IS DEEMED TO BE CONFIDENTIAL, PROPRIETARY, AND A TRADE SECRET OF TESLA MOTORS. THIS INFORMATION MAY NOT BE USED, REPRODUCED, OR DISCLOSED AS THE DIRECT OR INDIRECT BASIS FOR THE DEVELOPMENT, MANUFACTURE, OR SALE OF PROCESSES OR PRODUCTS WITHOUT THE EXPRESSED WRITTEN CONSENT OF TESLA MOTORS.

DRAWN	CHECKED	APPROVED
-------	---------	----------

MATERIAL AS SPECIFIED	FINISHING AS SPECIFIED	SCALE NONE
--------------------------	---------------------------	---------------

PART NAME
Restraints - Retractors

PART NUMBER	REV	SHEET	SIZE
	1	40 OF 54	A0

Restraints Controller
A,J X200 X201

Body Controller Right
B,P,J,W X056 X050A X050B X051 X059 X057 X053A X053B X052 X055 X058 X060

LHD
MCU (LHD)
W,B

RHD
MCU (RHD)
W,B

HV Battery
B X098 X006 X007



THE INFORMATION CONTAINED HEREIN IS DEEMED TO BE CONFIDENTIAL, PROPRIETARY, AND A TRADE SECRET OF TESLA MOTORS. THIS INFORMATION MAY NOT BE USED, REPRODUCED, OR DISCLOSED AS THE DIRECT OR INDIRECT BASIS FOR THE DEVELOPMENT, MANUFACTURE, OR SALE OF PRODUCTS OR SERVICES WITHOUT THE EXPRESSED WRITTEN CONSENT OF TESLA MOTORS.

DRAWN	CHECKED	APPROVED
-------	---------	----------

MATERIAL AS SPECIFIED	FINISHING AS SPECIFIED	SCALE NONE
--------------------------	---------------------------	---------------

PART NAME
Restraints - Sensors

PART NUMBER	REV	SHEET	SIZE
	1	41 OF 54	A0

LHD
MCU (LHD)
W,B

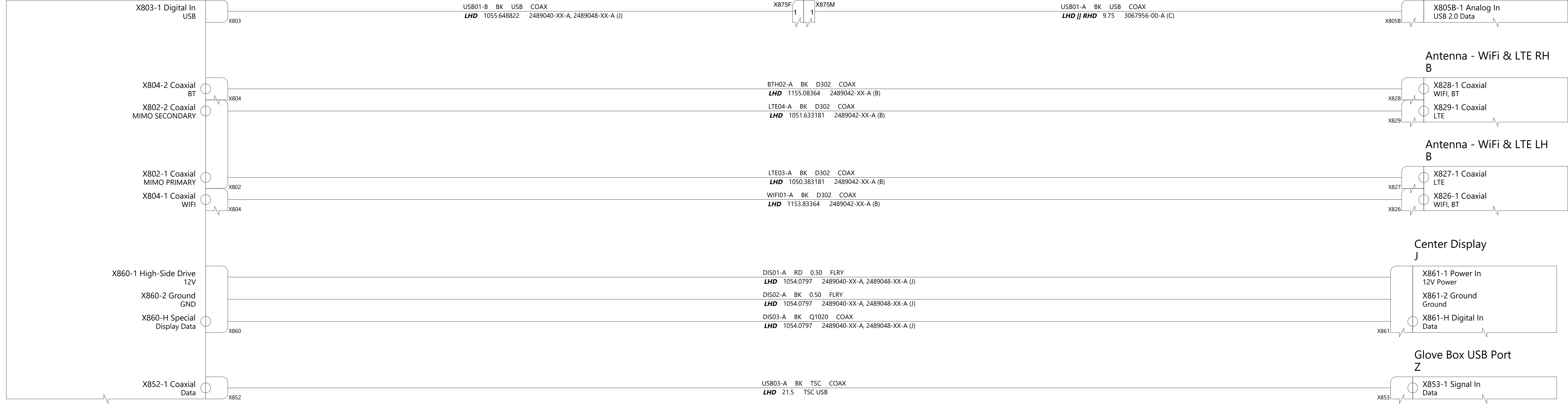

LHD
Autopilot ECU (LHD)
W,J,B X120 X890 X838 X870 X891 X851 X801 X881 X830 X121

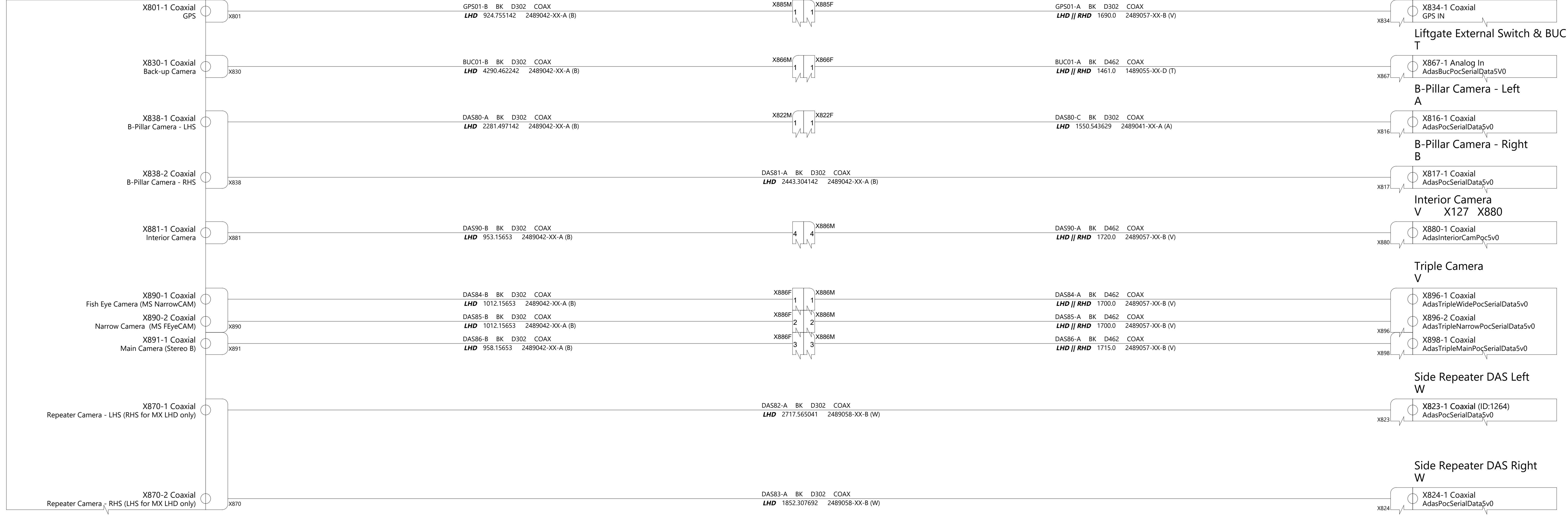

RADIO
Radio Tuner
T

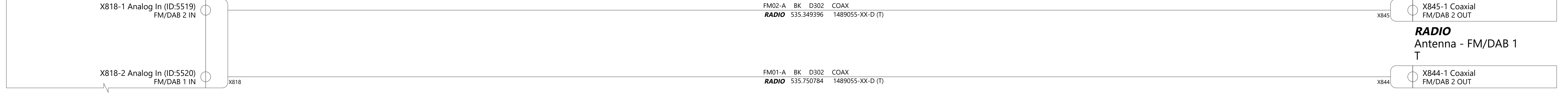

THE INFORMATION CONTAINED HEREIN IS DEEMED TO BE CONFIDENTIAL, PROPRIETARY, AND A TRADE SECRET OF TESLA MOTORS. THIS INFORMATION MAY NOT BE USED, REPRODUCED, OR DISCLOSED AS THE DIRECT OR INDIRECT BASIS FOR THE DEVELOPMENT, MANUFACTURE, OR SALE OF PROCESSES OR PRODUCTS WITHOUT THE EXPRESSED WRITTEN CONSENT OF TESLA MOTORS.

DRAWN	CHECKED	APPROVED
MATERIAL AS SPECIFIED	FINISHING AS SPECIFIED	SCALE NONE
PART NAME RF/Special Cables		
PART NUMBER	REV	SHEET
	1	42 of 54
		SIZE A0

RHD
MCU (RHD)
W,B

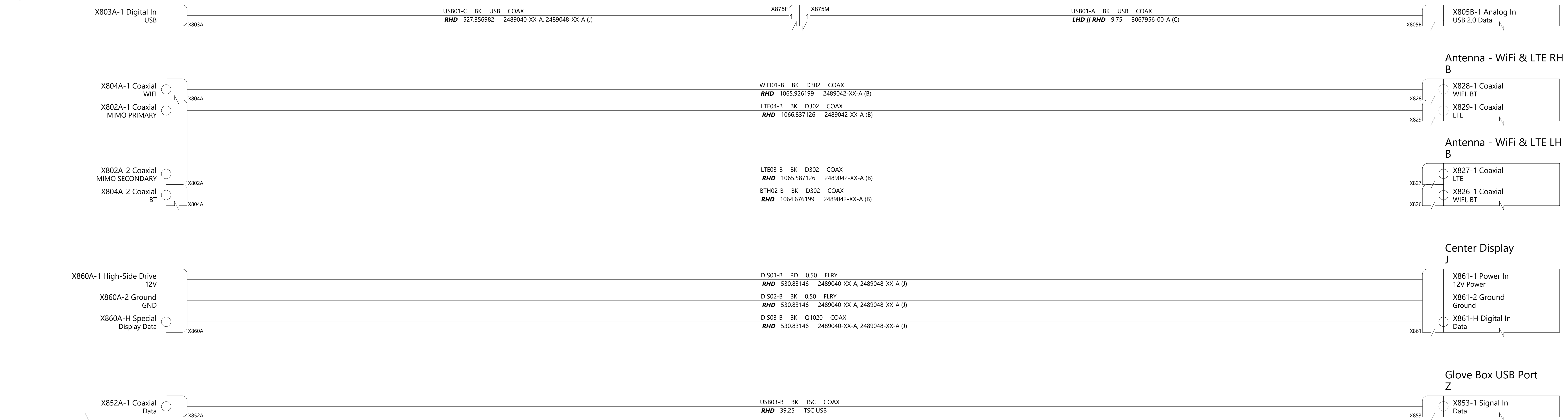

RHD
Autopilot ECU (RHD)
W,J,B

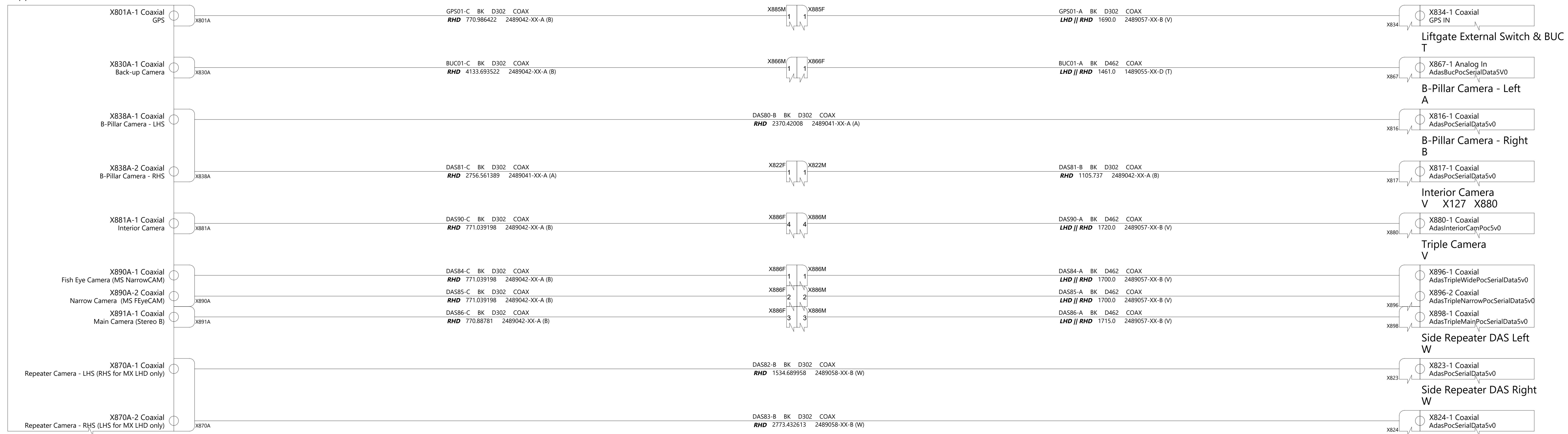

TESLA

THE INFORMATION CONTAINED HEREIN IS DEEMED TO BE CONFIDENTIAL, PROPRIETARY, AND A TRADE SECRET OF TESLA MOTORS. THIS INFORMATION MAY NOT BE USED, REPRODUCED, OR DISCLOSED AS THE DIRECT OR INDIRECT BASIS FOR THE DEVELOPMENT, MANUFACTURE, OR SALE OF PROCESSES OR PRODUCTS WITHOUT THE EXPRESSED WRITTEN CONSENT OF TESLA MOTORS.

DRAWN	CHECKED	APPROVED

MATERIAL AS SPECIFIED	FINISHING AS SPECIFIED	SCALE NONE
--------------------------	---------------------------	---------------

PART NAME
RF/Special Cables, RHD

PART NUMBER	REV	SHEET	SIZE
	1	43 OF 54	A0

Body Controller Left
A,D,J,W X036 X030A X030B X031

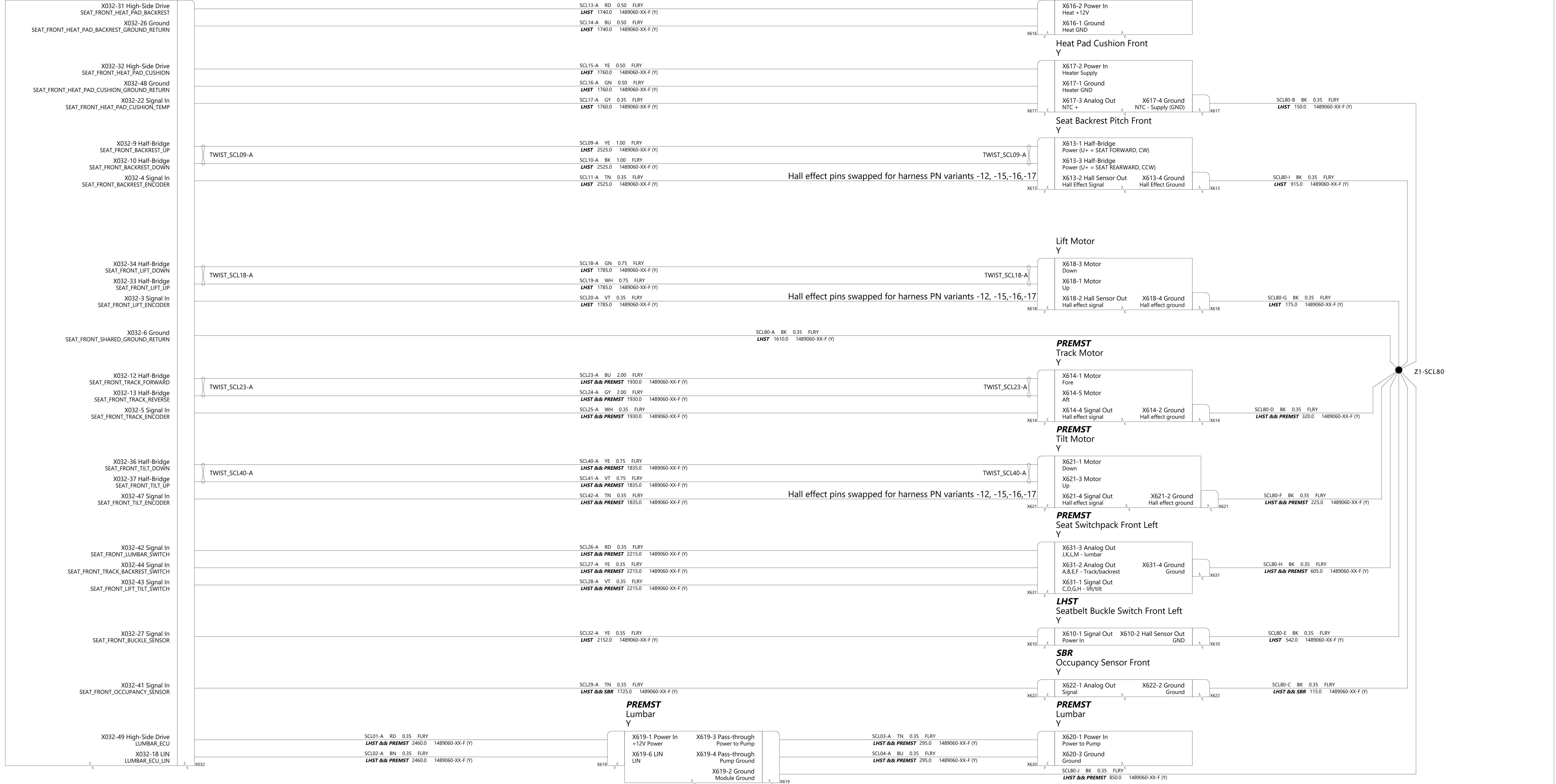

THE INFORMATION CONTAINED HEREIN IS DEEMED TO BE CONFIDENTIAL, PROPRIETARY, AND A TRADE SECRET OF TESLA MOTORS. THIS INFORMATION MAY NOT BE USED, REPRODUCED, OR DISCLOSED AS THE DIRECT OR INDIRECT BASIS FOR THE DEVELOPMENT, MANUFACTURE, OR SALE OF PROCESSES OR PRODUCTS WITHOUT THE EXPRESSED WRITTEN CONSENT OF TESLA MOTORS.

DRAWN	CHECKED	APPROVED
MATERIAL AS SPECIFIED	FINISHING AS SPECIFIED	SCALE NONE
PART NAME Seats Front Left		
PART NUMBER	REV	SHEET
	1	44 OF 54
		SIZE A0

Body Controller Right
B,P,J,W X056 X050A X050B X051 X059 X057 X053A X053B X052 X055 X058 X060



TESLA

THE INFORMATION CONTAINED HEREIN IS DEEMED TO BE CONFIDENTIAL, PROPRIETARY, AND A TRADE SECRET OF TESLA MOTORS. THIS INFORMATION MAY NOT BE USED, REPRODUCED, OR DISCLOSED AS THE DIRECT OR INDIRECT BASIS FOR THE DEVELOPMENT, MANUFACTURE, OR SALE OF PROCESSES OR PRODUCTS WITHOUT THE EXPRESSED WRITTEN CONSENT OF TESLA MOTORS.

DRAWN	CHECKED	APPROVED
MATERIAL AS SPECIFIED	FINISHING AS SPECIFIED	SCALE NONE
PART NAME Seats Front Right		
PART NUMBER	REV 1	SHEET 45 OF 54
		SIZE A0

Body Controller Right
B,P,I,W X056 X050A X050B X051 X059 X057 X053A X053B X052 X055 X058 X060

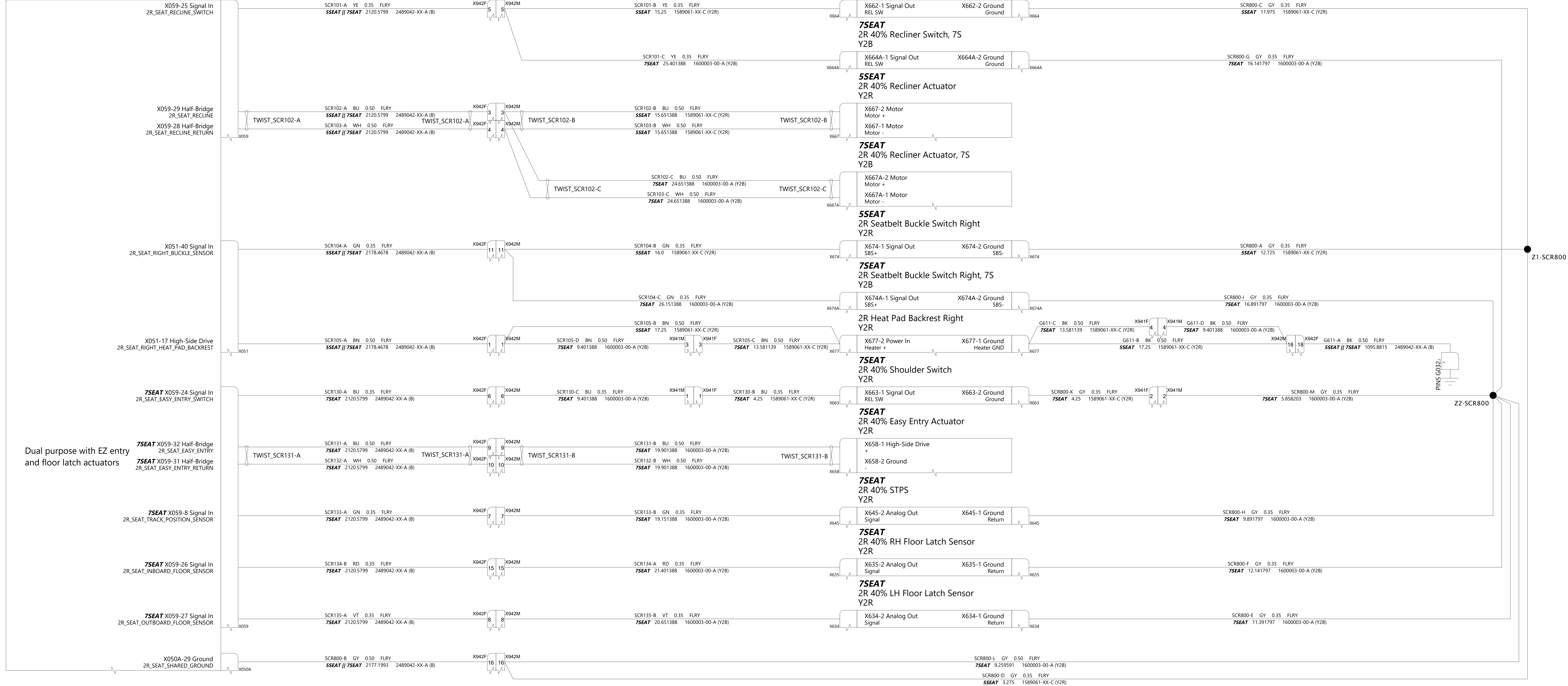

THE INFORMATION CONTAINED HEREIN IS DEEMED TO BE CONFIDENTIAL, PROPRIETARY, AND A TRADE SECRET OF TESLA MOTORS. THIS INFORMATION MAY NOT BE USED, REPRODUCED, OR DISCLOSED AS THE DIRECT OR INDIRECT BASIS FOR THE DEVELOPMENT, MANUFACTURE, OR SALE OF PROCESSES OR PRODUCTS WITHOUT THE EXPRESSED WRITTEN CONSENT OF TESLA MOTORS.

DRAWN	CHECKED	APPROVED
MATERIAL AS SPECIFIED	FINISHING AS SPECIFIED	SCALE NONE
PART NAME Seats Second Row 40%		
PART NUMBER	REV	SHEET
	1	46 of 54
		SIZE A0



THE INFORMATION CONTAINED HEREIN IS DEEMED TO BE CONFIDENTIAL, PROPRIETARY, AND A TRADE SECRET OF TESLA MOTORS. THIS INFORMATION MAY NOT BE USED, REPRODUCED, OR DISCLOSED AS THE DIRECT OR INDIRECT BASIS FOR THE DEVELOPMENT, MANUFACTURE, OR SALE OF PROCESSES OR PRODUCTS WITHOUT THE EXPRESSED WRITTEN CONSENT OF TESLA MOTORS.

DRAWN	CHECKED	APPROVED

MATERIAL AS SPECIFIED	FINISHING AS SPECIFIED	SCALE NONE

PART NAME
Seats Second Row 60%

PART NUMBER	REV	SHEET	SIZE
	1	47 OF 54	A0

Body Controller Left
A,D,J,W X036 X030A X030B X031 X039 X037 X033A X033B X032 X035 X038

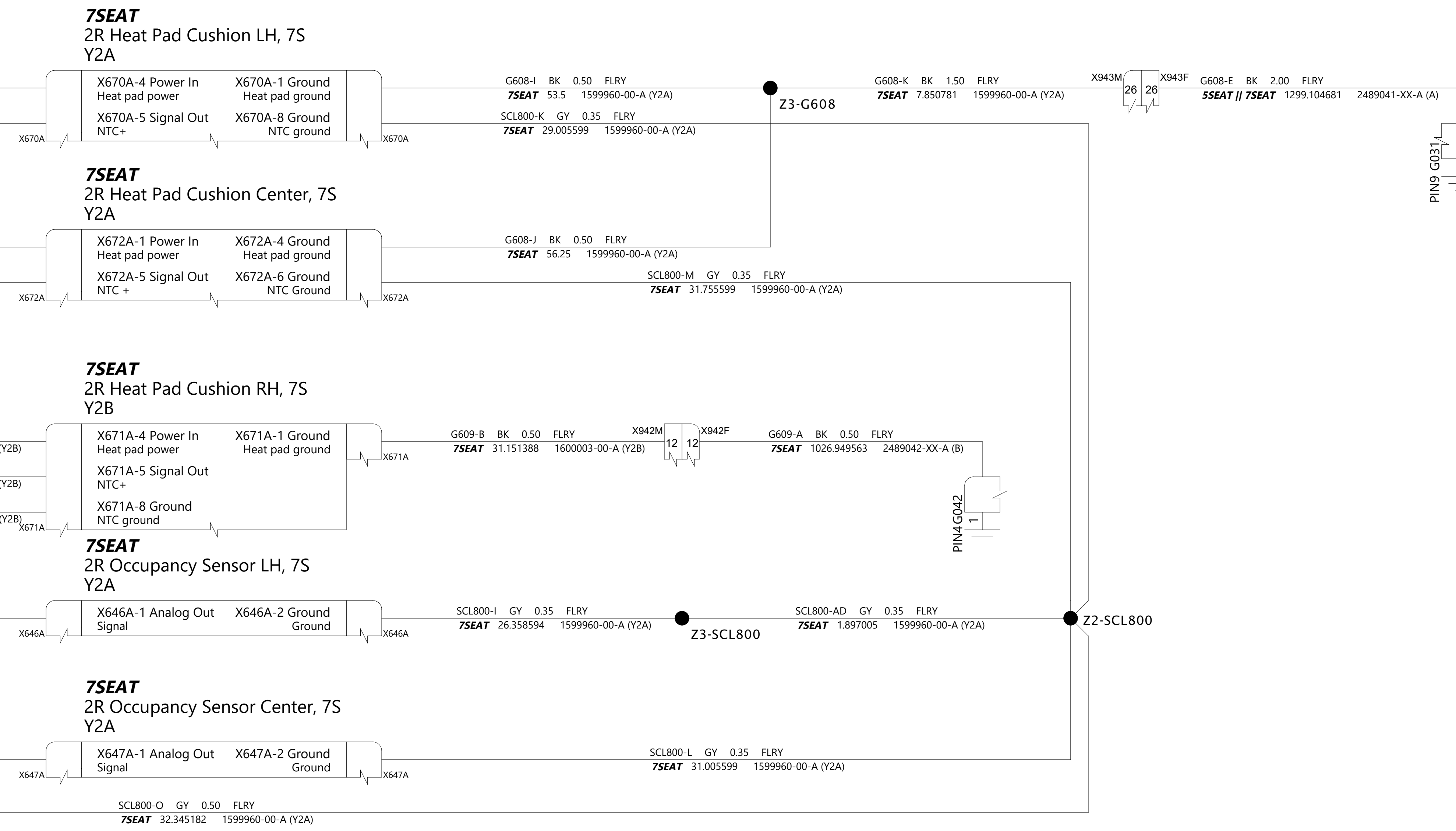
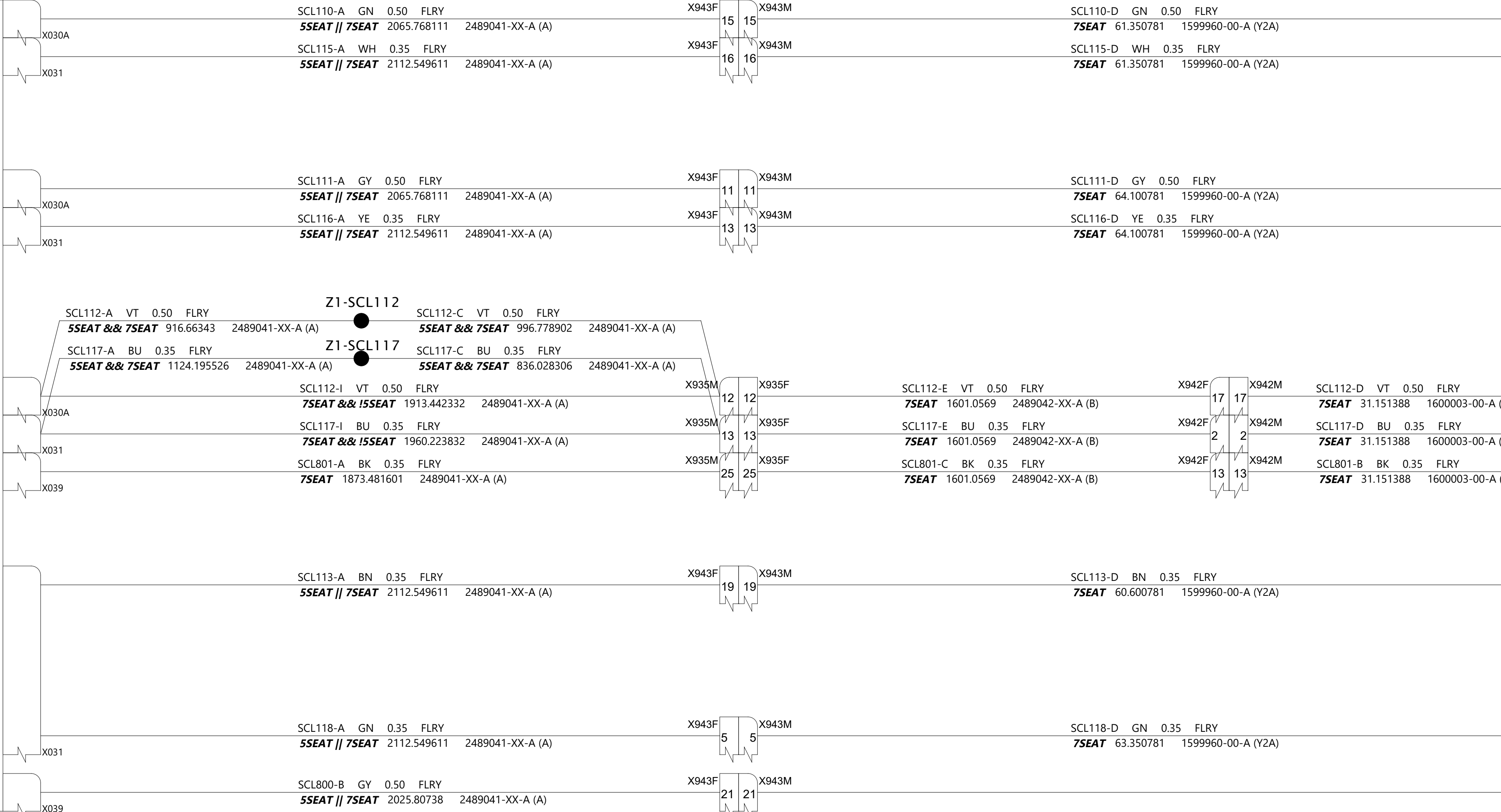
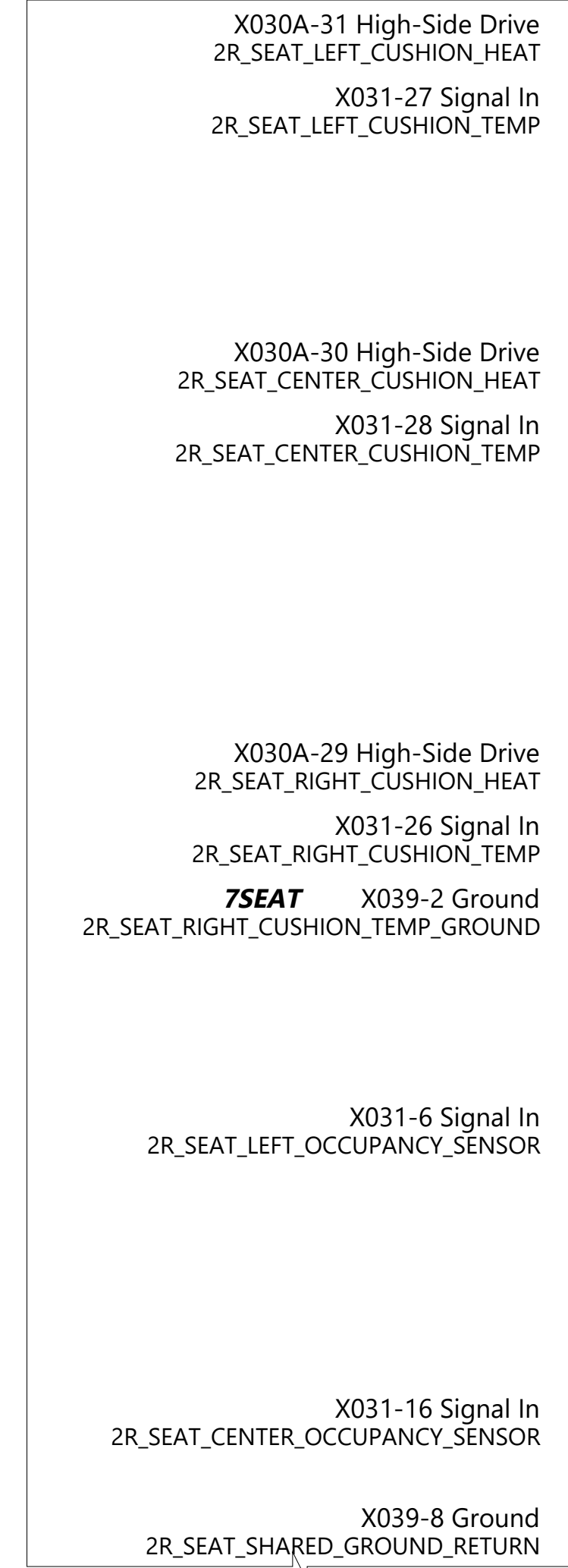

Body Controller Right
B,P,J,W X056 X050A X050B X051 X059 X057 X053A X053B X052 X055 X058 X060

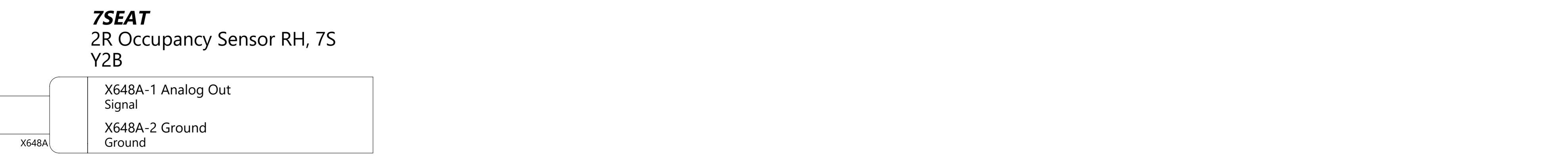
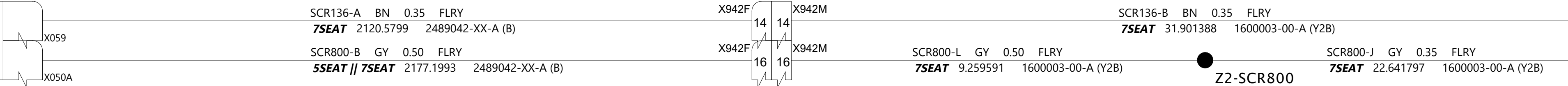
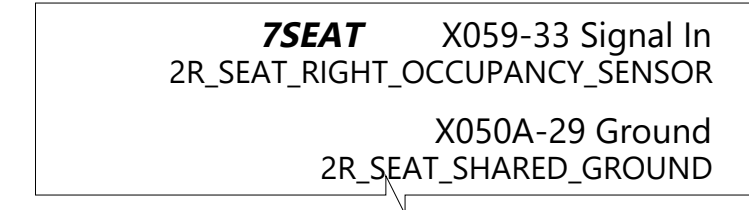

THE INFORMATION CONTAINED HEREIN IS DEEMED TO BE CONFIDENTIAL, PROPRIETARY, AND A TRADE SECRET OF TESLA MOTORS. THIS INFORMATION MAY NOT BE USED, REPRODUCED, OR DISCLOSED AS THE DIRECT OR INDIRECT BASIS FOR THE DEVELOPMENT, MANUFACTURE, OR SALE OF PROCESSES OR PRODUCTS WITHOUT THE EXPRESSED WRITTEN CONSENT OF TESLA MOTORS.

DRAWN	CHECKED	APPROVED
MATERIAL AS SPECIFIED	FINISHING AS SPECIFIED	SCALE NONE
PART NAME Seats Second Row Cushion 7-Seater		
PART NUMBER	REV 1	SHEET 49 OF 54
		SIZE A0

Body Controller Left
A,D,J,W X036 X030A X030B X031 X039 X037 X033A X033B X032 X035 X038

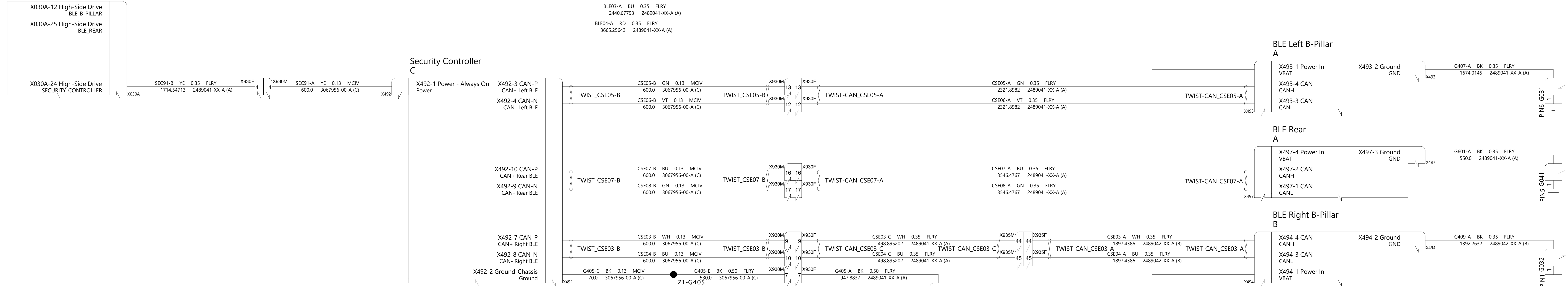

Body Controller Right
B,P,J,W X056 X050A X050B X051 X059 X057 X053A X053B X052 X055 X058 X060

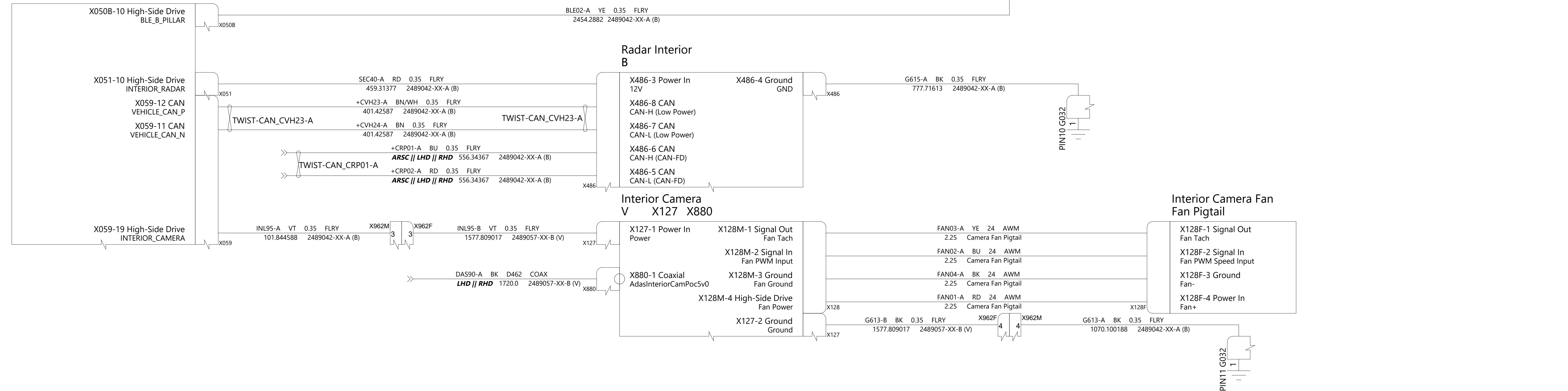

TESLA

THE INFORMATION CONTAINED HEREIN IS DEEMED TO BE CONFIDENTIAL, PROPRIETARY, AND A TRADE SECRET OF TESLA MOTORS. THIS INFORMATION MAY NOT BE USED, REPRODUCED, OR DISCLOSED AS THE DIRECT OR INDIRECT BASIS FOR THE DEVELOPMENT, MANUFACTURE, OR SALE OF PROCESSES OR PRODUCTS WITHOUT THE EXPRESSED WRITTEN CONSENT OF TESLA MOTORS.

DRAWN	CHECKED	APPROVED
-------	---------	----------

MATERIAL AS SPECIFIED	FINISHING AS SPECIFIED	SCALE NONE
--------------------------	---------------------------	---------------

PART NAME
Security Controls

PART NUMBER	REV	SHEET	SIZE
	1	51 OF 54	A0

Body Controller Front
W,U X021 X012 X011 X010 X015 X014

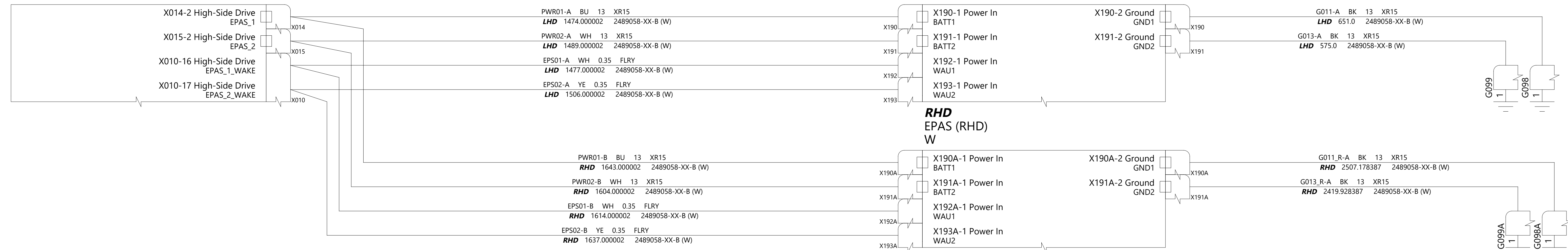

Body Controller Left
A,D,J,W X036 X030A X030B X031 X039 X037 X033A X033B X032 X035 X038

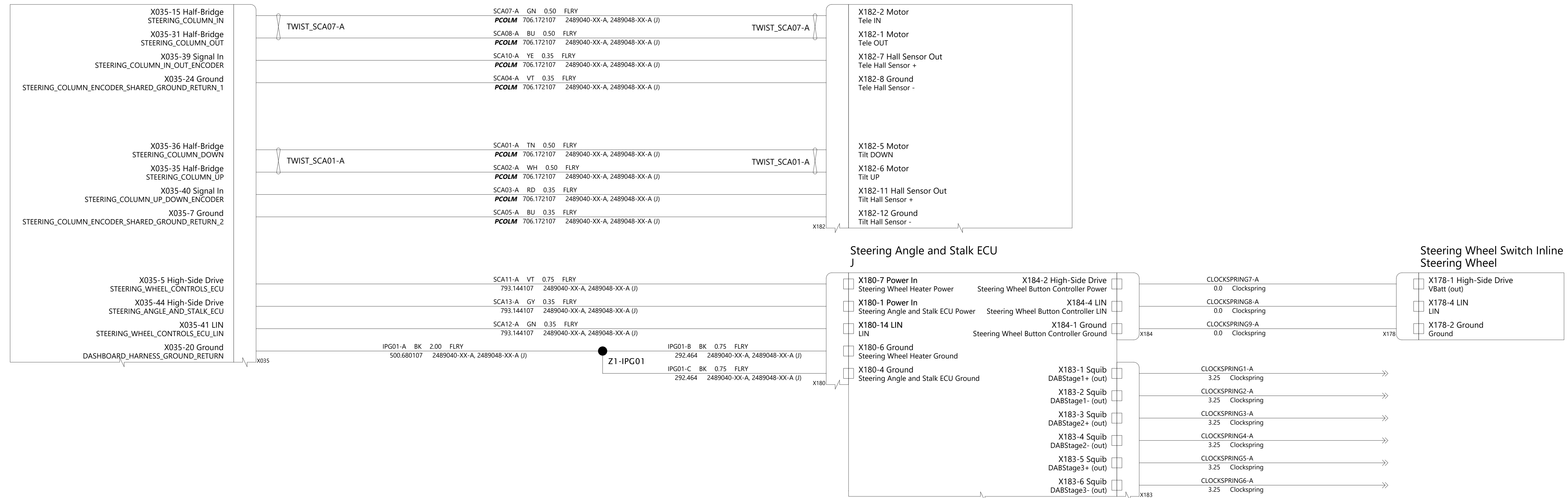

THE INFORMATION CONTAINED HEREIN IS DEEMED TO BE CONFIDENTIAL, PROPRIETARY, AND A TRADE SECRET OF TESLA MOTORS. THIS INFORMATION MAY NOT BE USED, REPRODUCED, OR DISCLOSED AS THE DIRECT OR INDIRECT BASIS FOR THE DEVELOPMENT, MANUFACTURE, OR SALE OF PROCESSES OR PRODUCTS WITHOUT THE EXPRESS WRITTEN CONSENT OF TESLA MOTORS.

DRAWN	CHECKED	APPROVED
MATERIAL AS SPECIFIED	FINISHING AS SPECIFIED	SCALE NONE
PART NAME Steering		
PART NUMBER	REV 1	SHEET 52 OF 54
		SIZE A0

Body Controller Left
A,D,J,W X036 X030A X030B X031 X039 X037 X033A X033B X032 X035 X038

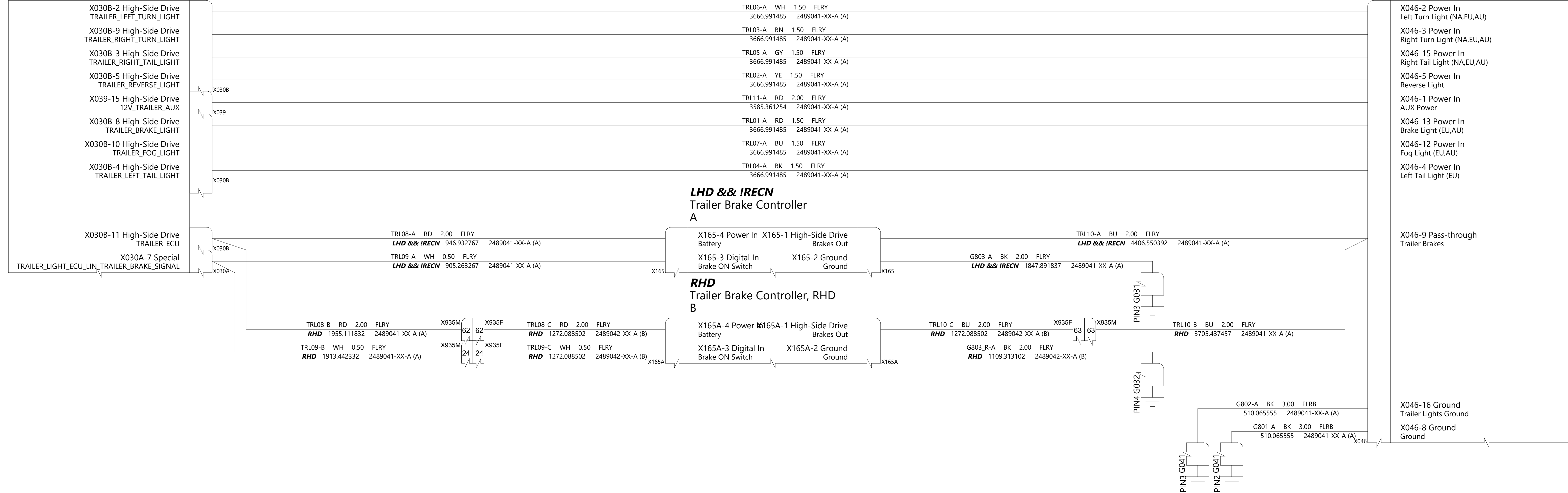

Trailer Inline
A

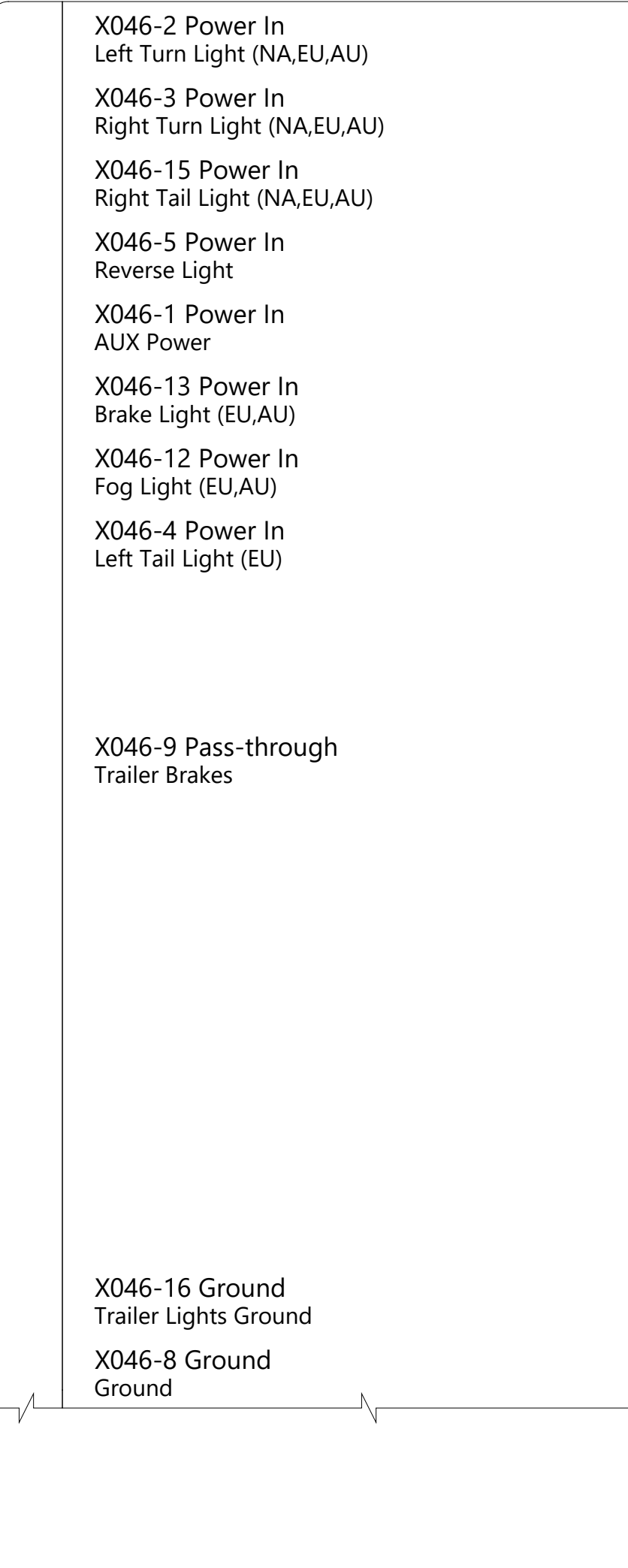

Trailer Inline to Vehicle
Z

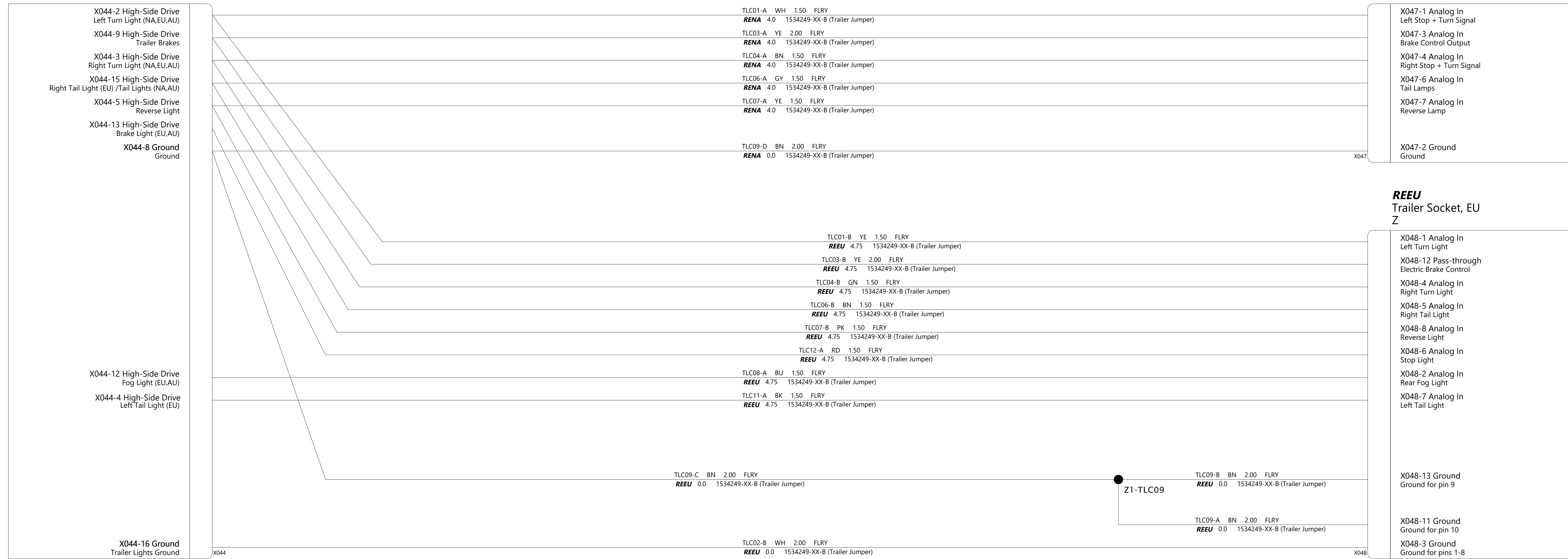

THE INFORMATION CONTAINED HEREIN IS DEEMED TO BE CONFIDENTIAL, PROPRIETARY, AND A TRADE SECRET OF TESLA MOTORS. THIS INFORMATION MAY NOT BE USED, REPRODUCED, OR DISCLOSED AS THE DIRECT OR INDIRECT BASIS FOR THE DEVELOPMENT, MANUFACTURE, OR SALE OF PROCESSES OR PRODUCTS WITHOUT THE EXPRESSED WRITTEN CONSENT OF TESLA MOTORS.

DRAWN	CHECKED	APPROVED
MATERIAL AS SPECIFIED	FINISHING AS SPECIFIED	SCALE NONE
PART NAME Towing		
PART NUMBER	REV	SHEET
	1	53 of 54
		SCALE A0

Body Controller Right
B,P,J,W X056 X050A X050B X051 X059 X057 X053A X053B X052 X055 X058 X060



Body Controller Right
B,P,J,W X056 X050A X050B X051 X059 X057 X053A X053B X052 X055 X058 X060

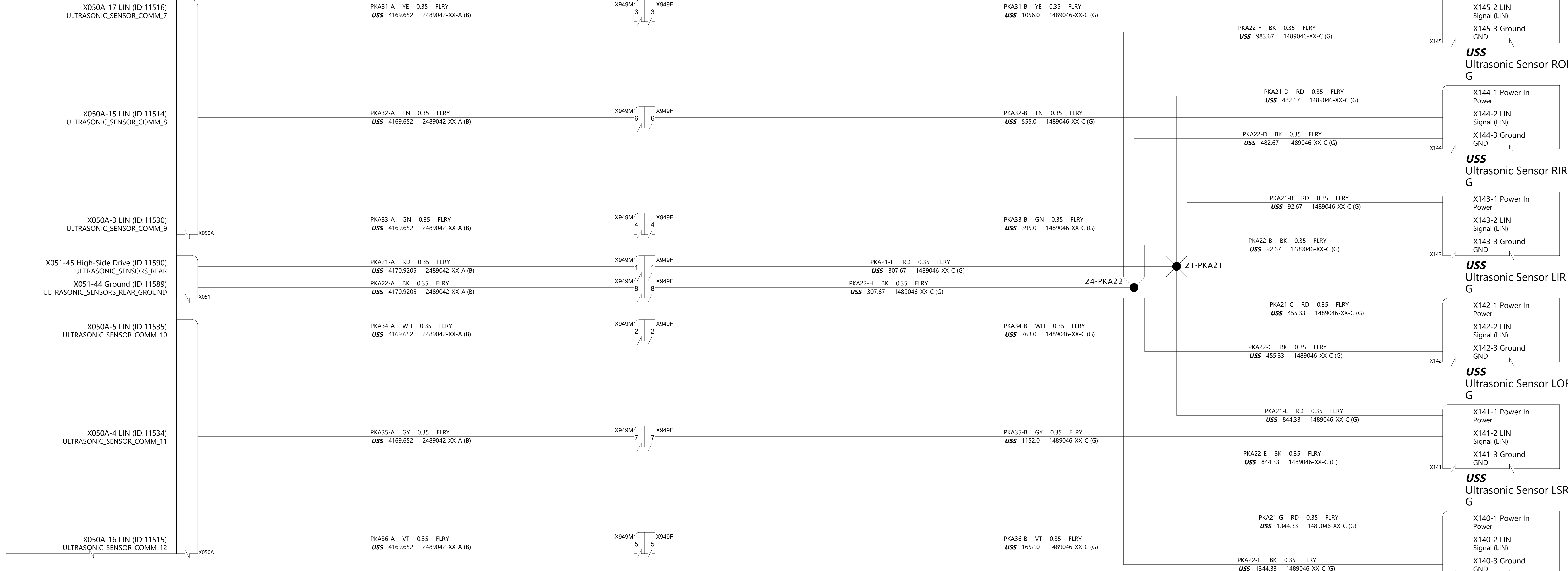

THE INFORMATION CONTAINED HEREIN IS DEEMED TO BE CONFIDENTIAL, PROPRIETARY, AND A TRADE SECRET OF TESLA MOTORS. THIS INFORMATION MAY NOT BE USED, REPRODUCED, OR DISCLOSED AS THE DIRECT OR INDIRECT BASIS FOR THE DEVELOPMENT, MANUFACTURE, OR SALE OF PROCESSES OR PRODUCTS WITHOUT THE EXPRESSED WRITTEN CONSENT OF TESLA MOTORS.

DRAWN	CHECKED	APPROVED
MATERIAL AS SPECIFIED	FINISHING AS SPECIFIED	SCALE NONE
PART NAME Ultrasonics		
PART NUMBER	REV	SHEET
	1	54 OF 54
		SIZE A0