

Page	Description
1	Table of Contents
2	Vehicle Controller Layout, Front
3	Vehicle Controller Layout, Side
4	Air Suspension
5	Audio: External Amp
6	Audio: MCU Amp & Radio
7	Audio: Microphones
8	Battery Pack
9	Body Controllers: Main Distribution & Logic
10	Brake and Stability
11	CAN Network: Chassis
12	CAN Network: Party
13	CAN Network: REM
14	CAN Network: Vehicle
15	Center Console
16	Charge Port
17	Diagnostics & Cut Loop
18	Door Front Left
19	Door Front Right
20	Door Rear 1/2: Handle, Window, Latch
21	Door Rear 2/2: Trim
22	Drive Inverters 1/2: Power & Comms
23	Drive Inverters 2/2: Resolvers & Pedals
24	Driver Assistance
25	Exterior Illumination - Front & Rear
26	Exteriors - Defrost & Wipers
27	Frunk Actuators/Sensors
28	Grounding: Front Center
29	Grounding: Front Left & Right
30	Grounding: Left A-Pillar & Rear
31	Grounding: Liftgate
32	Grounding: Right A-Pillar & Rear
33	Headliner
34	HV Penthouse & HVIL
35	HVAC: Cabin Climate 1/2
36	HVAC: Cabin Climate 2/2
37	HVAC: Case
38	HVAC: Powertrain & Battery
39	HVAC: Thermal Bar
40	Instrumental Panel
41	Liftgate Actuators/Sensors
42	Power Distribution, Battery Controller
43	Power Distribution, Front Controller
44	Power Distribution, Left Controller 1/3
45	Power Distribution, Left Controller 2/3
46	Power Distribution, Left Controller 3/3
47	Power Distribution, Right Controller 1/3
48	Power Distribution, Right Controller 2/3
49	Power Distribution, Right Controller 3/3
50	Restraints Controler Module 1/4
51	Restraints Controler Module 2/4
52	Restraints Controler Module 3/4
53	Restraints Controler Module 4/4
54	RF/Special Cables 1/2
55	RF/Special Cables 2/2
56	Seats Front 1/2
57	Seats Front 2/2
58	Seats - 2nd Row
59	Security
60	Ultrasonics

Table 1: Abbreviations

LF	Left Front	RF	Right Front
LR	Left Rear	RR	Right Rear
LHS	Left-Hand Side	RHS	Right-Hand Side

Table 2: Harness Designators

A	LH BODY	OJ	HV PENTHOUSE JUMPER
B	RH BODY	OP	HV PYRO
C	CENTER CONSOLE	P	RH FR DOOR
D	LH FR DOOR	R	LH RR DOOR
DT	FR DOOR TRIM	RT	RR DOOR TRIM
F	FR FASCIA	S	RH RR DOOR
G	RR FASCIA	T	LIFT GATE
J	IP	UHP	THERMAL
JT	IP TRIM	W	FRUNK
K	HEADLINER	X	REAR SUBFRAME
L	FRONT END MODULE	XT	REAR SUBFRAME, PERFORMANCE
LA	LIFT GATE, AUDIO	Y	FRONT SEATS
LT	LIFT GATE, TUNER	YYL	SECOND ROW SEAT, LEFT BACKREST
N	FRONT SUBFRAME	YYR	SECOND ROW SEAT, RIGHT BACKREST
OM	HV PACK	YYRJ	SECOND ROW SEAT, RIGHT SHOULDER
		Z	MISC. CABLES

Table 3: Wire Color Designators

BK	Black	OG	Orange
BN	Brown	RD	Red
BU	Blue	VT	Violet (Purple)
GN	Green	WH	White
GY	Gray	YE	Yellow

Table 4: Wire Type Designators

FLRY	Thin wall 105C rated, regular stranded PVC insulated [FLRY-A]
FLRB	Thin wall 105C rated, bunched conductor PVC insulated [FLRY-B]
MCIIV	Thin wall 105C rated, compressed conductor PVC (halogen free) insulated
XR15	Thin wall 150C rated, cross-linked polyolefin, high flexible
FLXB	Thin wall 125C rated, cross-linked polyolefin, high flexible, halogen free insulated
3TBL	Thick wall 105C rated, aluminum conductor PVC insulated
F91X	Thin wall 150C rated, cross-linked polyethylene, high flexible

Table 5: Option Codes

DRIVR	Driver Seat	PPRO	Pedestrian Protection
PASSN	Passenger Seat	SBR	Seat Belt Reminder Switch
LHST	Left side Seat	OCS	Occupant Classification System
RHST	Right Side Seat	STPS	Seat Track Position Sensor
DRLH	Left Hand Drive	TW01	Tow Package
DRRH	Right Hand Drive	X024	Performance
REEU	Region Europe	X025	Long Range
RENA	Region North America		

General Notes:

- Switches [Relays] are shown in their inactive [de-energized] state.
- Splices may be split across pages for visual clarity with respect to the function displayed on the particular page.
- Some connectors are split across multiple pages for clarity. There is no overall reference in this document for the signals routed to a specific connector.
- Wire sizes are specified in mm<sup>2</sup> cross-sectional area (CSA) per SAE 1127/8
- Wire Specification: 60V, thin-wall PVC (ISO type or equivalent). Default wire type to be rated 60VDC/25VAC and -40C to 105C operating temperature. See DIN 13602 or ISO 6722 for detailed specifications.
- Unless otherwise specified at the device pins, terminal plating is to be Tin or Pre-Tin

TERMINAL PLATING

- GOLD TERMINAL NECESSARY
- SILVER PLATING NECESSARY

- Inline connector gender specification is based on the terminal type. Inline connectors with "M" suffix have male, tab or pin terminals. Inline connectors with "F" suffix have female, receptacle or socket terminals

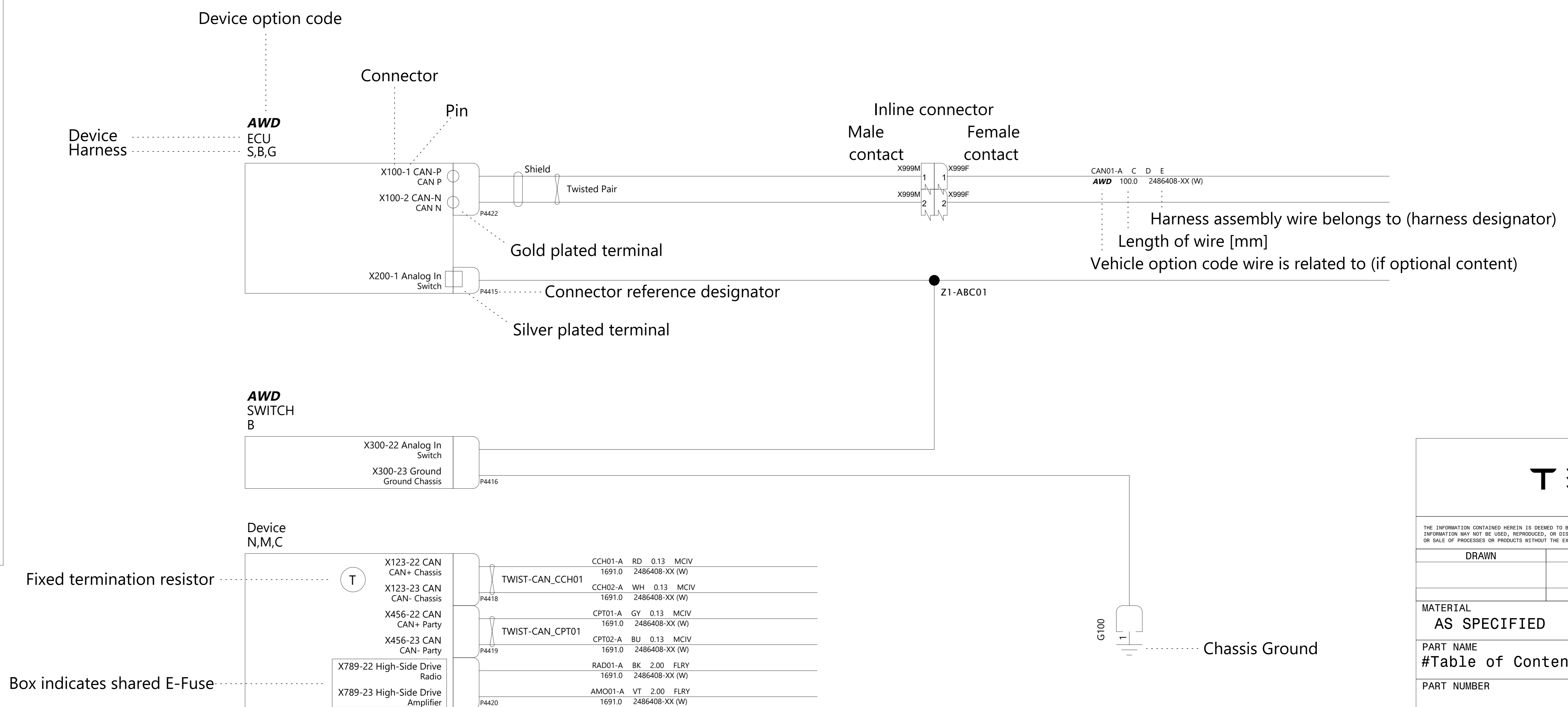

TESLA			
THE INFORMATION CONTAINED HEREIN IS DEEMED TO BE CONFIDENTIAL, PROPRIETARY, AND A TRADE SECRET OF TESLA MOTORS. THIS INFORMATION MAY NOT BE USED, REPRODUCED, OR DISCLOSED AS THE DIRECT OR INDIRECT BASIS FOR THE DEVELOPMENT, MANUFACTURE, OR SALE OF PROCESSES OR PRODUCTS WITHOUT THE EXPRESSED WRITTEN CONSENT OF TESLA MOTORS.			
DRAWN	CHECKED	APPROVED	
MATERIAL AS SPECIFIED	FINISHING AS SPECIFIED	SCALE NONE	
PART NAME #Table of Contents			
PART NUMBER	REV	SHEET	SIZE
	2	1 OF 60	A0

# VCFRONT

X010  
MAIN 1

X011  
MAIN 2

X015  
BRIDGE

X021  
THERMAL

X013  
HIGH POWER 2

X012  
HIGH POWER 1

X014  
DCDC

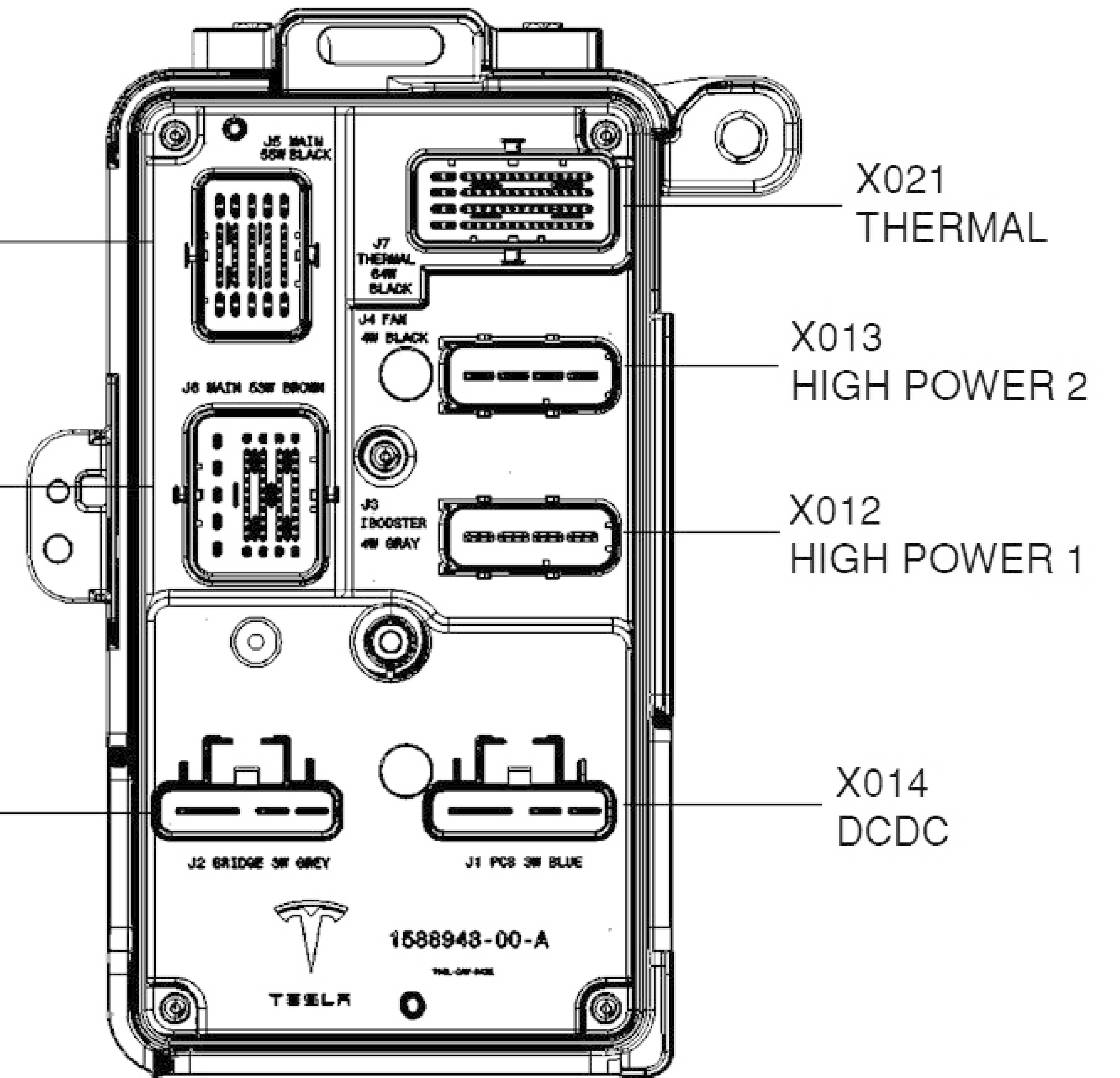

# VCBATT

X023  
HIGH POWER 2

X024  
BRIDGE

X026  
BATT

X022  
HIGH POWER 1

X025  
MAIN 1

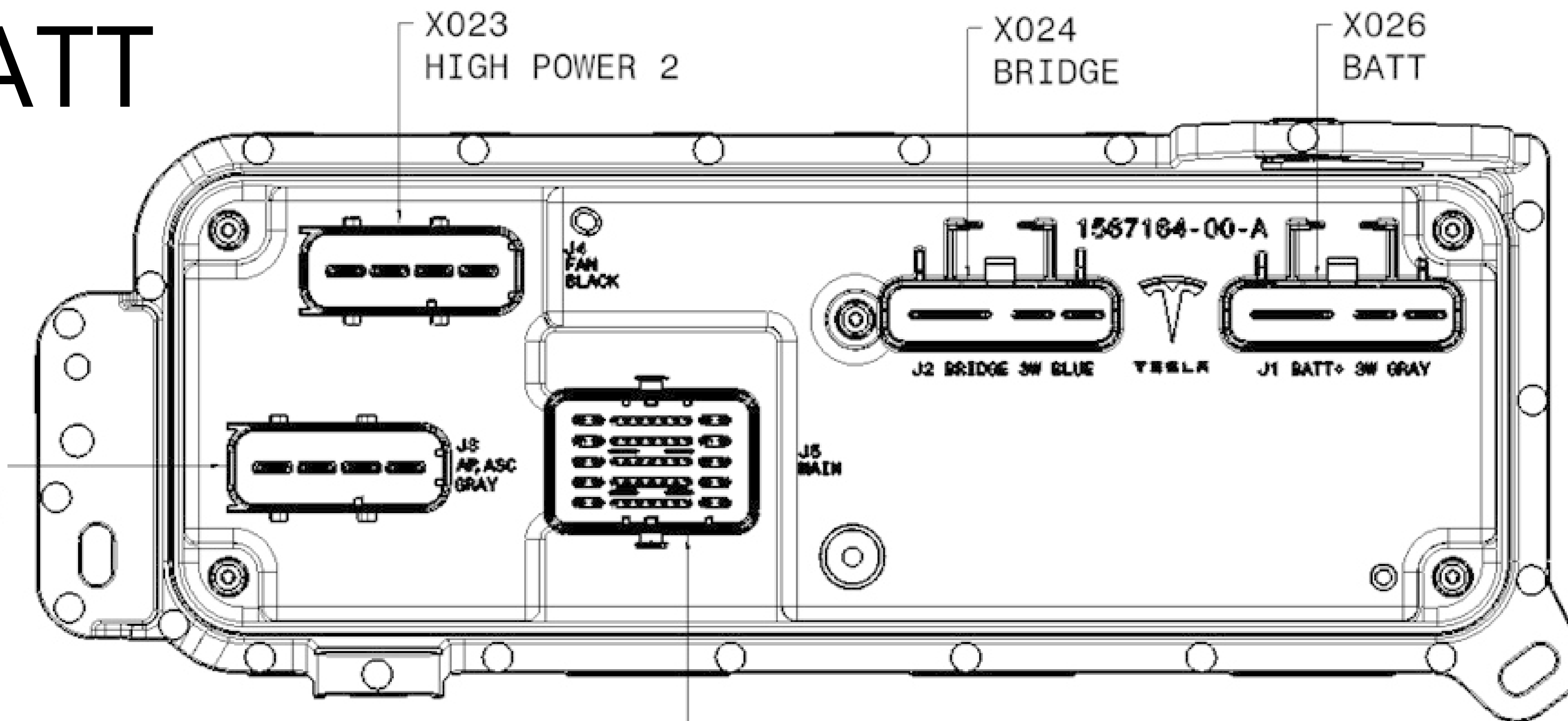

**TESLA**

THE INFORMATION CONTAINED HEREIN IS DEEMED TO BE CONFIDENTIAL, PROPRIETARY, AND A TRADE SECRET OF TESLA MOTORS. THIS INFORMATION MAY NOT BE USED, REPRODUCED, OR DISCLOSED AS THE DIRECT OR INDIRECT BASIS FOR THE DEVELOPMENT, MANUFACTURE, OR SALE OF PRODUCTS OR SERVICES WITHOUT THE EXPRESS WRITTEN CONSENT OF TESLA MOTORS.

DRAWN	CHECKED	APPROVED
-------	---------	----------

MATERIAL AS SPECIFIED	FINISHING AS SPECIFIED	SCALE NONE
--------------------------	---------------------------	---------------

PART NAME  
#Vehicle Controller Layout, Front

PART NUMBER	REV	SHEET	SIZE
	1	2 OF 61	A0

# VCLEFT

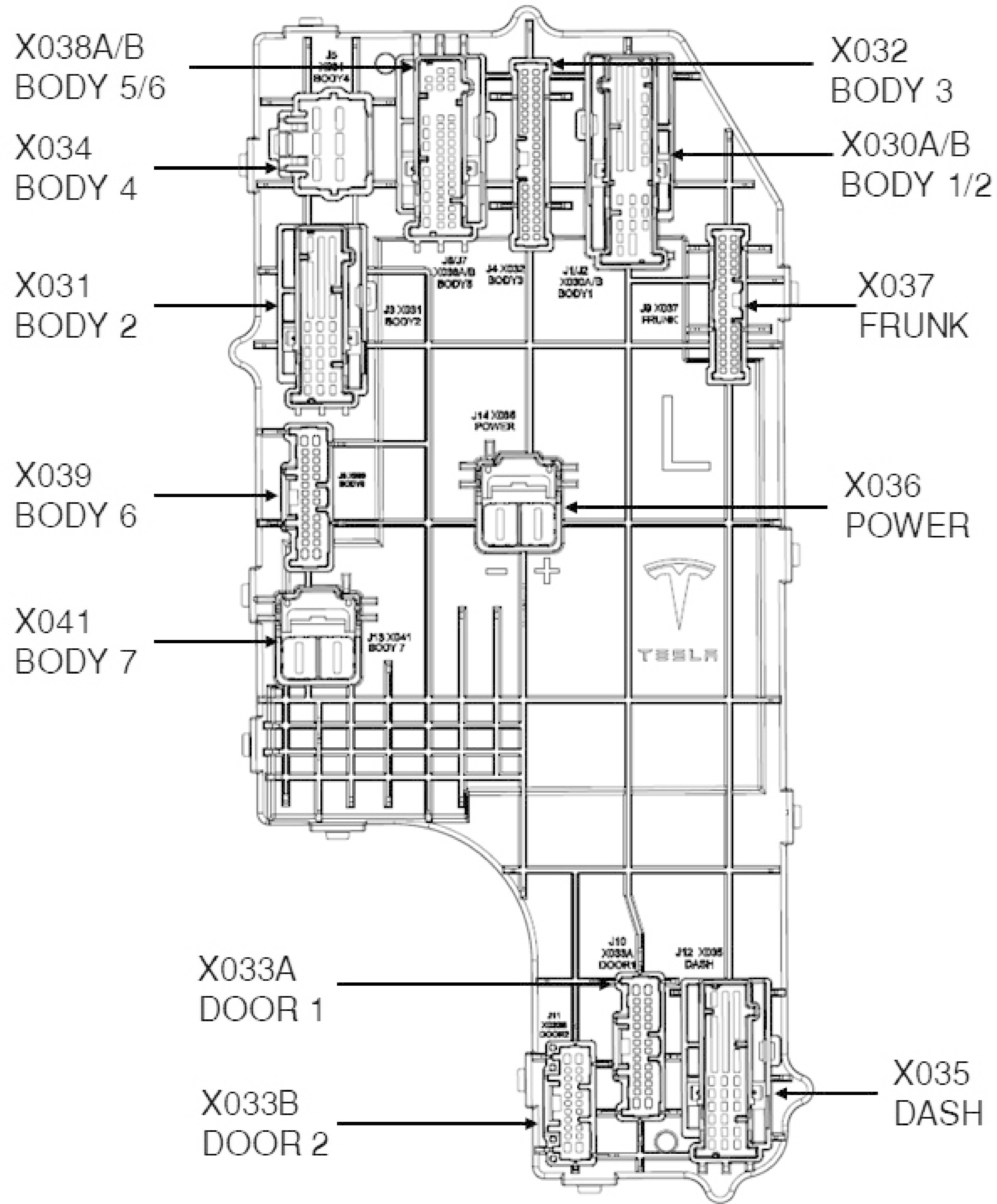

# VCRIGHT

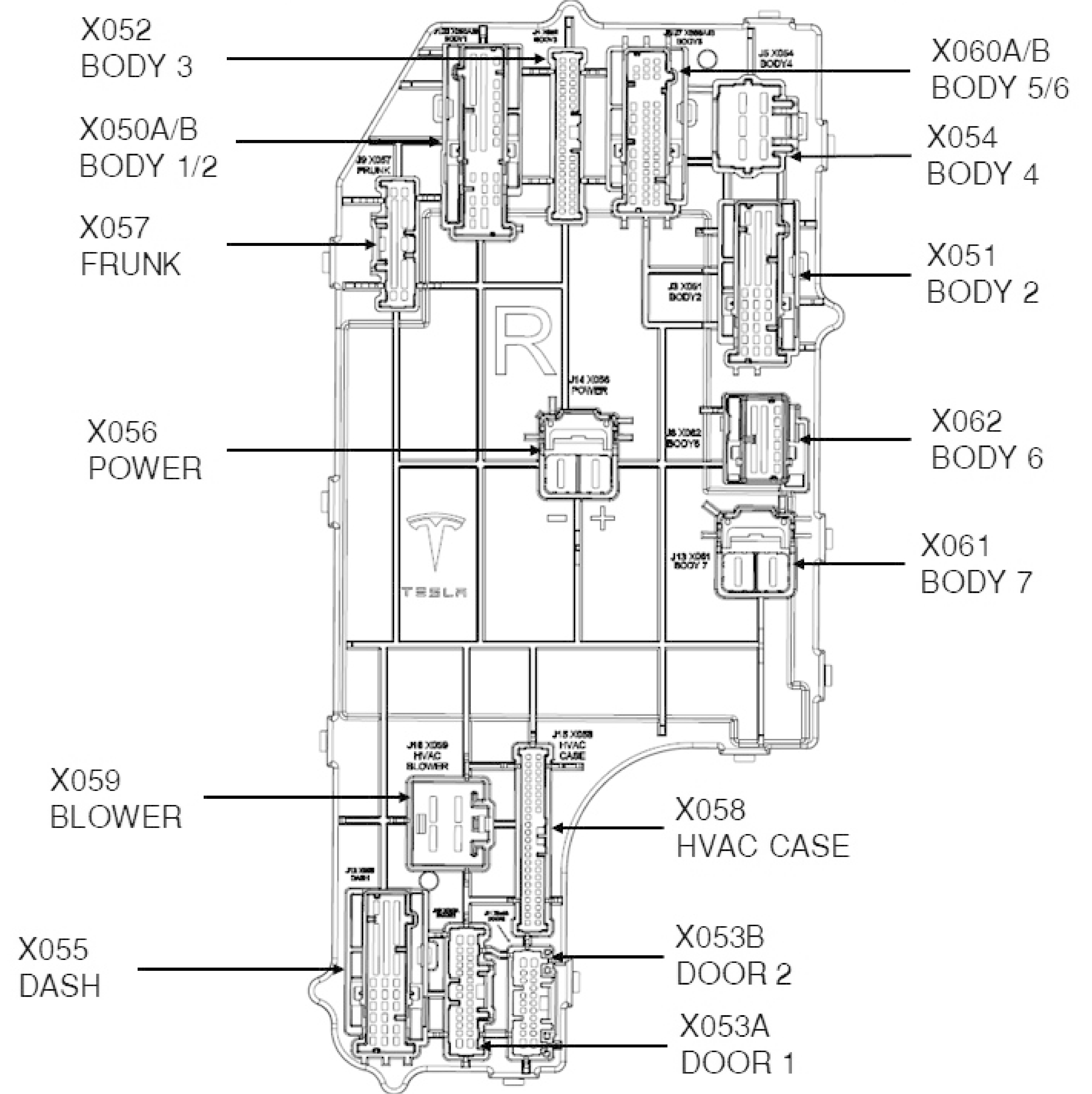

**TESLA**

THE INFORMATION CONTAINED HEREIN IS DEEMED TO BE CONFIDENTIAL, PROPRIETARY, AND A TRADE SECRET OF TESLA MOTORS. THIS INFORMATION MAY NOT BE USED, REPRODUCED, OR DISCLOSED AS THE DIRECT OR INDIRECT BASIS FOR THE DEVELOPMENT, MANUFACTURE, OR SALE OF PROCESSES OR PRODUCTS WITHOUT THE EXPRESS WRITTEN CONSENT OF TESLA MOTORS.

DRAWN	CHECKED	APPROVED
-------	---------	----------

MATERIAL AS SPECIFIED	FINISHING AS SPECIFIED	SCALE NONE
--------------------------	---------------------------	---------------

PART NAME  
#Vehicle Controller Layout, Side

PART NUMBER	REV	SHEET	SIZE
	1	3 OF 64	A0

**Body Controller Front**  
U, W X021 X010 X011 X012 X013 X014

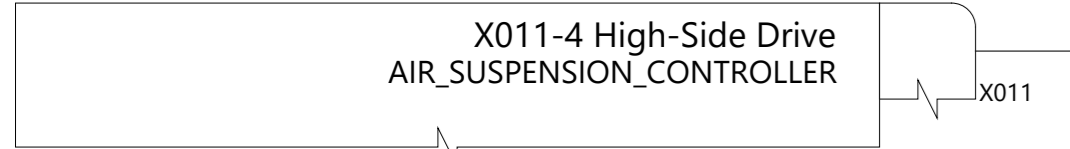

**Body Controller Battery**  
W X025 X022 X023 X024 X026

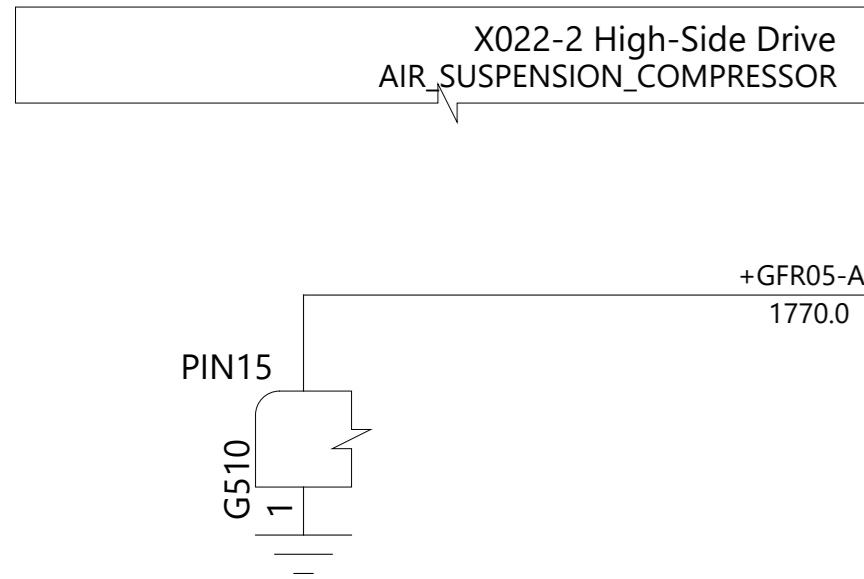

**Air Suspension Compressor**  
W X190A X191

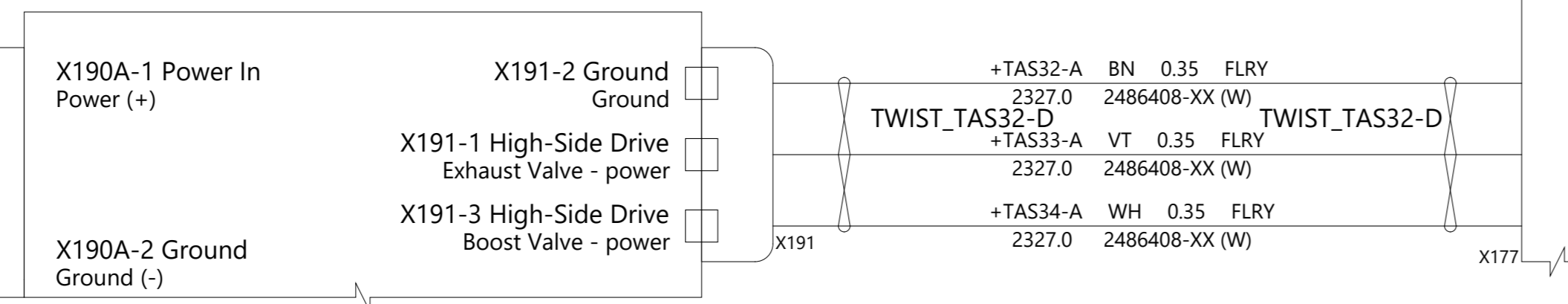

**Air Suspension Controller**  
W X176 X177 X178 X179

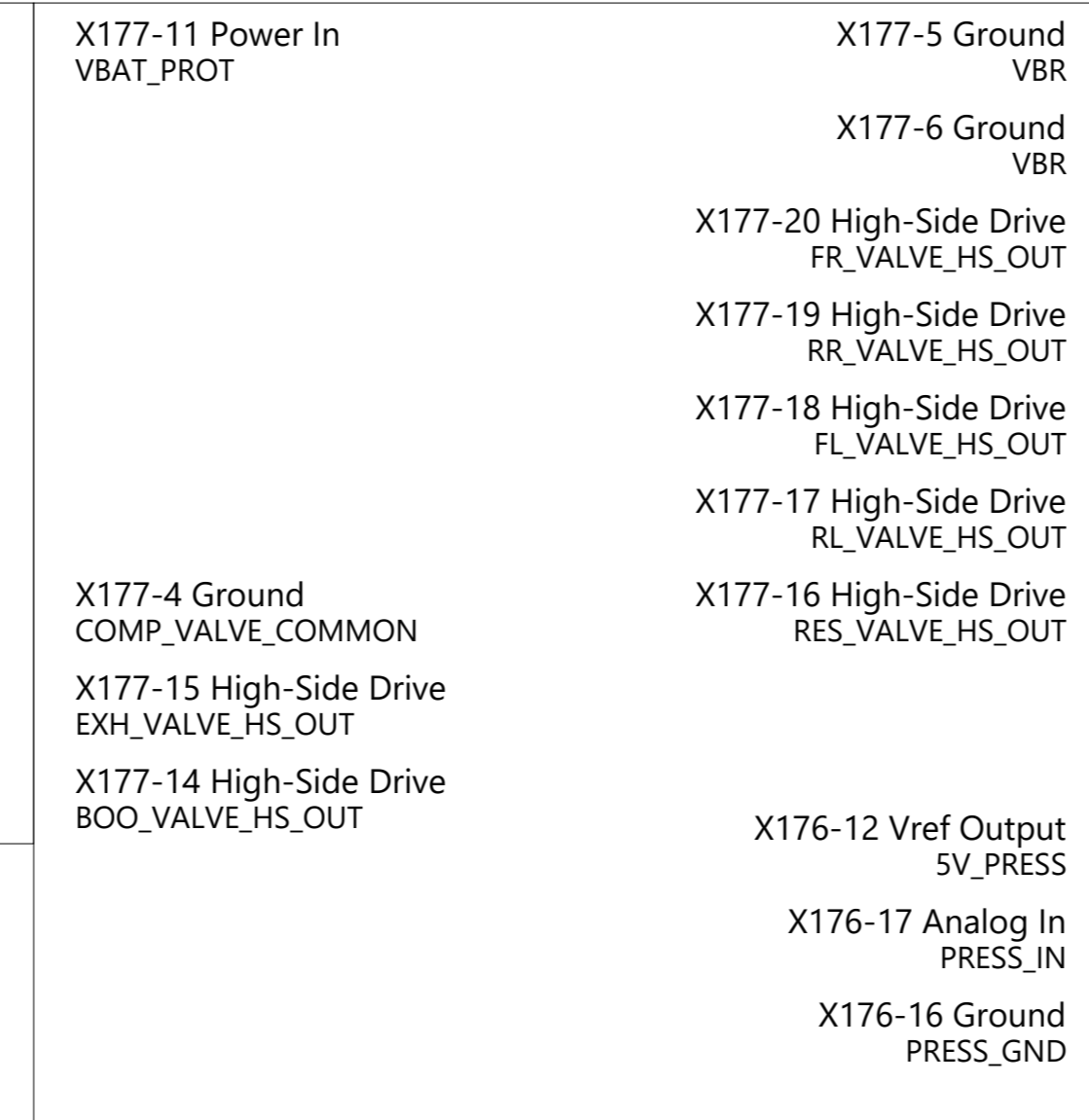

**Air Suspension Valve Block**  
W X189

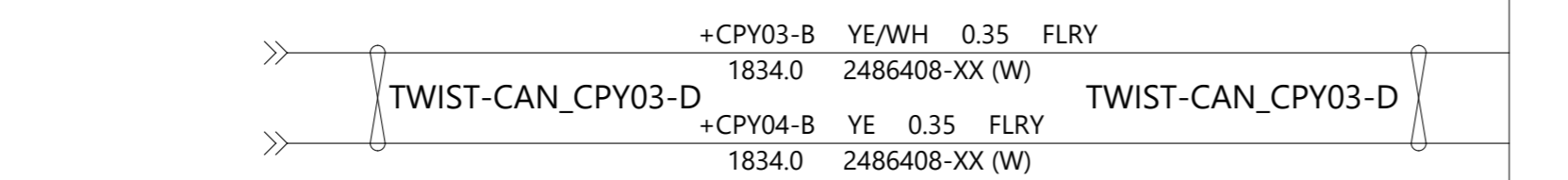
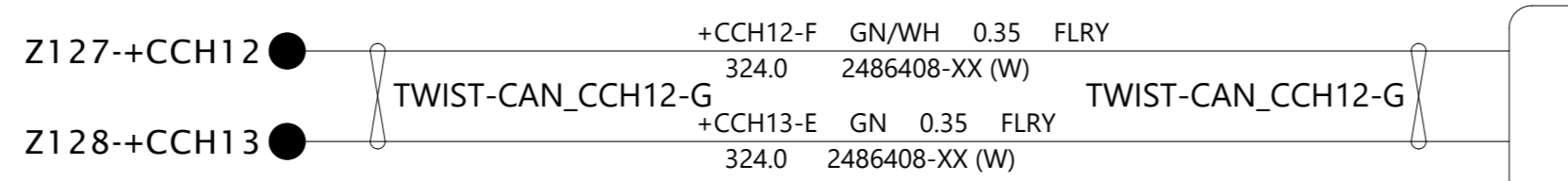
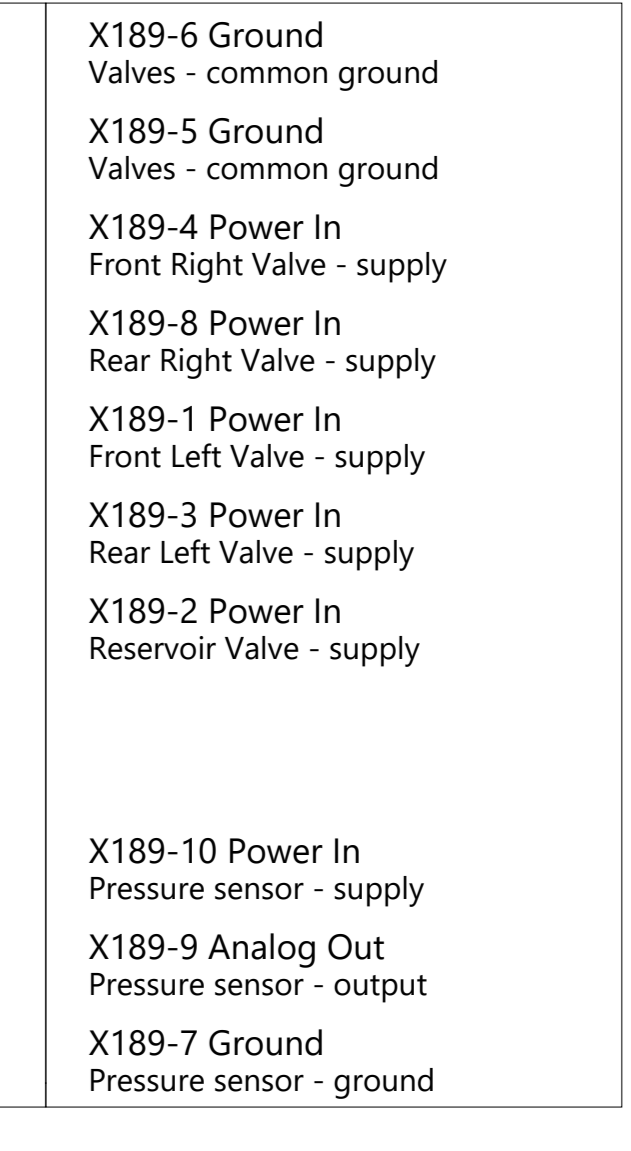

**Ride Height Sensor FL**  
W X083

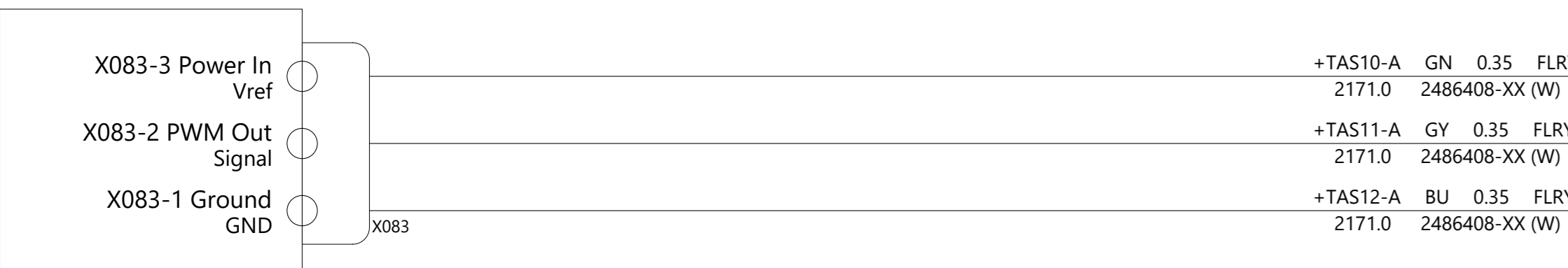

**Ride Height Sensor FR**  
W X084

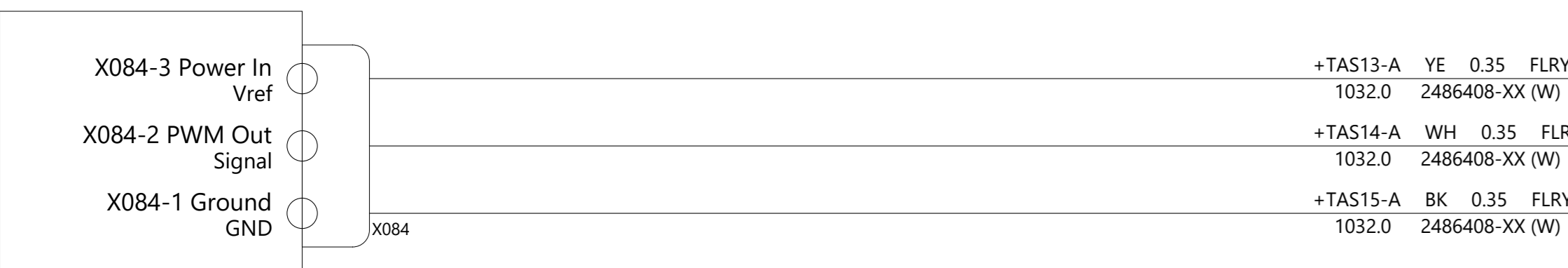

**X024 || X025**  
**Ride Height Sensor RL**  
X,XT X085

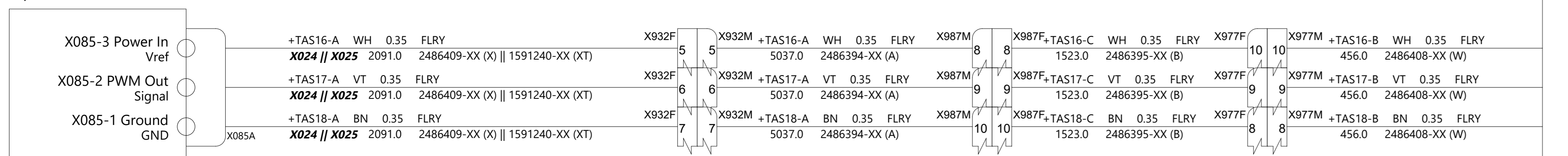

**X024 || X025**  
**Ride Height Sensor RR**  
X,XT X086

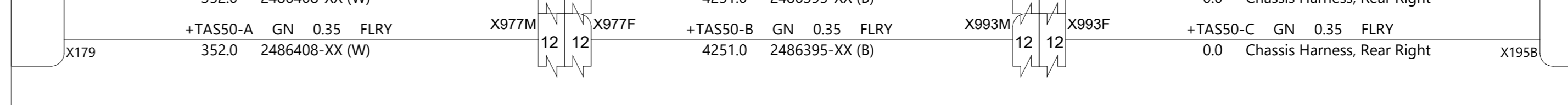
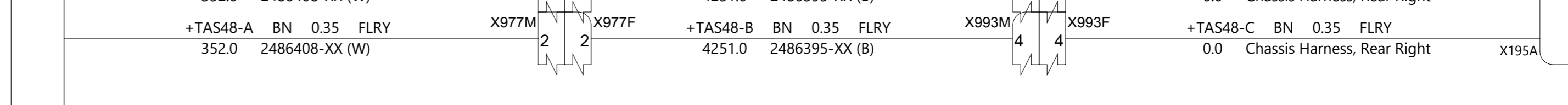
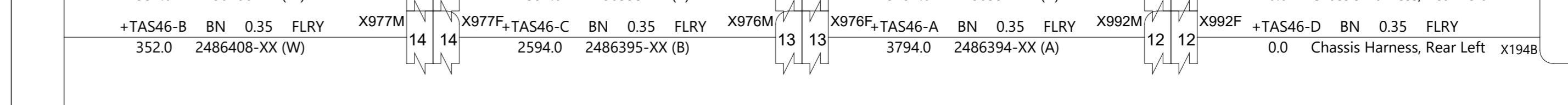
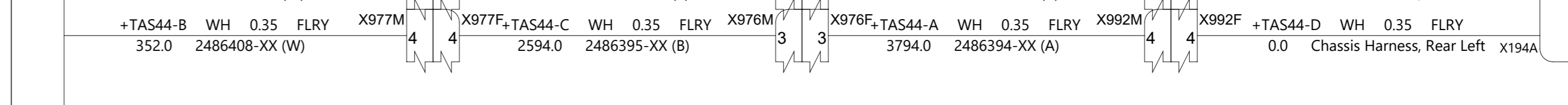
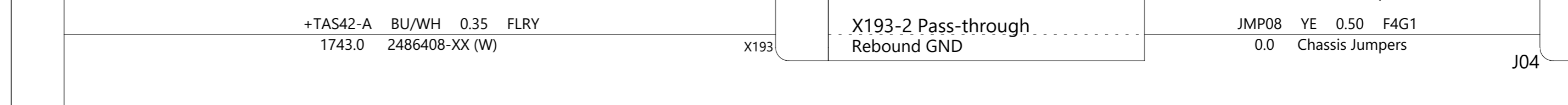
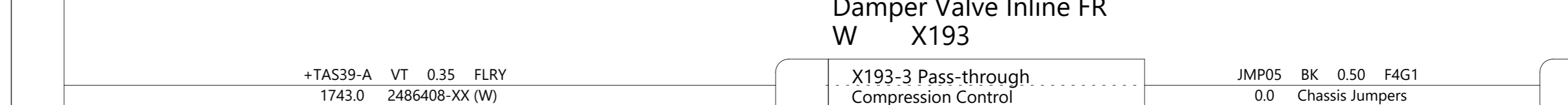
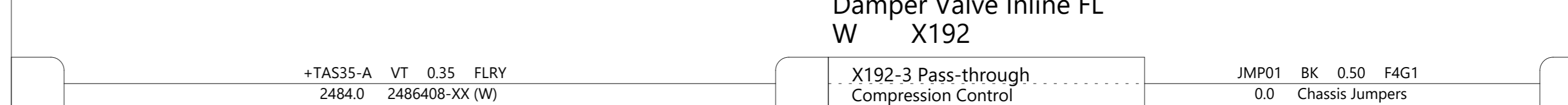
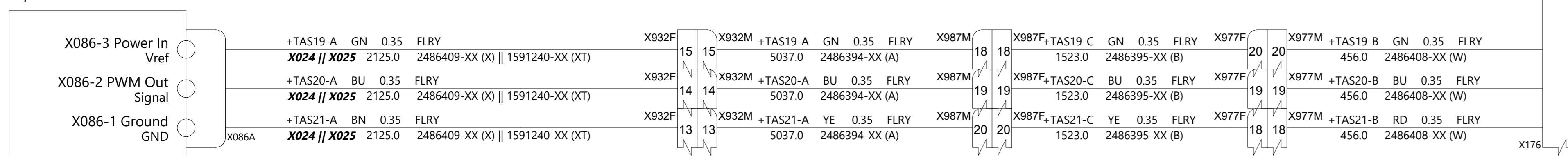

**Damper Valve Inlet FL**  
W X192

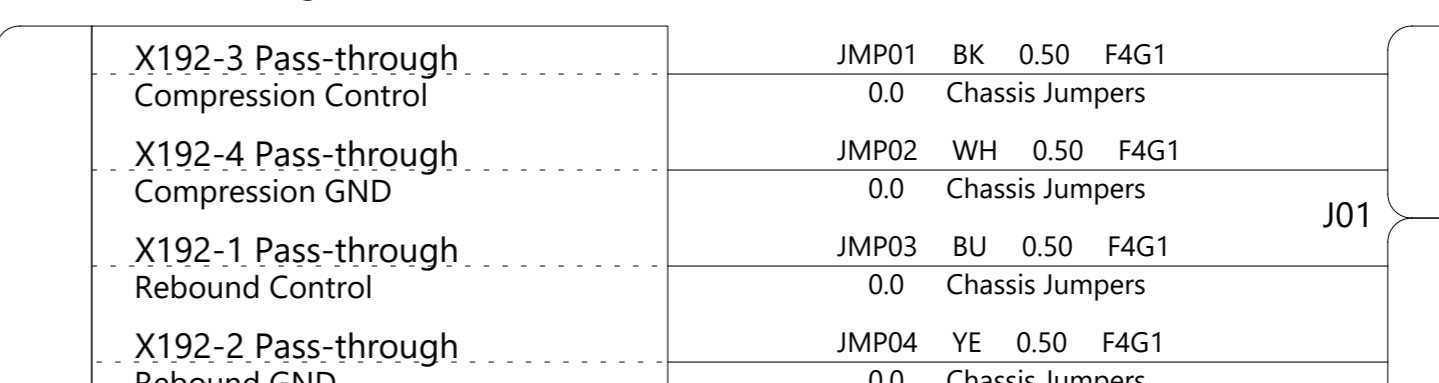

**Damper Valve Inlet FR**  
W X193

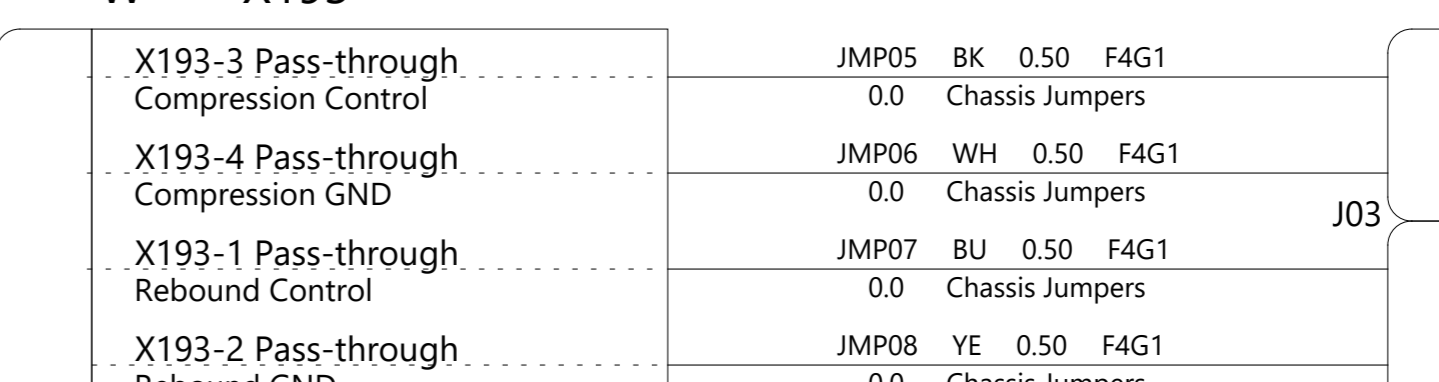

**Damper Valves FL**  
Chassis Jumpers FL J01 J02

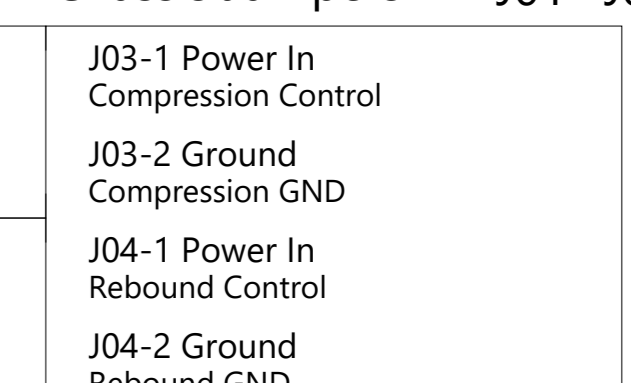

**Damper Valves FR**  
Chassis Jumpers FR J03 J04

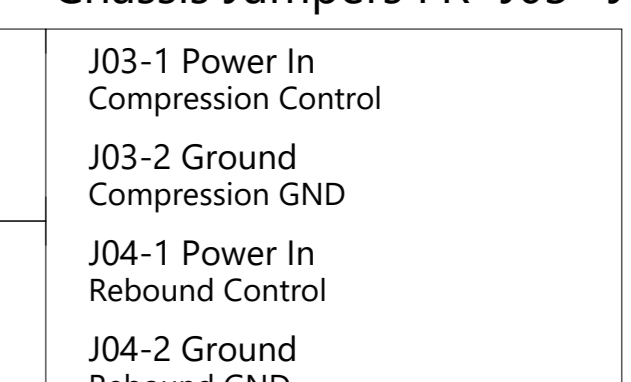

**Damper Valve Comp RL**  
XL X194A

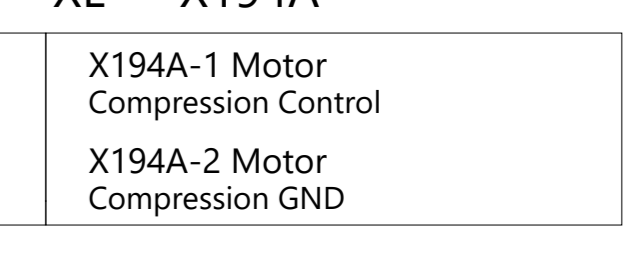

**Damper Valve Reb RL**  
XL X194B

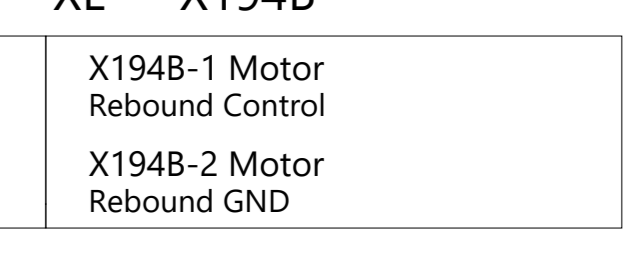

**Damper Valve Comp RR**  
XR X195A

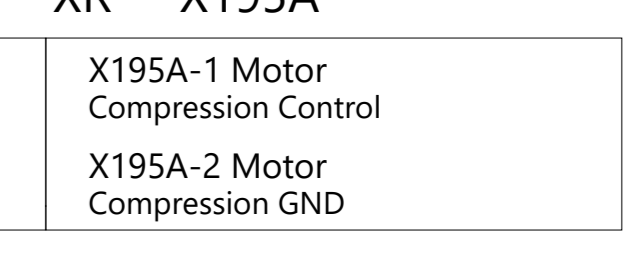

**Damper Valve Reb RR**  
XR X195B

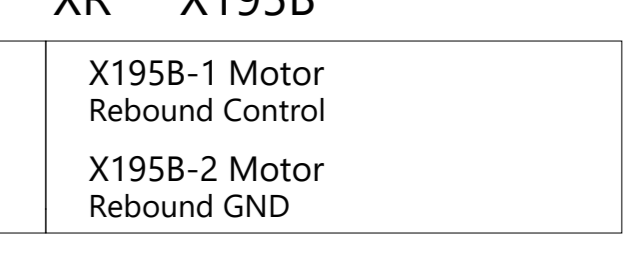

DRAWN				CHECKED		APPROVED	
MATERIAL AS SPECIFIED		FINISHING AS SPECIFIED		SCALE NONE			
PART NAME Air Suspension							
PART NUMBER		REV		SHEET		SIZE	
		1		4 of 61		A0	

External Amplifier  
B X446 X447 X448

Body Controller Right  
B,W,J,D X051 X052 X054 X060A/B X062 X053A/B X055 X056 X058 X059

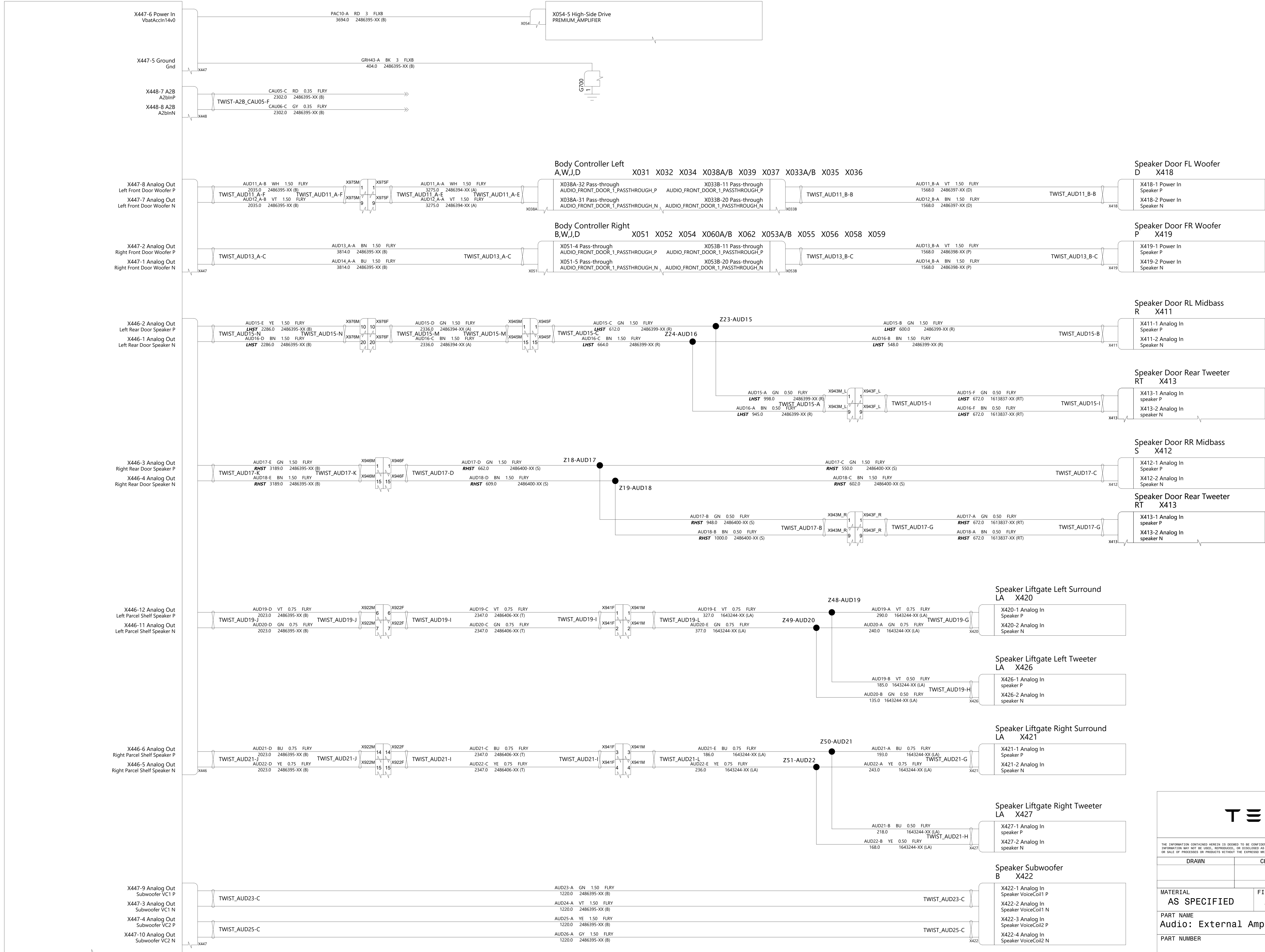

THE INFORMATION CONTAINED HEREIN IS DEEMED TO BE CONFIDENTIAL, PROPRIETARY, AND A TRADE SECRET OF TESLA MOTORS. THIS INFORMATION MAY NOT BE USED, REPRODUCED, OR DISCLOSED AS THE BASIS FOR INDEPENDENT BASIS FOR THE DEVELOPMENT, MANUFACTURE, OR SALE OF PROCESSES OR PRODUCTS WITHOUT THE EXPRESS WRITTEN CONSENT OF TESLA MOTORS.

DRAWN	CHECKED	APPROVED
MATERIAL AS SPECIFIED	FINISHING AS SPECIFIED	SCALE NONE
PART NAME Audio: External Amp		
PART NUMBER	REV	SHEET
	1	5 OF 61
		SIZE A0



THE INFORMATION CONTAINED HEREIN IS DEEMED TO BE CONFIDENTIAL, PROPRIETARY, AND A TRADE SECRET OF TESLA MOTORS. THIS INFORMATION MAY NOT BE USED, REPRODUCED, OR DISCLOSED AS THE DIRECT OR INDIRECT BASIS FOR THE DEVELOPMENT, MANUFACTURE, OR SALE OF PROCESSES OR PRODUCTS WITHOUT THE EXPRESSED WRITTEN CONSENT OF TESLA MOTORS.

DRAWN	CHECKED	APPROVED
-------	---------	----------

MATERIAL AS SPECIFIED	FINISHING AS SPECIFIED	SCALE NONE
--------------------------	---------------------------	---------------

PART NAME  
Audio: MCU Amp & Radio

PART NUMBER	REV	SHEET	SIZE
	1	6 OF 61	A0

MCU & Gateway  
W,B,J,A X452 X453 X454 X800 X803 X804 X802 X829 X860 X862 X455

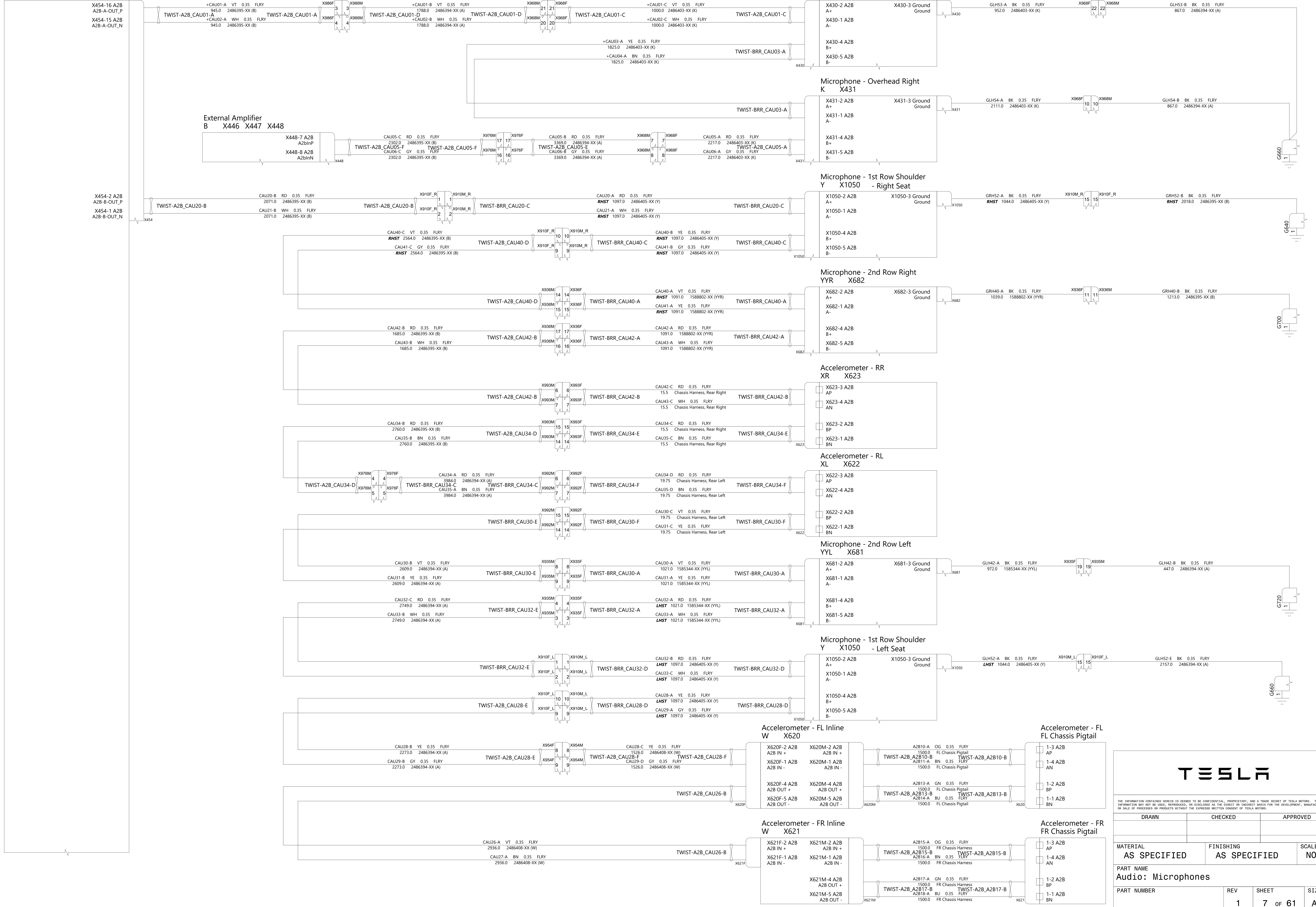

THE INFORMATION CONTAINED HEREIN IS DEEMED TO BE CONFIDENTIAL, PROPRIETARY, AND A TRADE SECRET OF TESLA MOTORS. THIS INFORMATION MAY NOT BE USED, REPRODUCED, OR DISCLOSED AS THE DIRECT OR INDIRECT BASIS FOR THE DEVELOPMENT, MANUFACTURE, OR SALE OF PROCESSES OR PRODUCTS WITHOUT THE EXPRESS WRITTEN CONSENT OF TESLA MOTORS.

DRAWN		CHECKED		APPROVED	
MATERIAL AS SPECIFIED		FINISHING AS SPECIFIED		SCALE NONE	
PART NAME Audio: Microphones					
PART NUMBER	REV	SHEET	SIZE		
	1	7 OF 61	A0		

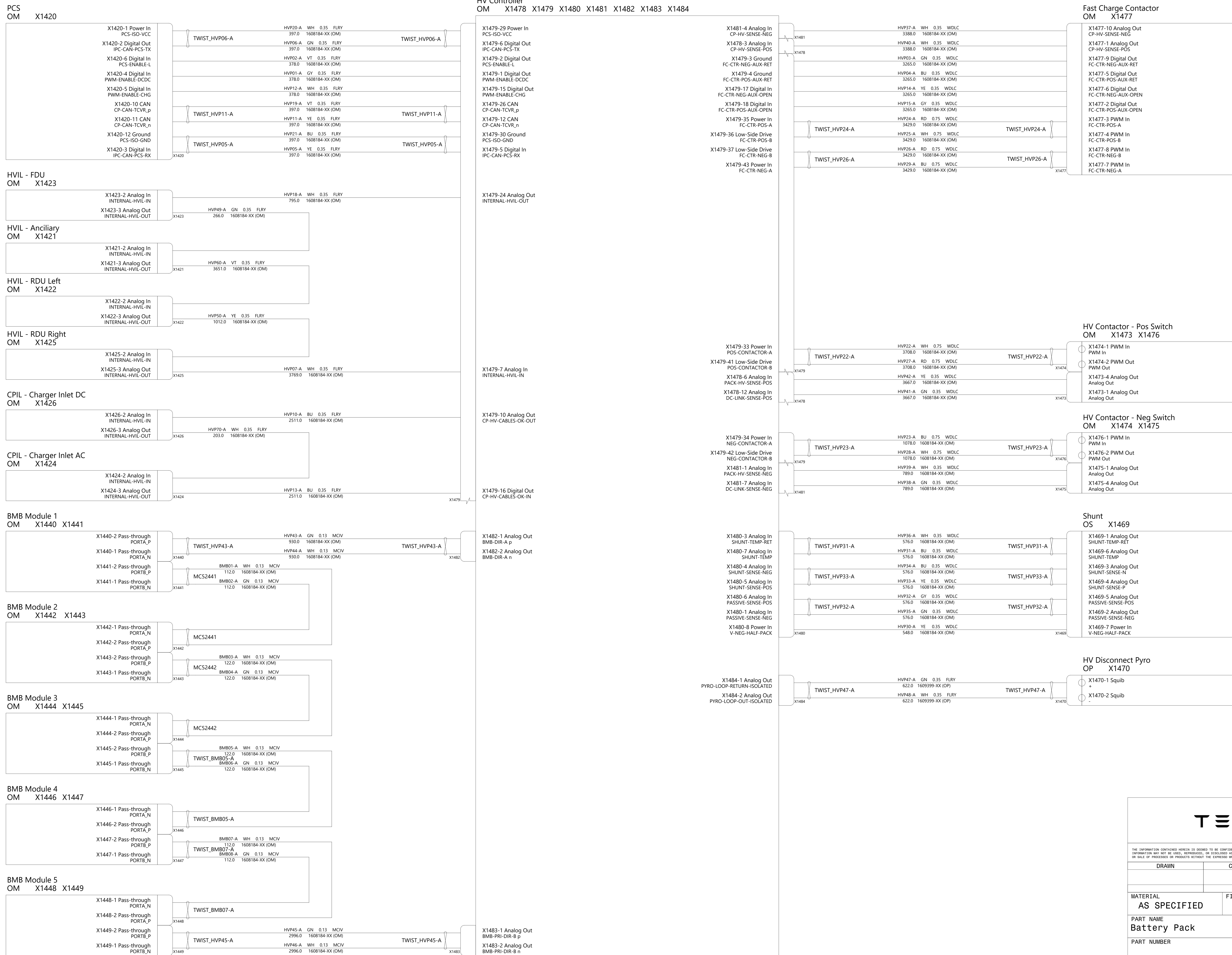

THE INFORMATION CONTAINED HEREIN IS DEEMED TO BE CONFIDENTIAL, PROPRIETARY, AND A TRADE SECRET OF TESLA MOTORS. THIS INFORMATION MAY NOT BE USED, REPRODUCED, OR DISCLOSED AS THE DIRECT OR INDIRECT BASIS FOR THE DEVELOPMENT, MANUFACTURE, OR SALE OF PROCESSES OR PRODUCTS WITHOUT THE EXPRESSED WRITTEN CONSENT OF TESLA MOTORS.

DRAWN	CHECKED	APPROVED
MATERIAL AS SPECIFIED	FINISHING AS SPECIFIED	SCALE NONE
PART NAME <b>Battery Pack</b>		
PART NUMBER	REV	SHEET
	1	8 of 61
		SIZE A0



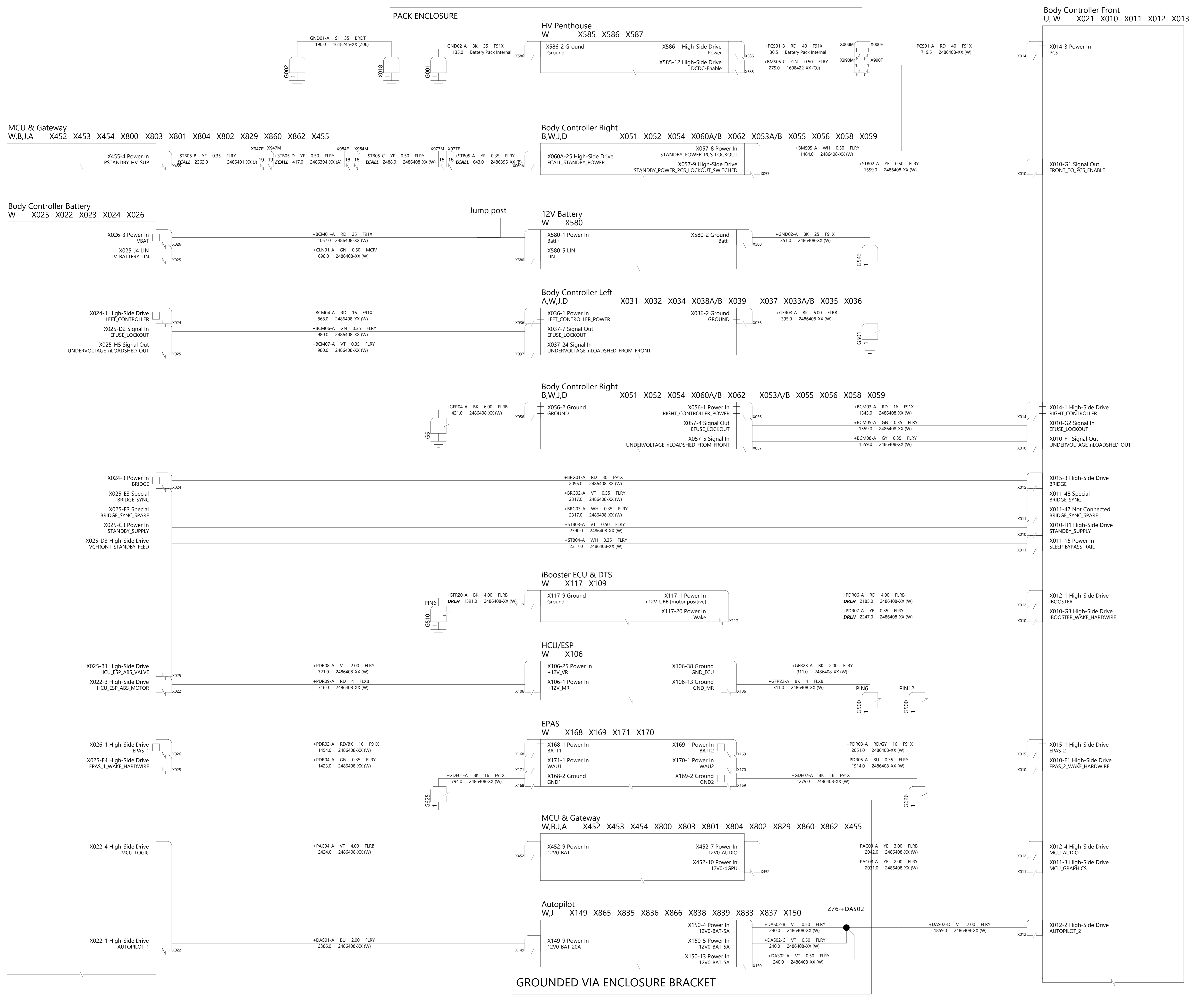

**TESLA**

THE INFORMATION CONTAINED HEREIN IS DEEMED TO BE CONFIDENTIAL, PROPRIETARY, AND A TRADE SECRET OF TESLA MOTORS. THIS INFORMATION MAY NOT BE USED, REPRODUCED, OR DISCLOSED AS THE DIRECT OR INDIRECT BASIS FOR THE DEVELOPMENT, MANUFACTURE, OR SALE OF PROCESSES OR PRODUCTS WITHOUT THE EXPRESSED WRITTEN CONSENT OF TESLA MOTORS.

DRAWN	CHECKED	APPROVED
MATERIAL AS SPECIFIED	FINISHING AS SPECIFIED	SCALE NONE
PART NAME Body Controllers: Main Distribution & Logic		
PART NUMBER	REV	SHEET
	1	9 OF 61
		SIZE A0

**Body Controller Battery**  
W X025 X022 X023 X024 X026

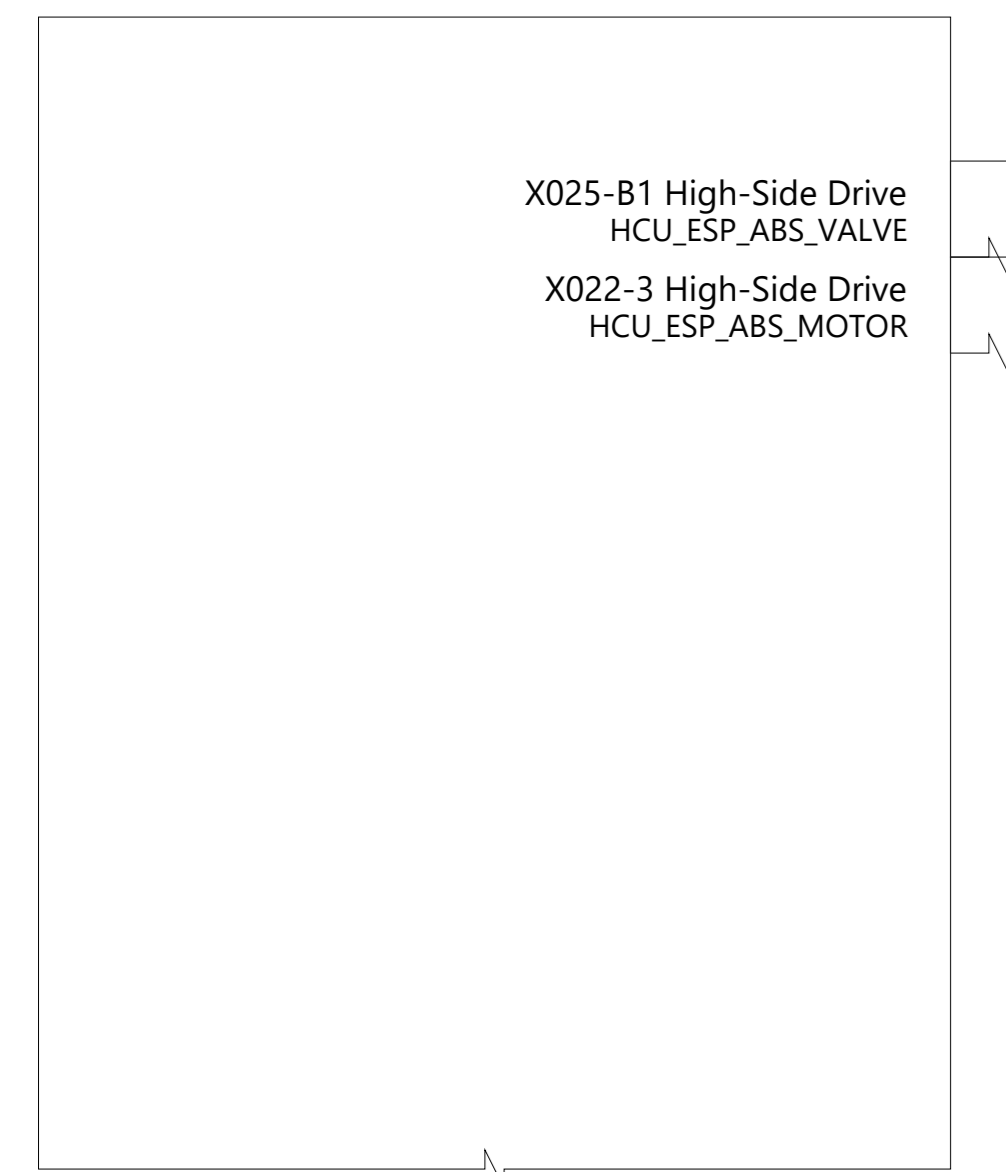

**HCU/ESP**  
W X106

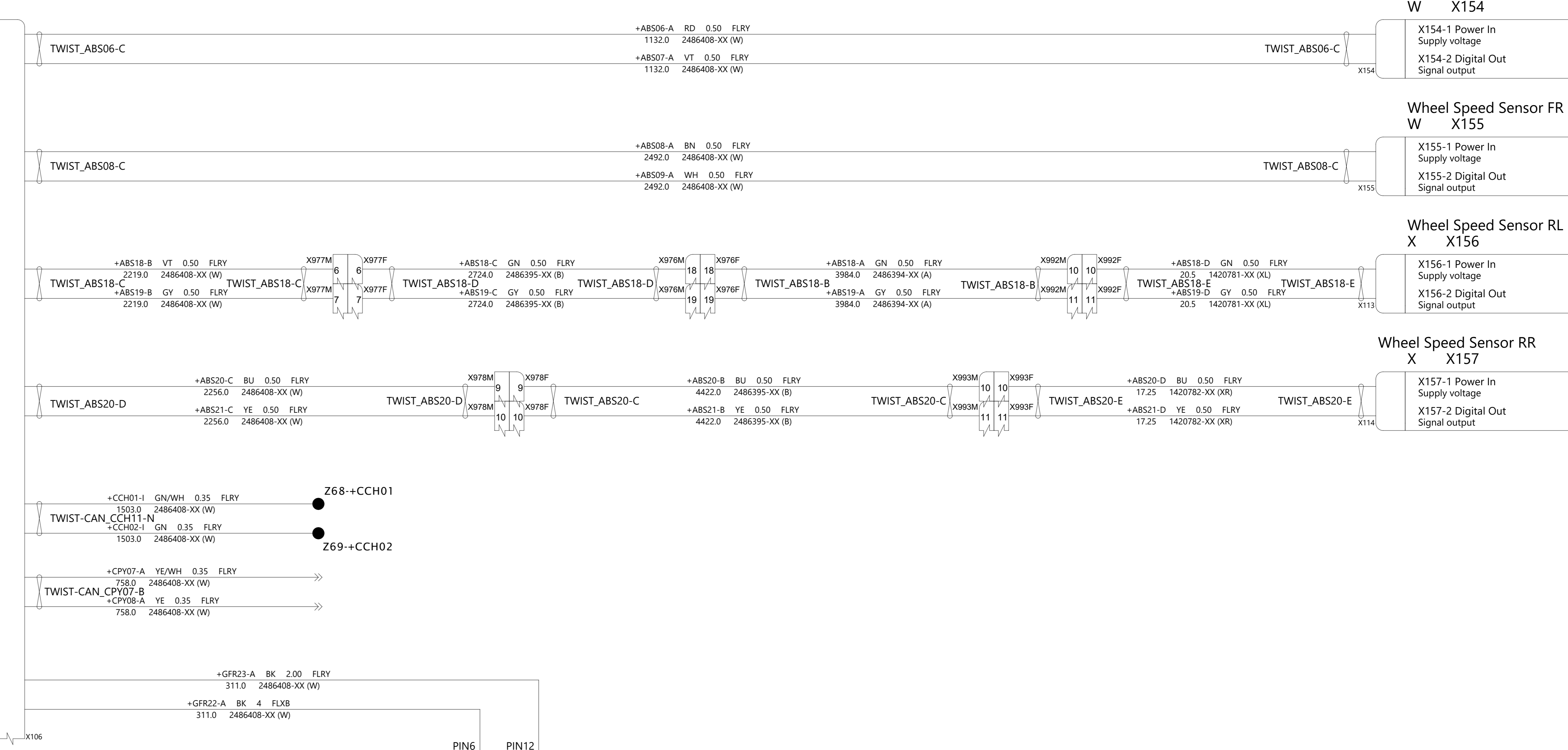
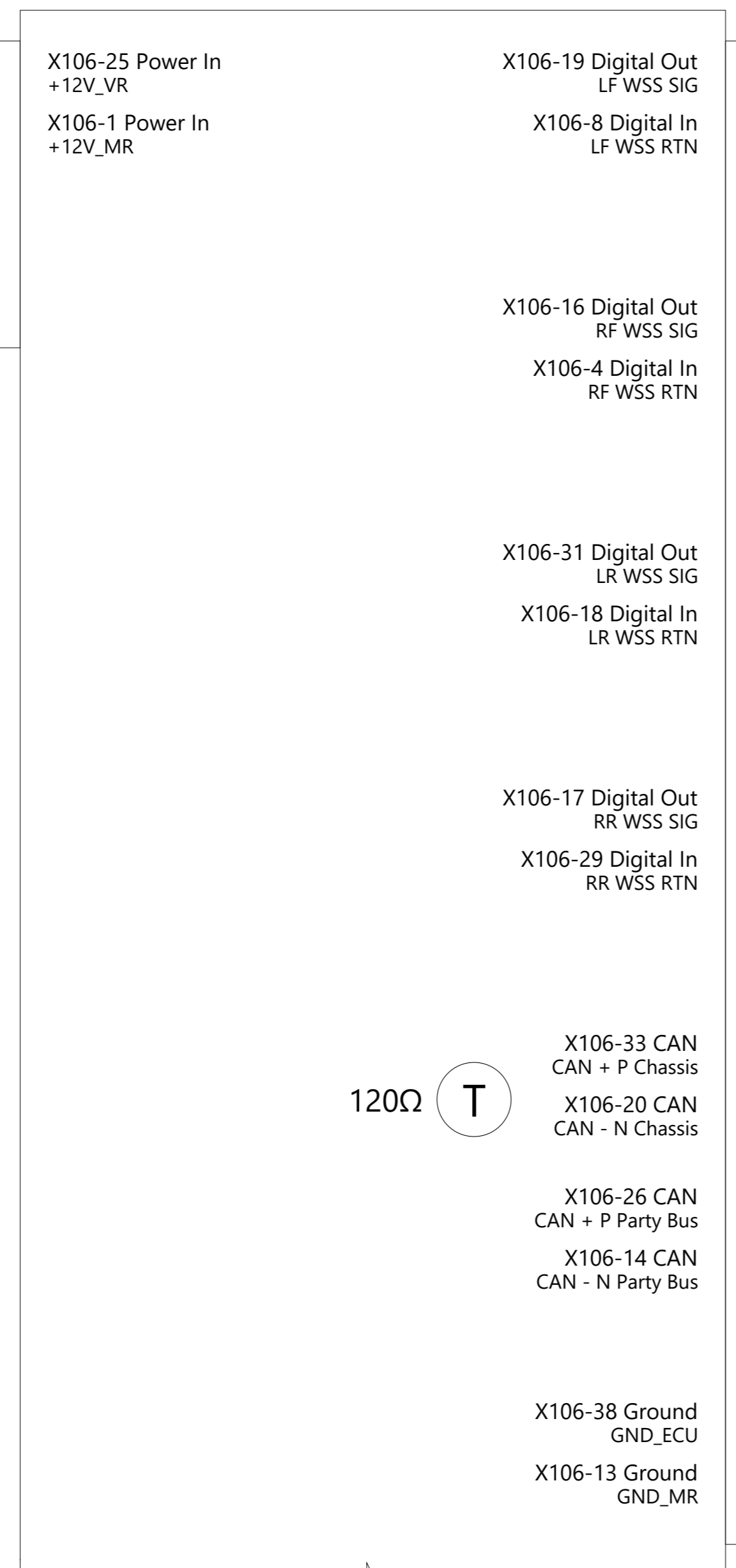

**Wheel Speed Sensor FL**  
W X154

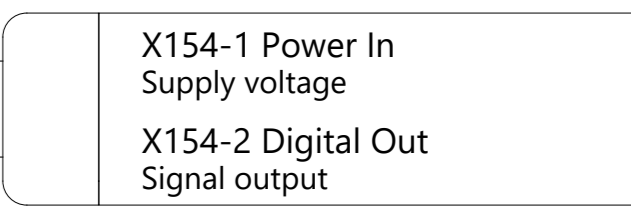

**Wheel Speed Sensor FR**  
W X155

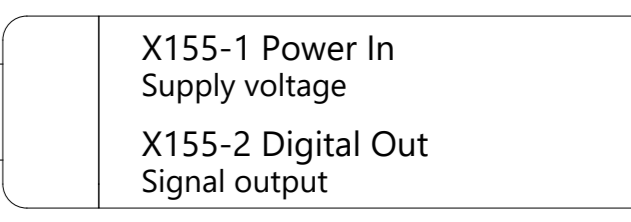

**Wheel Speed Sensor RL**  
X X156

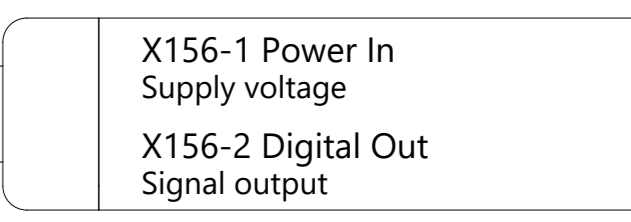

**Wheel Speed Sensor RR**  
X X157

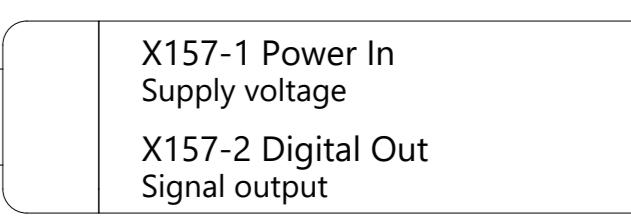

**Body Controller Front**  
U, W X021 X010 X011 X012 X013 X014

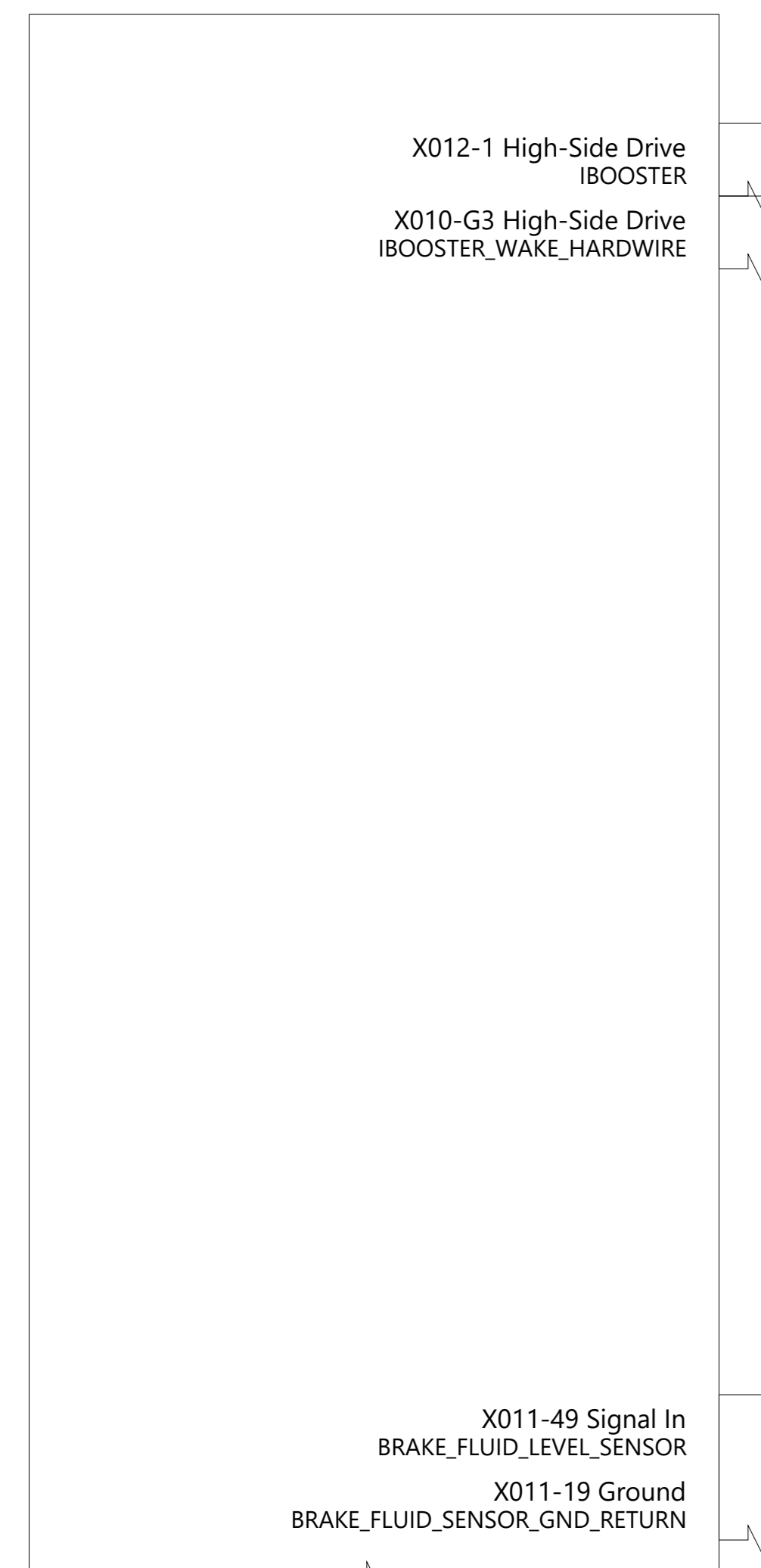

**DRLH**  
iBooster ECU & DTS  
W X117 X109

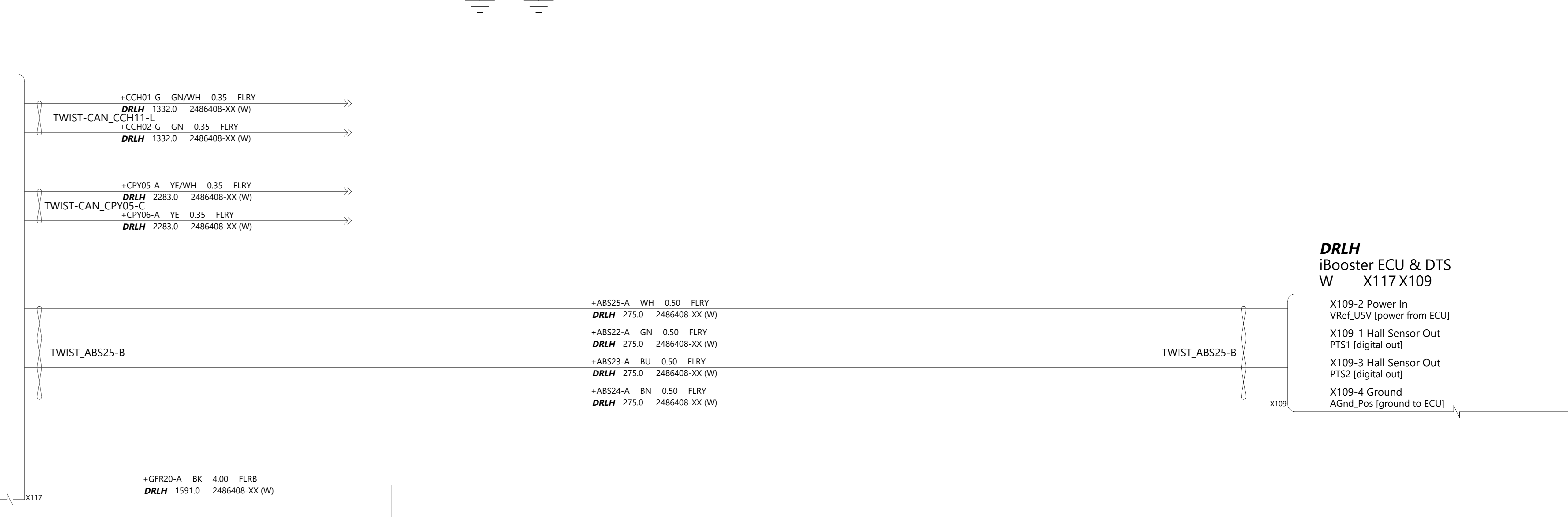
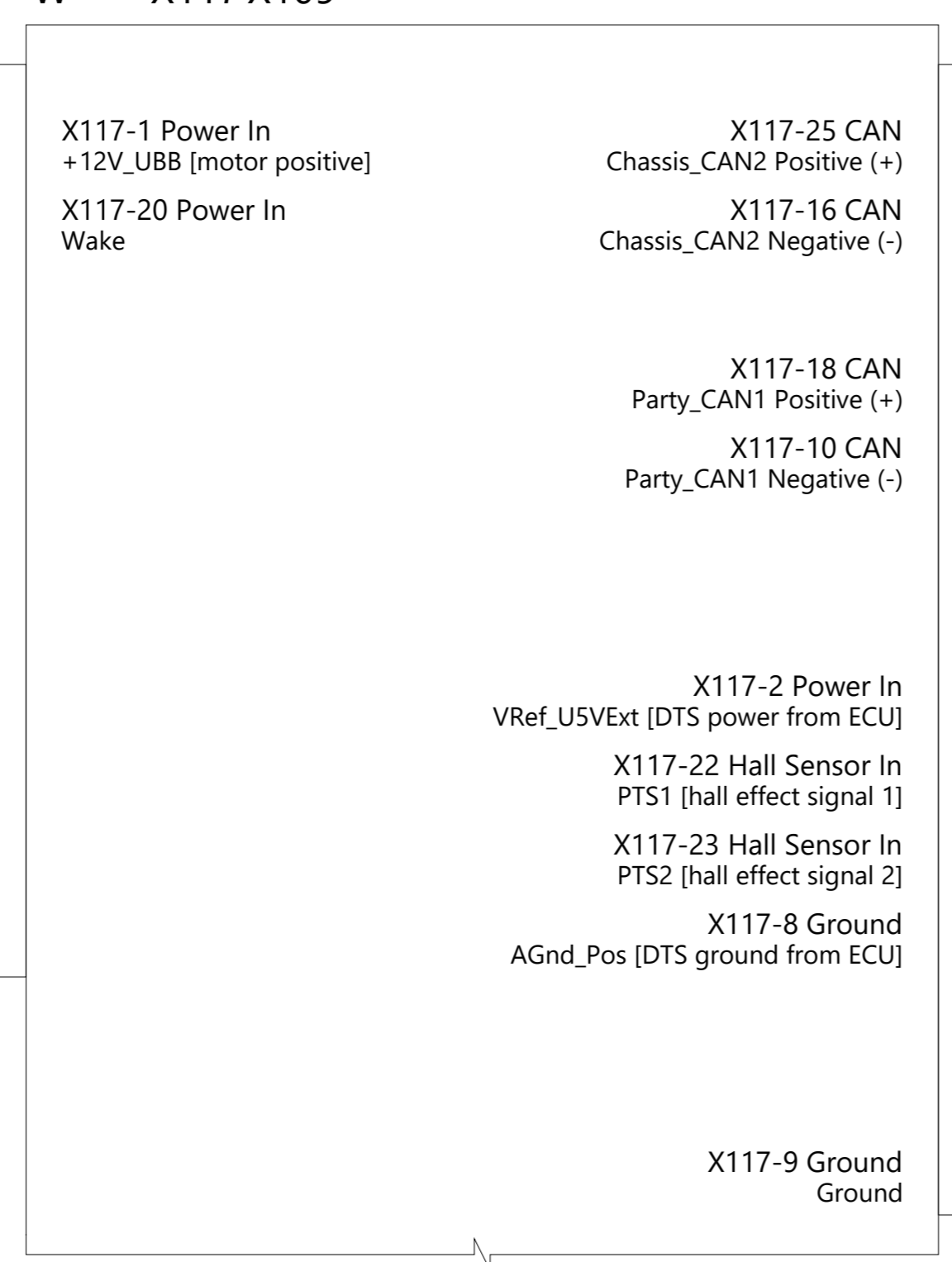

**DRLH || DRRH**  
Brake Fluid Level  
W X115

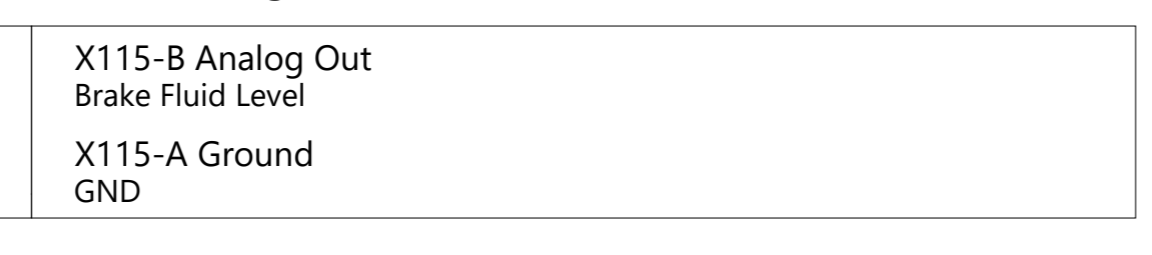

**Body Controller Left**  
A,W,J,D X031 X032 X034 X038A/B X039 X037 X033A/B X035 X036

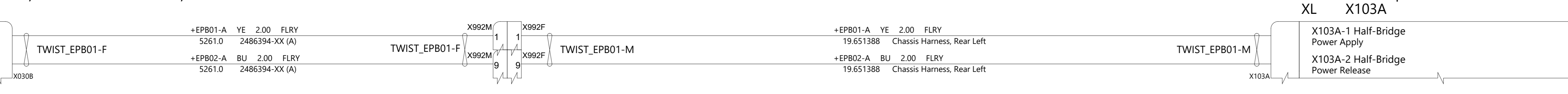
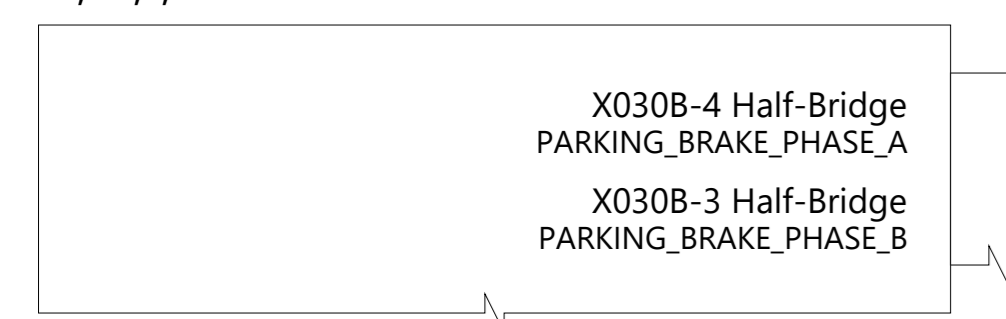

**Body Controller Right**  
B,W,J,D X051 X052 X054 X060A/B X062 X053A/B X055 X056 X058 X059

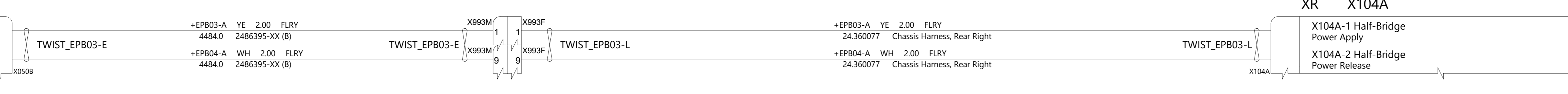

THE INFORMATION CONTAINED HEREIN IS DEEMED TO BE CONFIDENTIAL, PROPRIETARY, AND A TRADE SECRET OF TESLA MOTORS. THIS INFORMATION MAY NOT BE USED, REPRODUCED, OR DISCLOSED AS THE DIRECT OR INDIRECT BASIS FOR THE DEVELOPMENT, MANUFACTURE, OR SALE OF PROCESSES OR PRODUCTS WITHOUT THE EXPRESS WRITTEN CONSENT OF TESLA MOTORS.

DRAWN	CHECKED	APPROVED
MATERIAL AS SPECIFIED	FINISHING AS SPECIFIED	SCALE NONE
PART NAME Braking & Stability		
PART NUMBER	REV 1	SHEET 10 of 61
		SIZE A0

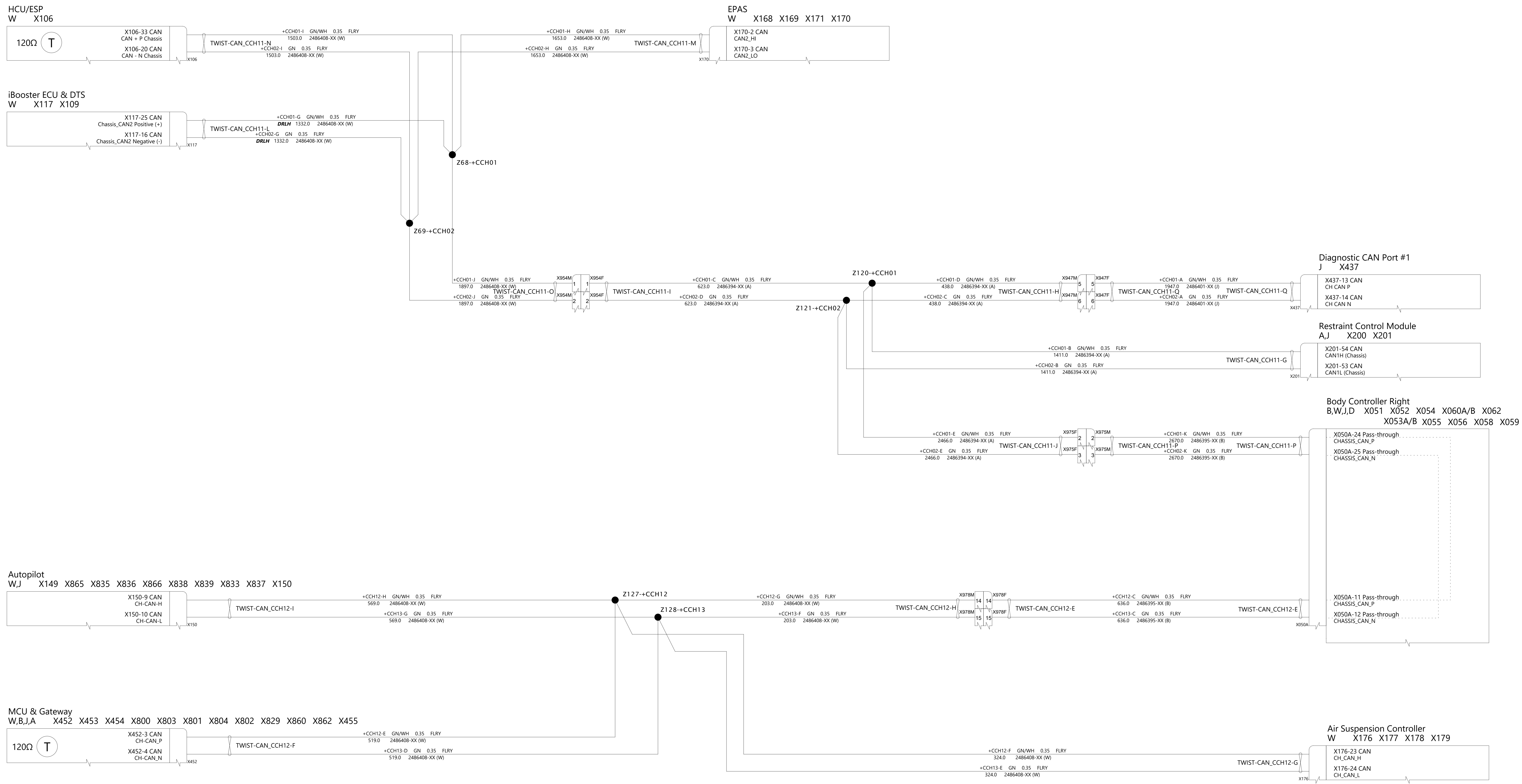

**TESLA**

THE INFORMATION CONTAINED HEREIN IS DEEMED TO BE CONFIDENTIAL, PROPRIETARY, AND A TRADE SECRET OF TESLA MOTORS. THIS INFORMATION MAY NOT BE USED, REPRODUCED, OR DISCLOSED AS THE DIRECT OR INDIRECT BASIS FOR THE DEVELOPMENT, MANUFACTURE, OR SALE OF PROCESSES OR PRODUCTS WITHOUT THE EXPRESSED WRITTEN CONSENT OF TESLA MOTORS.

DRAWN	CHECKED	APPROVED
-------	---------	----------

MATERIAL AS SPECIFIED	FINISHING AS SPECIFIED	SCALE NONE
--------------------------	---------------------------	---------------

PART NAME  
**CAN Network: Chassis**

PART NUMBER	REV	SHEET	SIZE
	1	11 OF 61	A0

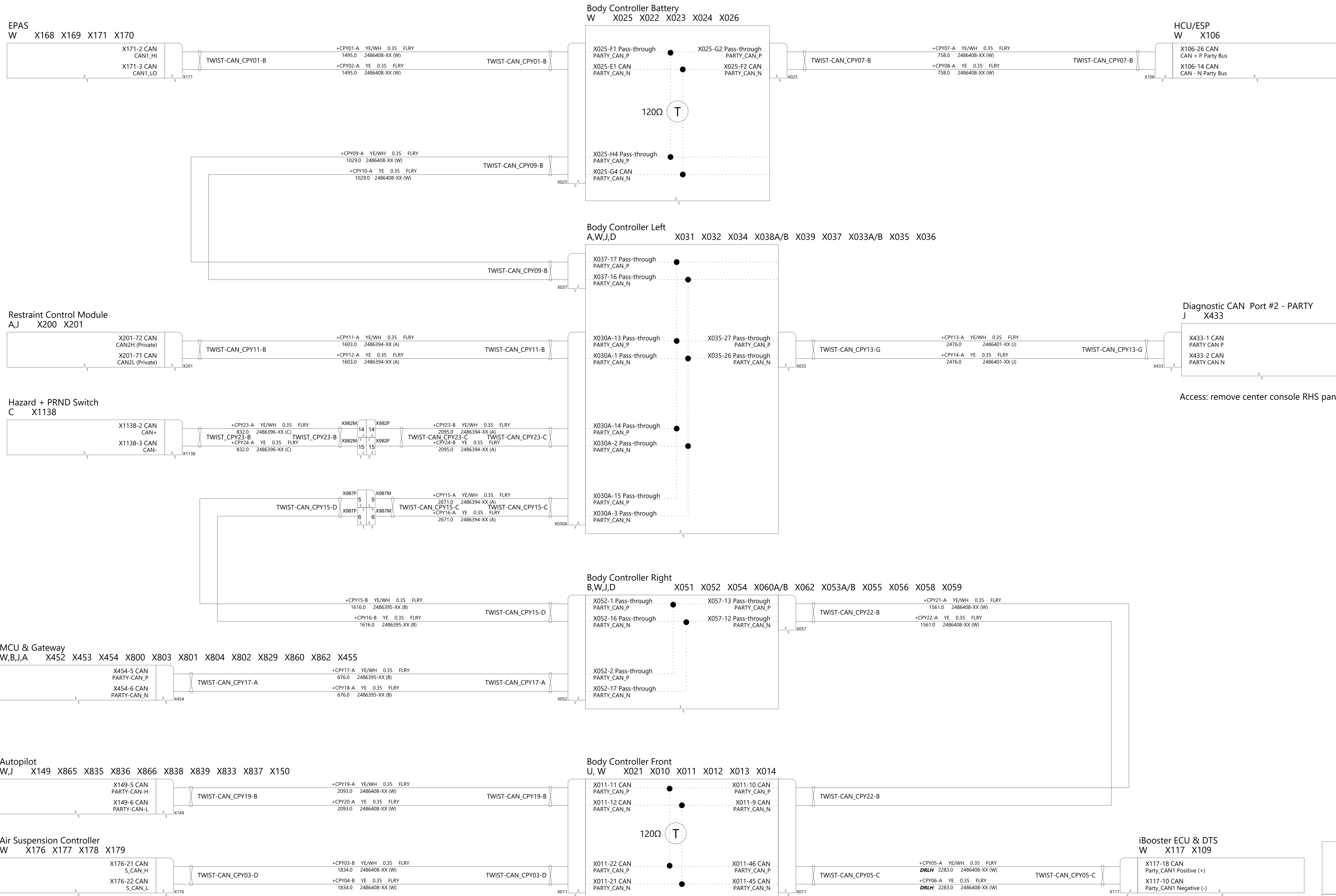

Access: remove center console RHS panel



THE INFORMATION CONTAINED HEREIN IS DEEMED TO BE CONFIDENTIAL, PROPRIETARY, AND A TRADE SECRET OF TESLA MOTORS. THIS INFORMATION MAY NOT BE USED, REPRODUCED, OR DISCLOSED AS THE DIRECT OR INDIRECT BASIS FOR THE DEVELOPMENT, MANUFACTURE, OR SALE OF PROCESSES OR PRODUCTS WITHOUT THE EXPRESSED WRITTEN CONSENT OF TESLA MOTORS.

DRAWN	CHECKED	APPROVED
MATERIAL AS SPECIFIED	FINISHING AS SPECIFIED	SCALE NONE
PART NAME CAN Network: Party		
PART NUMBER	REV	SHEET
	1	12 of 61
		SIZE A0

Body Controller Right  
B,W,J,D X051 X052 X054 X060A/B X062 X053A/B X055 X056 X058 X059

Body Controller Battery  
W X025 X022 X023 X024 X026

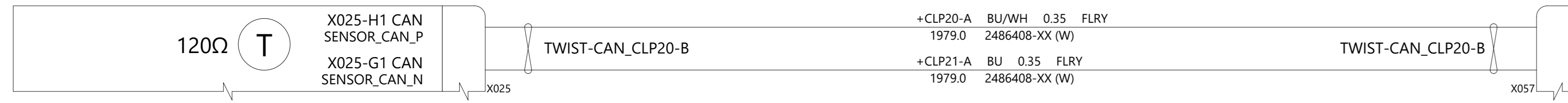

Security Controller  
B X488

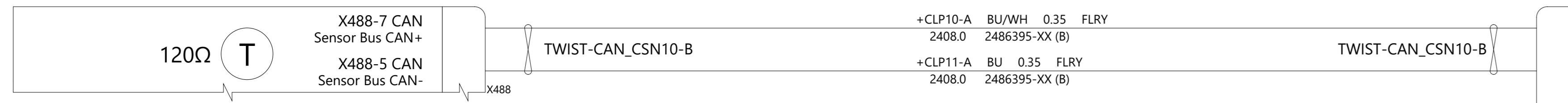

Radar - Interior  
B X400

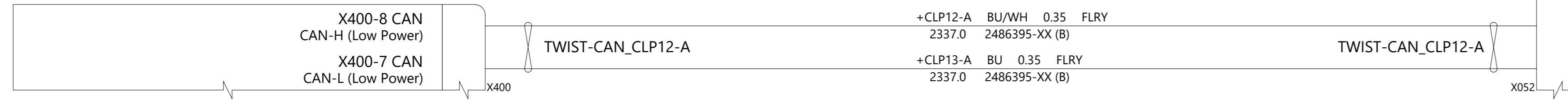

Diagnostic CAN Port #1  
J X437

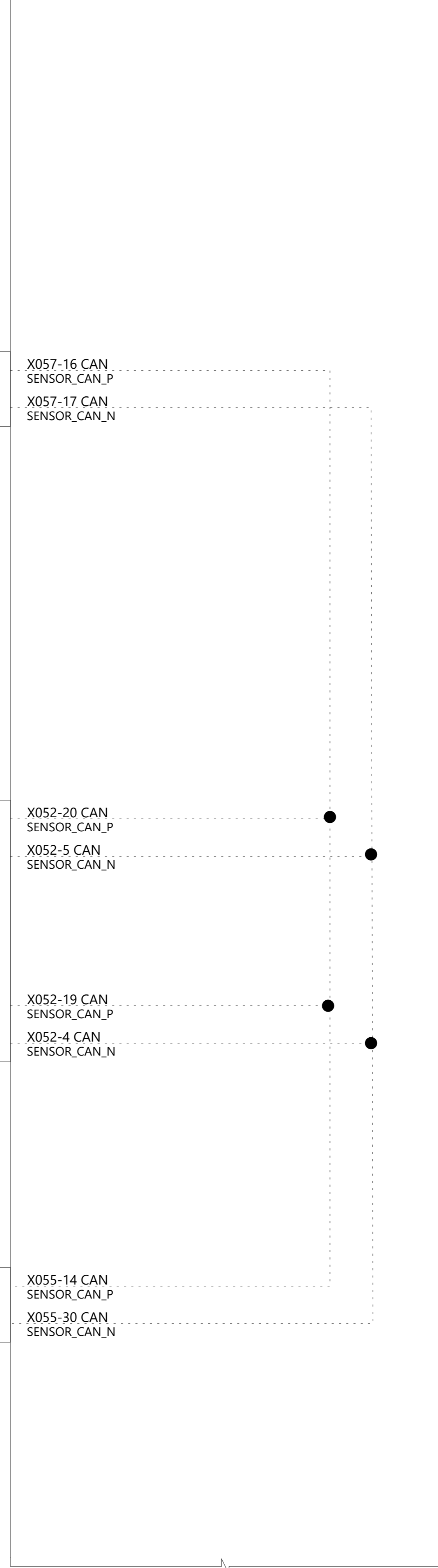
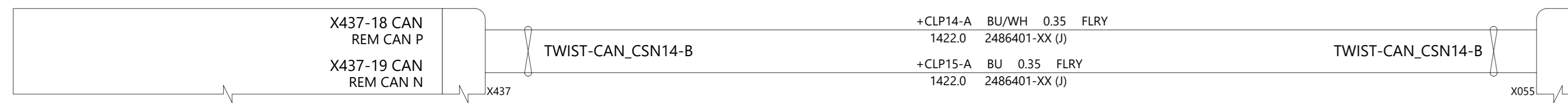

**TESLA**

THE INFORMATION CONTAINED HEREIN IS DEEMED TO BE CONFIDENTIAL, PROPRIETARY, AND A TRADE SECRET OF TESLA MOTORS. THIS INFORMATION MAY NOT BE USED, REPRODUCED, OR DISCLOSED AS THE DIRECT OR INDIRECT BASIS FOR THE DEVELOPMENT, MANUFACTURE, OR SALE OF PROCESSES OR PRODUCTS WITHOUT THE EXPRESSED WRITTEN CONSENT OF TESLA MOTORS.

DRAWN	CHECKED	APPROVED
-------	---------	----------

MATERIAL AS SPECIFIED	FINISHING AS SPECIFIED	SCALE NONE
--------------------------	---------------------------	---------------

PART NAME  
CAN Network: REM

PART NUMBER	REV 1	SHEET 13 of 61	SIZE A0
-------------	----------	-------------------	------------

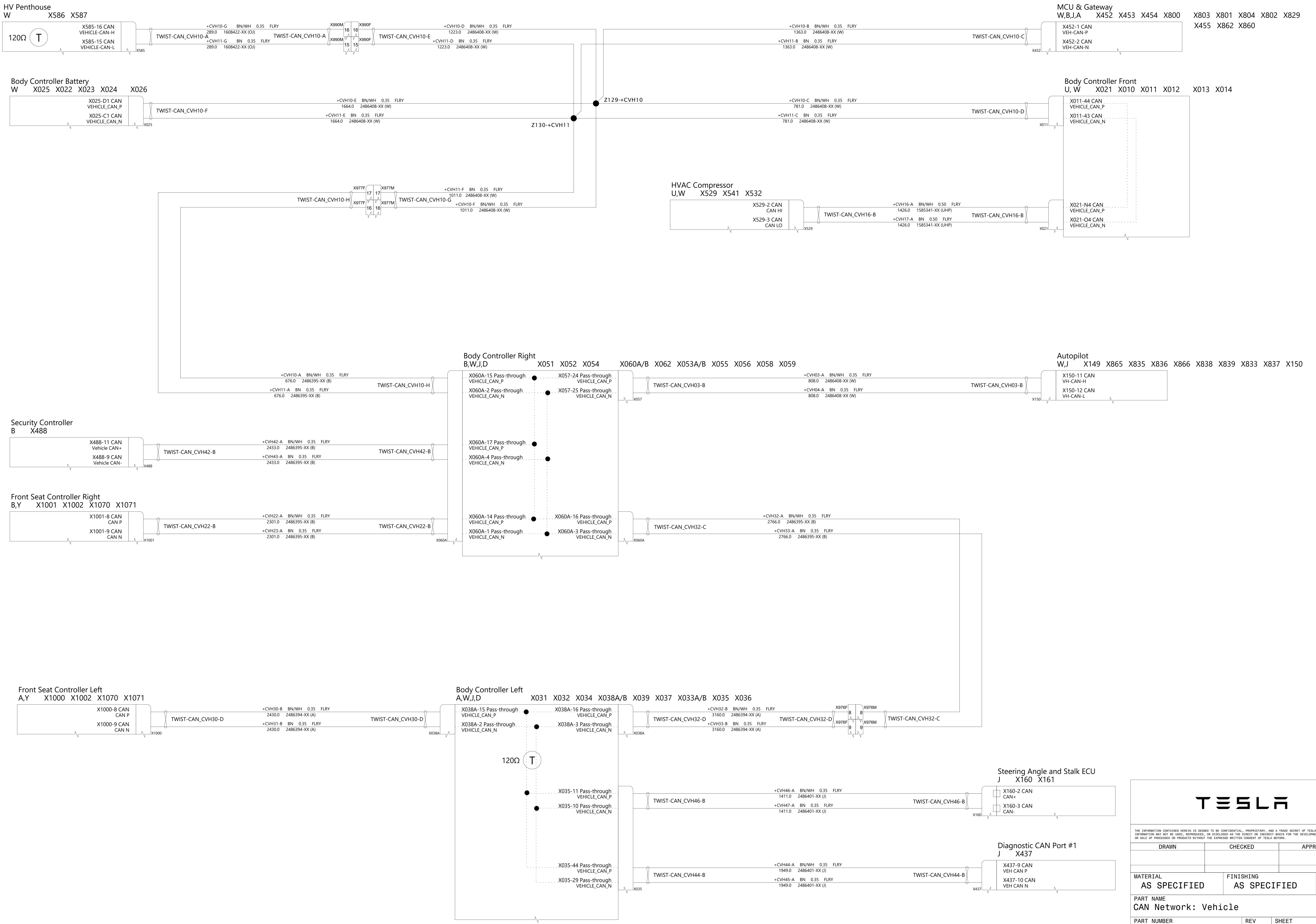

THE INFORMATION CONTAINED HEREIN IS DEEMED TO BE CONFIDENTIAL, PROPRIETARY, AND A TRADE SECRET OF TESLA MOTORS. THIS INFORMATION MAY NOT BE USED, REPRODUCED, OR DISCLOSED AS THE DIRECT OR INDIRECT BASIS FOR THE DEVELOPMENT, MANUFACTURE, OR SALE OF PROCESSES OR PRODUCTS WITHOUT THE EXPRESSED WRITTEN CONSENT OF TESLA MOTORS.

DRAWN	CHECKED	APPROVED
MATERIAL AS SPECIFIED	FINISHING AS SPECIFIED	SCALE NONE
PART NAME CAN Network: Vehicle		
PART NUMBER	REV	SHEET
	1	14 of 61
		SCALE A0

Body Controller Left  
A,W,J,D

X031 X032 X034 X038A/B X039 X037 X033A/B X035 X036

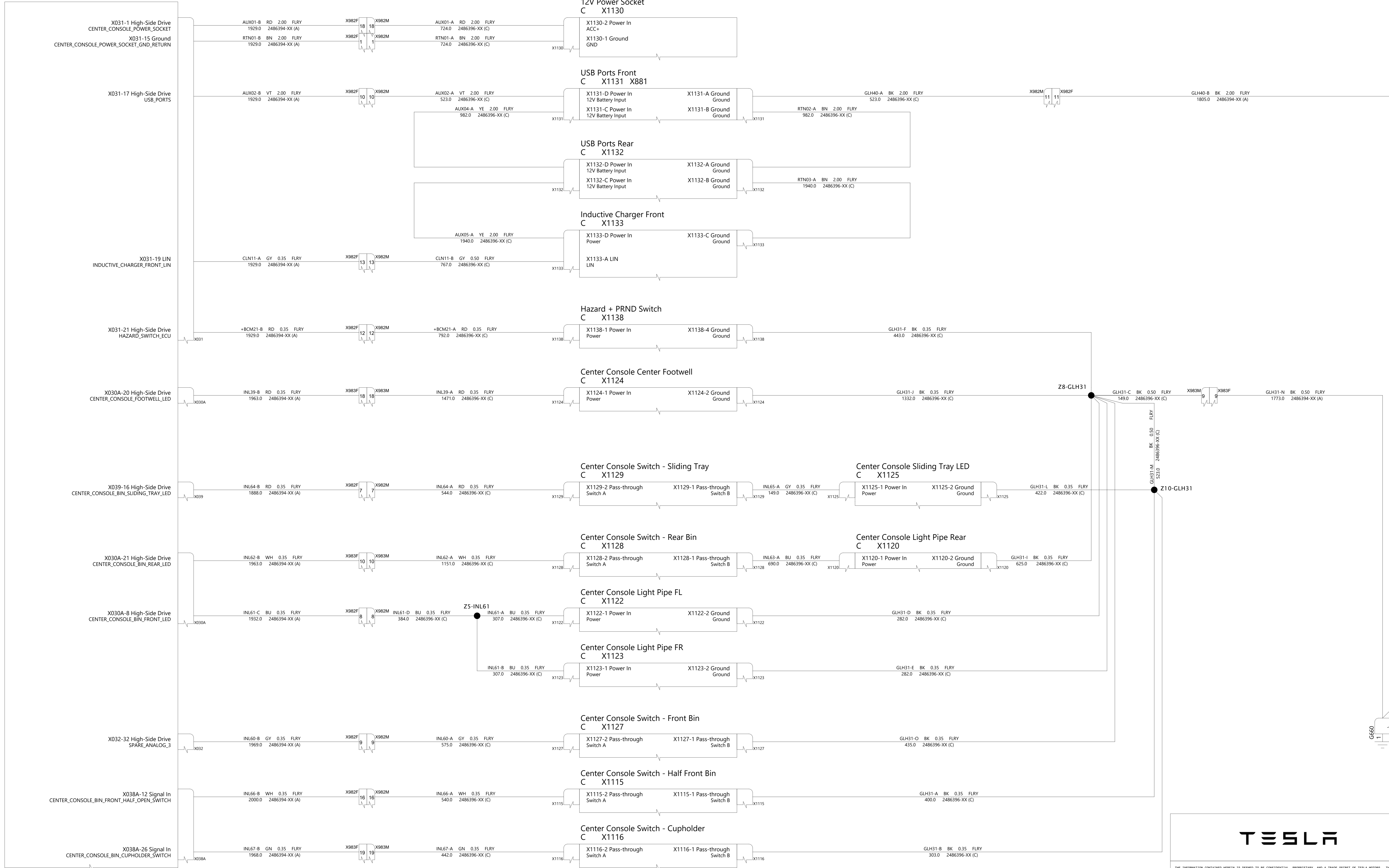

THE INFORMATION CONTAINED HEREIN IS DEEMED TO BE CONFIDENTIAL, PROPRIETARY, AND A TRADE SECRET OF TESLA MOTORS. THIS INFORMATION MAY NOT BE USED, REPRODUCED, OR DISCLOSED AS THE DIRECT OR INDIRECT BASIS FOR THE DEVELOPMENT, MANUFACTURE, OR SALE OF PROCESSES OR PRODUCTS WITHOUT THE EXPRESSED WRITTEN CONSENT OF TESLA MOTORS.

DRAWN	CHECKED	APPROVED
-------	---------	----------

MATERIAL AS SPECIFIED	FINISHING AS SPECIFIED	SCALE NONE
--------------------------	---------------------------	---------------

PART NAME  
**Center Console**

PART NUMBER	REV	SHEET	SIZE
	1	15 of 61	A0

Body Controller Left  
A,W,J,D X031 X032 X034 X038A/B X039 X037 X033A/B X035 X036



HV Penthouse  
W X586 X587

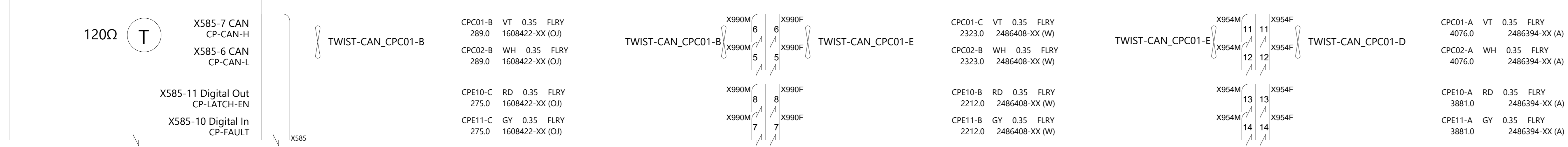

Charge Port ECU  
A X049 X048 X047

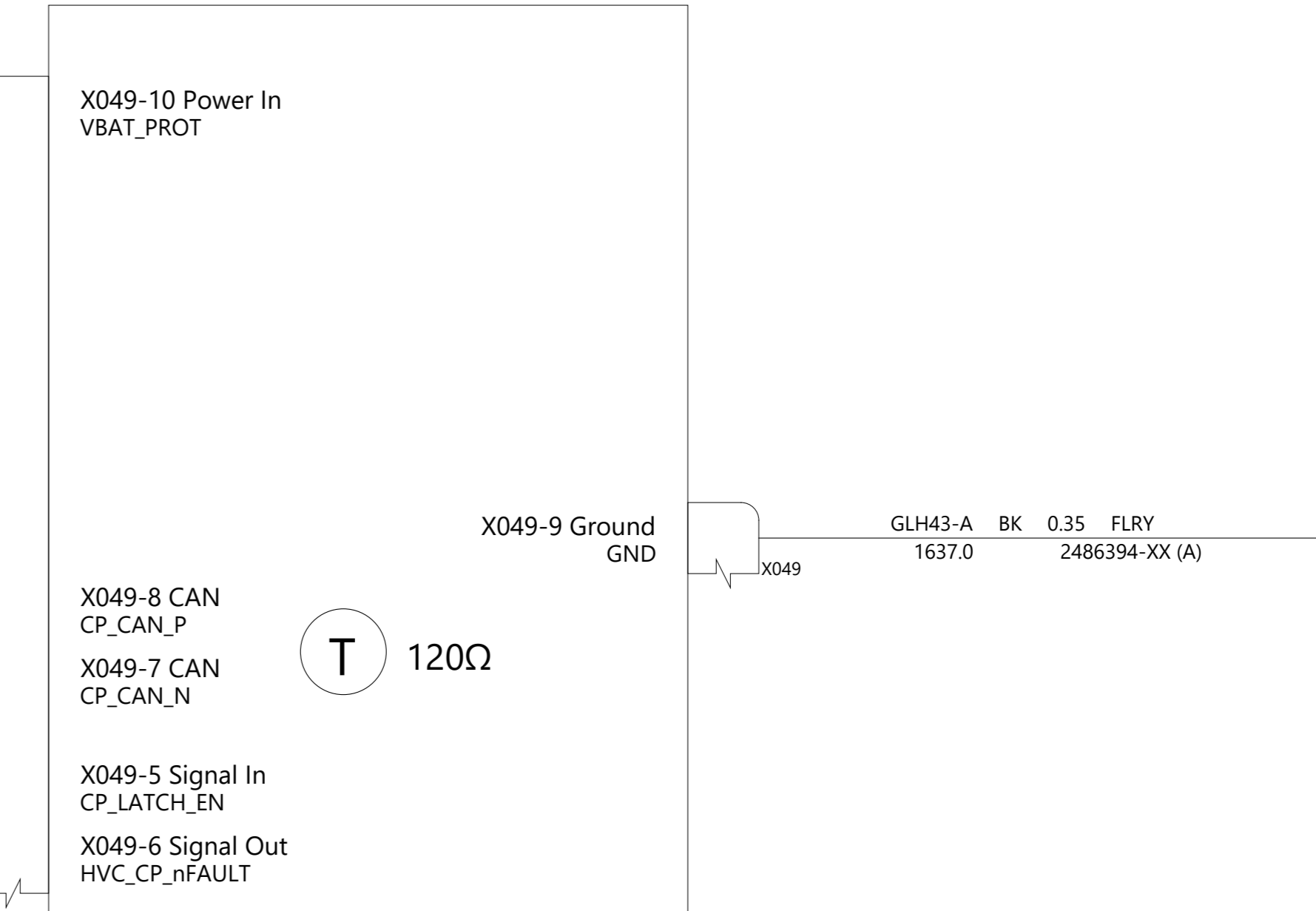

Charge Port Inlet  
A

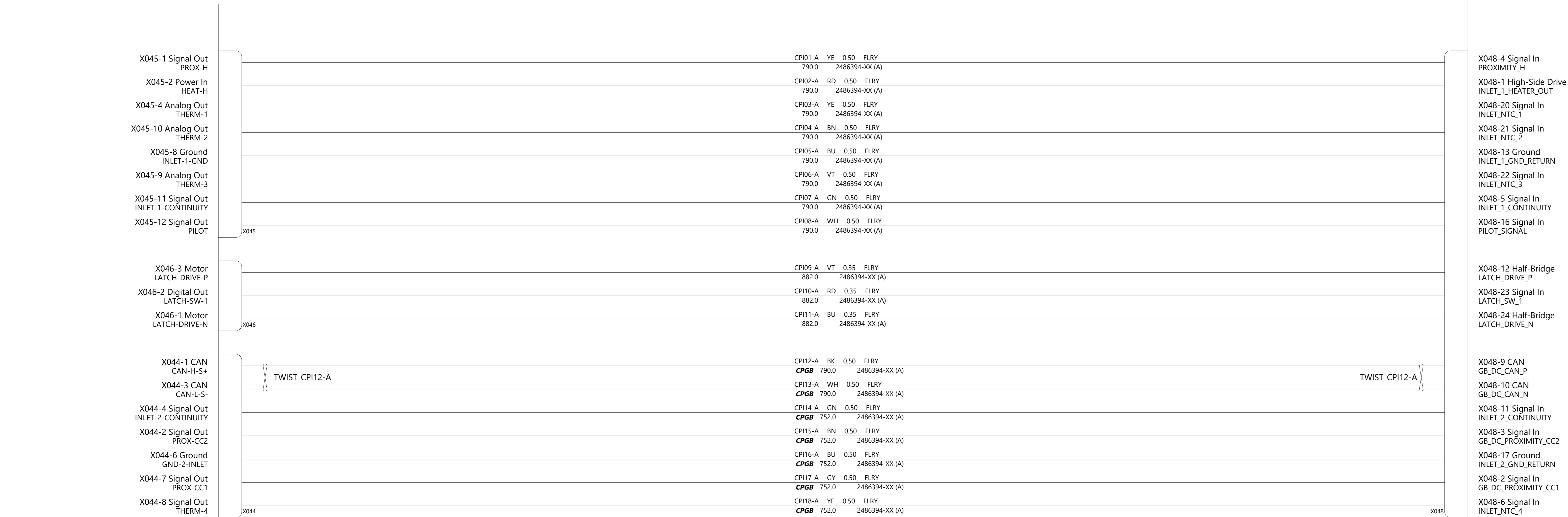

Charge Port Door  
Charge Port Door Subassembly CP02 CP03 CP04

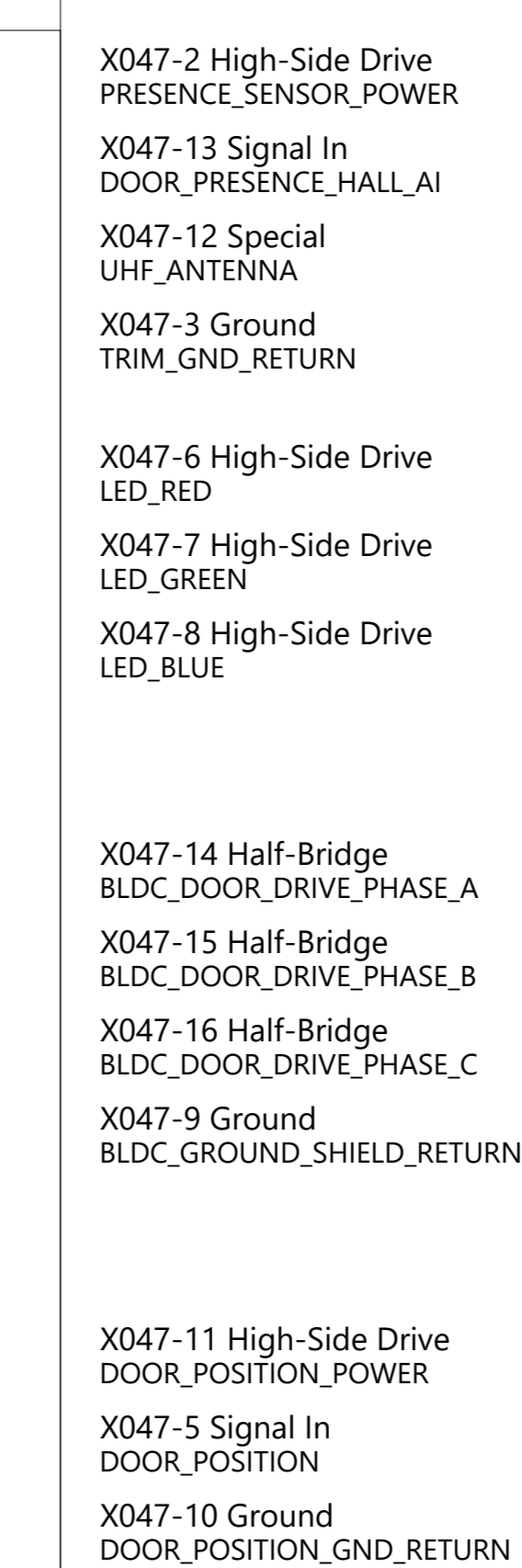
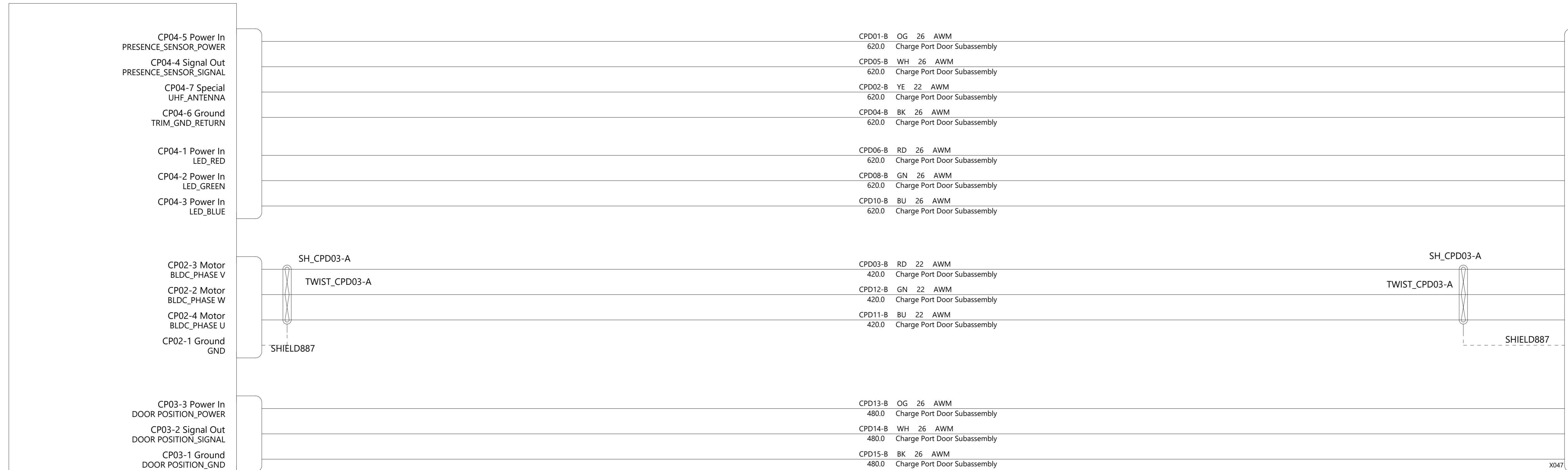

THE INFORMATION CONTAINED HEREIN IS DEEMED TO BE CONFIDENTIAL, PROPRIETARY, AND A TRADE SECRET OF TESLA MOTORS. THIS INFORMATION MAY NOT BE USED, REPRODUCED, OR DISCLOSED AS THE DIRECT OR INDIRECT BASIS FOR THE DEVELOPMENT, MANUFACTURE, OR SALE OF PROCESSES OR PRODUCTS WITHOUT THE EXPRESS WRITTEN CONSENT OF TESLA MOTORS.			
DRAWN	CHECKED	APPROVED	
MATERIAL AS SPECIFIED	FINISHING AS SPECIFIED	SCALE NONE	
PART NAME Charge Port			
PART NUMBER	REV	SHEET	SIZE
	1	16 of 61	A0



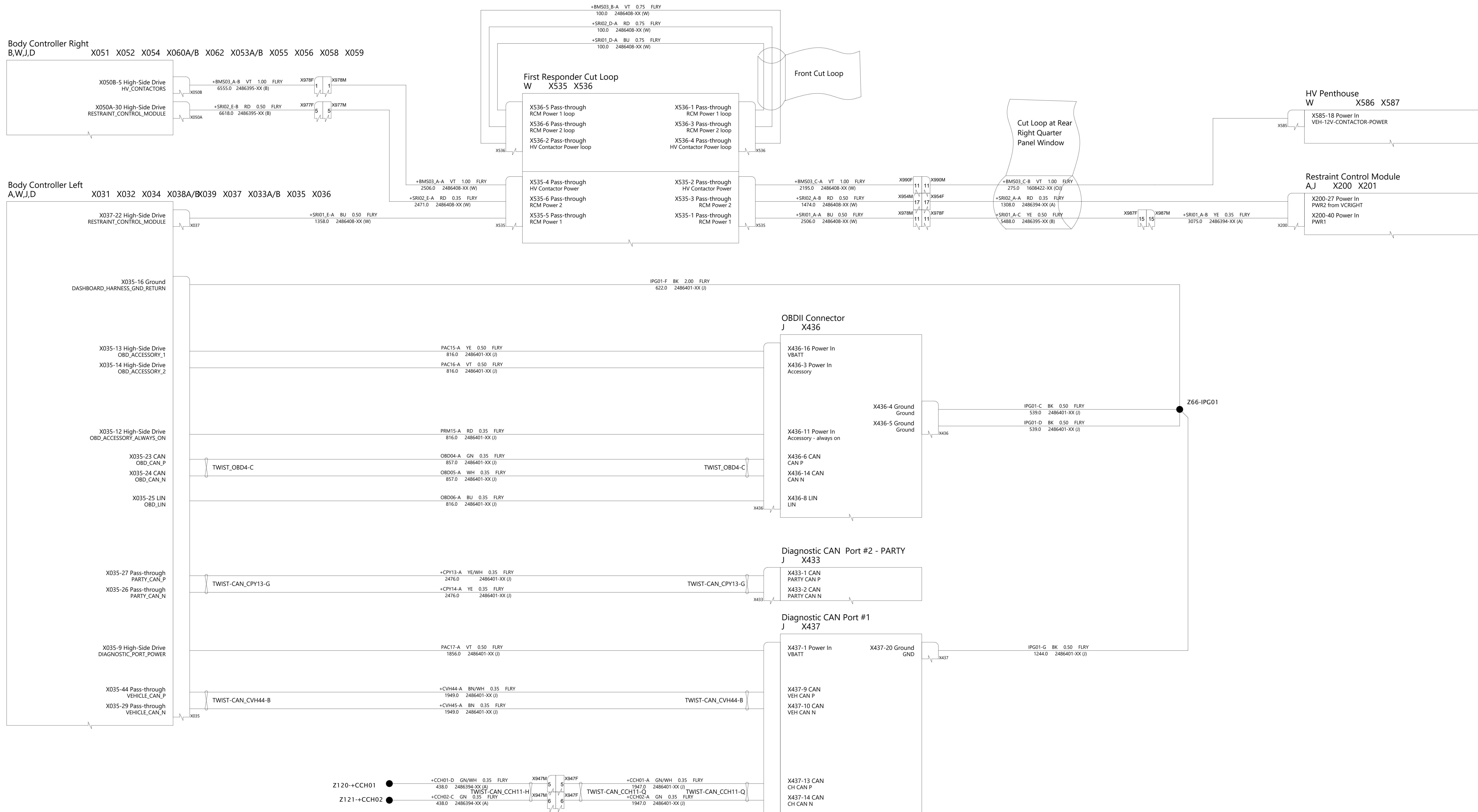

THE INFORMATION CONTAINED HEREIN IS DEEMED TO BE CONFIDENTIAL, PROPRIETARY, AND A TRADE SECRET OF TESLA MOTORS. THIS INFORMATION MAY NOT BE USED, REPRODUCED, OR DISCLOSED AS THE DIRECT OR INDIRECT BASIS FOR THE DEVELOPMENT, MANUFACTURE, OR SALE OF PROCESSES OR PRODUCTS WITHOUT THE EXPRESSED WRITTEN CONSENT OF TESLA MOTORS.

DRAWN	CHECKED	APPROVED
MATERIAL AS SPECIFIED		SCALE NONE
FINISHING AS SPECIFIED		
PART NAME Diagnostics & Cut Loop		
PART NUMBER	REV	SHEET
	1	17 OF 61
		SIZE A0

# Shared door trim harness between Front Left & Front Right doors

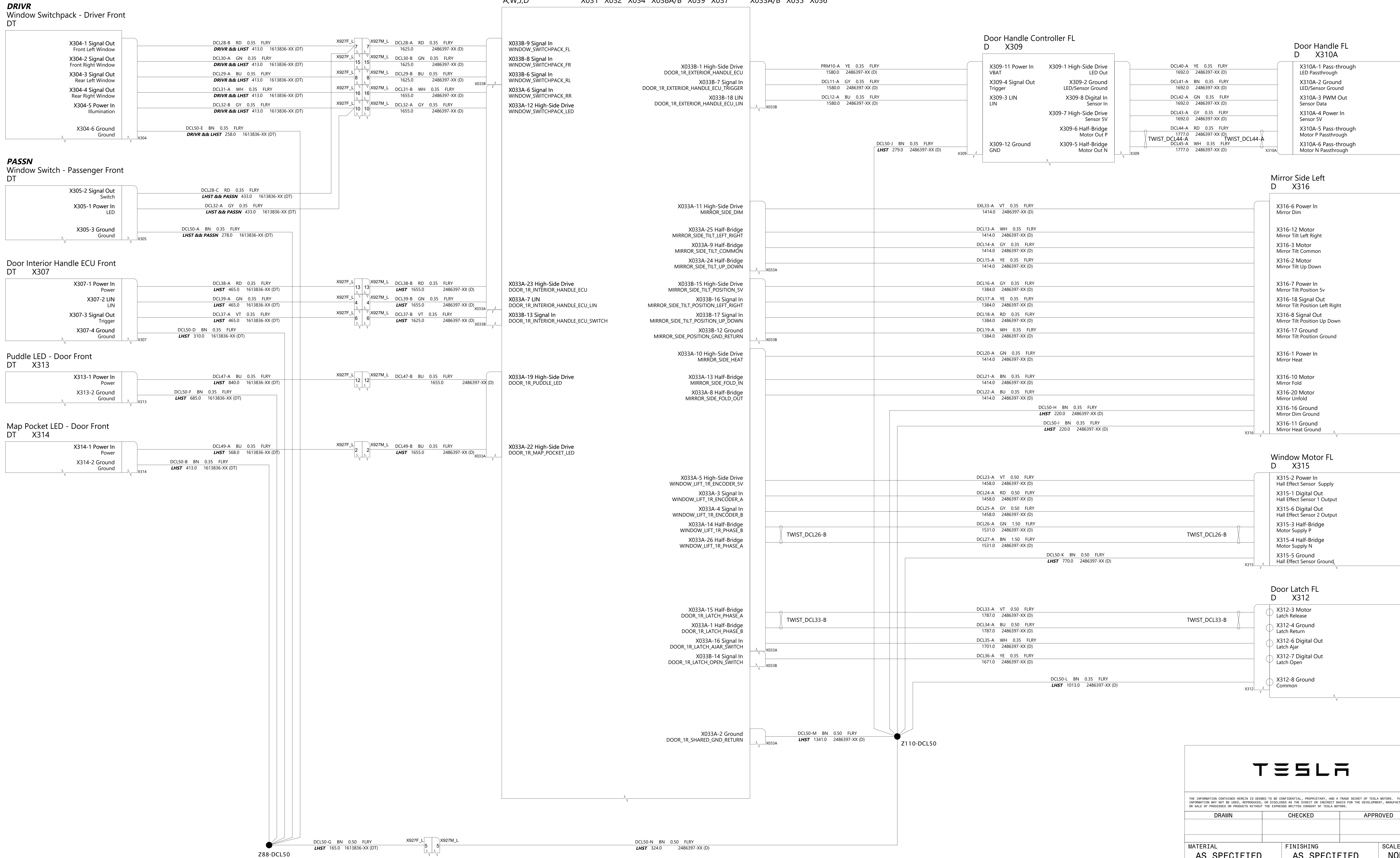

THE INFORMATION CONTAINED HEREIN IS DEEMED TO BE CONFIDENTIAL, PROPRIETARY, AND A TRADE SECRET OF TESLA MOTORS. THIS INFORMATION MAY NOT BE USED, REPRODUCED, OR DISCLOSED AS THE DIRECT OR INDIRECT BASIS FOR THE DEVELOPMENT, MANUFACTURE, OR SALE OF PROCESSES OR PRODUCTS WITHOUT THE EXPRESSED WRITTEN CONSENT OF TESLA MOTORS.

DRAWN	CHECKED	APPROVED
MATERIAL AS SPECIFIED	FINISHING AS SPECIFIED	SCALE NONE
PART NAME Door Front Left		
PART NUMBER	REV	SHEET
	1	18 of 61
		SIZE
		A0

**DRIVR**  
Window Switchpack - Driver Front  
DT

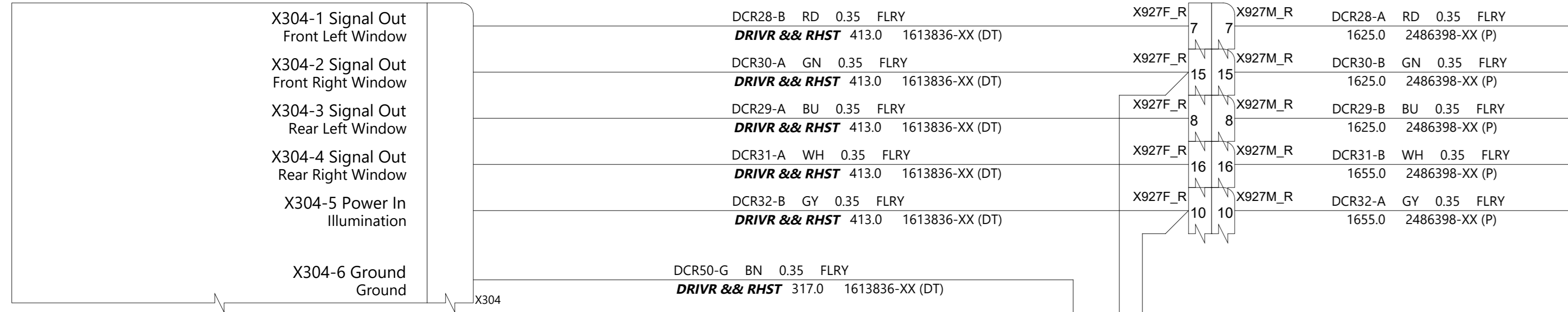

**PASSN**  
Window Switch - Passenger Front  
DT

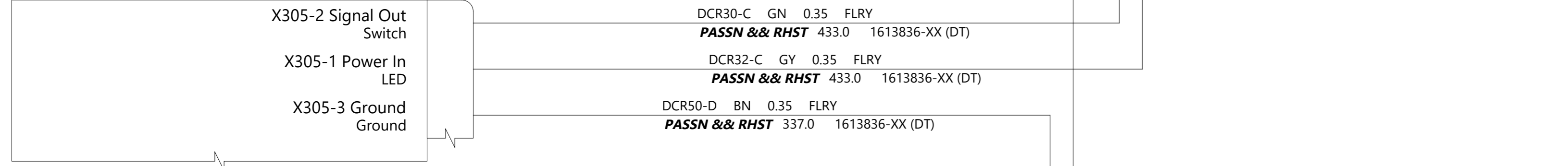

**Door Interior Handle ECU Front**  
DT X307

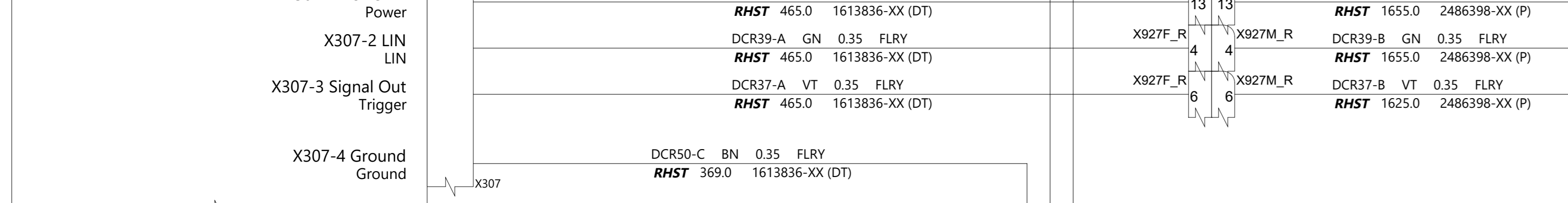

**Puddle LED - Door Front**  
DT X313

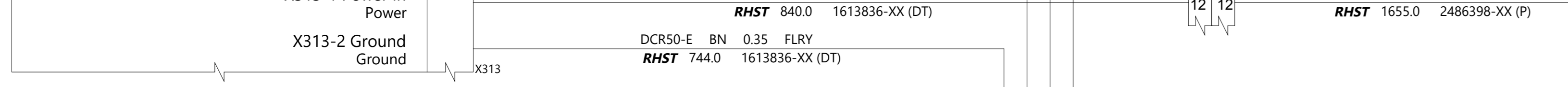

**Map Pocket LED - Door Front**  
DT X314

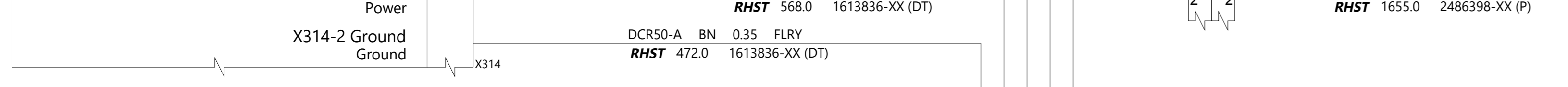

**Body Controller Right**  
B,W,J,D X051 X052 X054 X060A/B X062 X053A/B X056 X058 X059

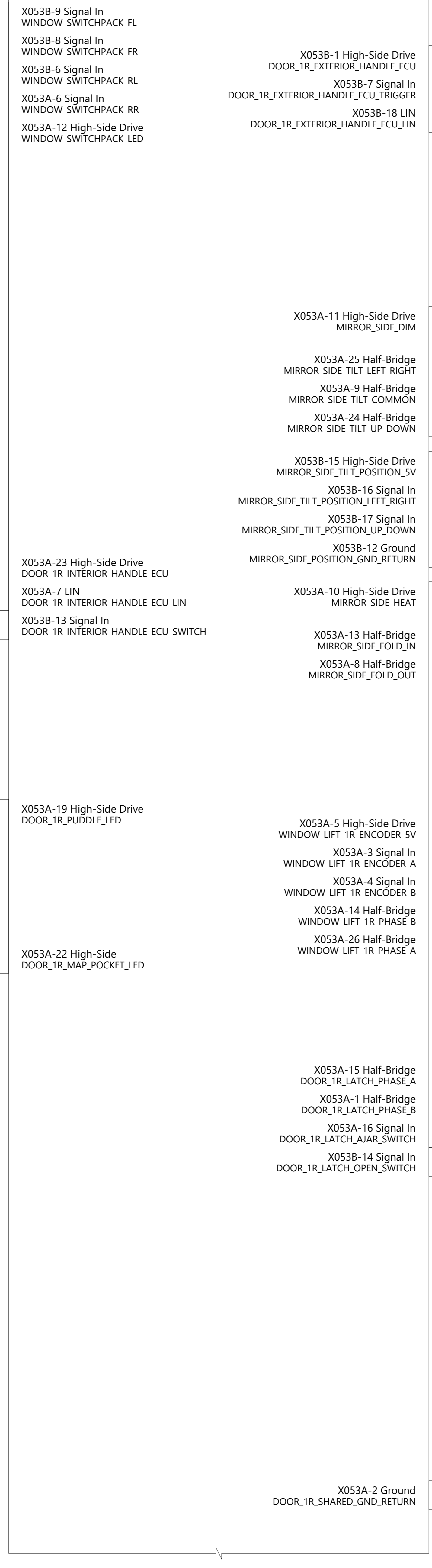

**Door Handle Controller FR**  
P X339

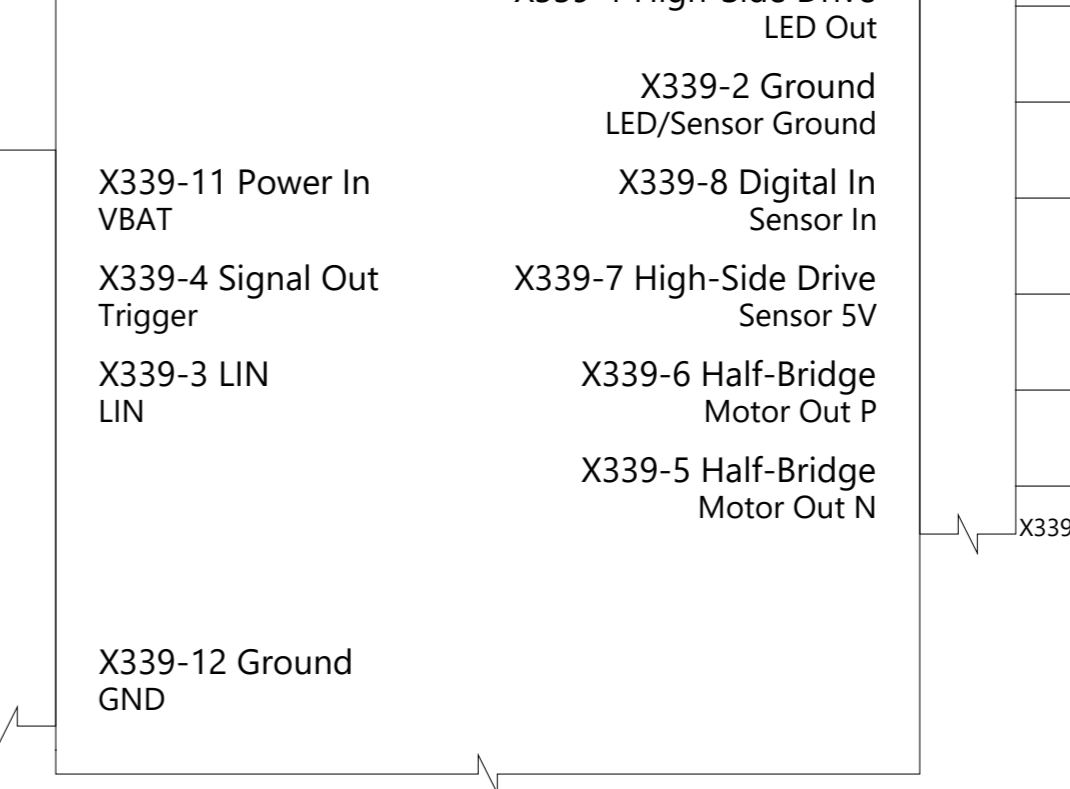

**Door Handle FR**  
P X340A

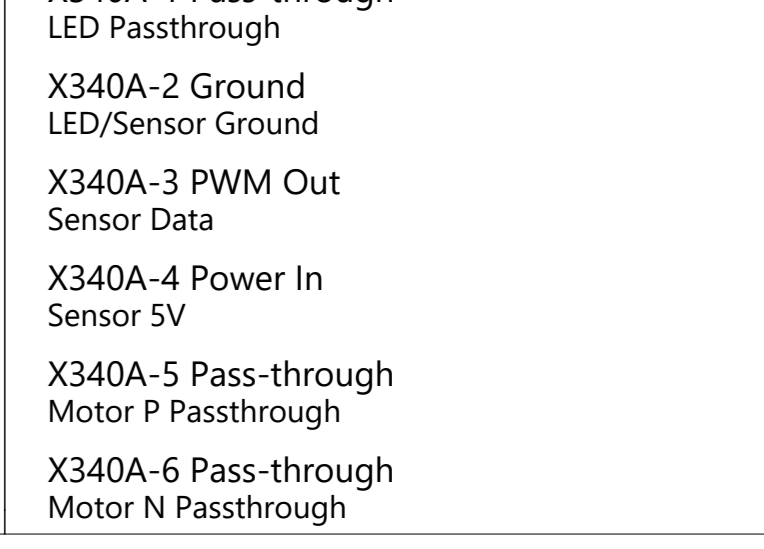

**Mirror Side Right**  
P X346

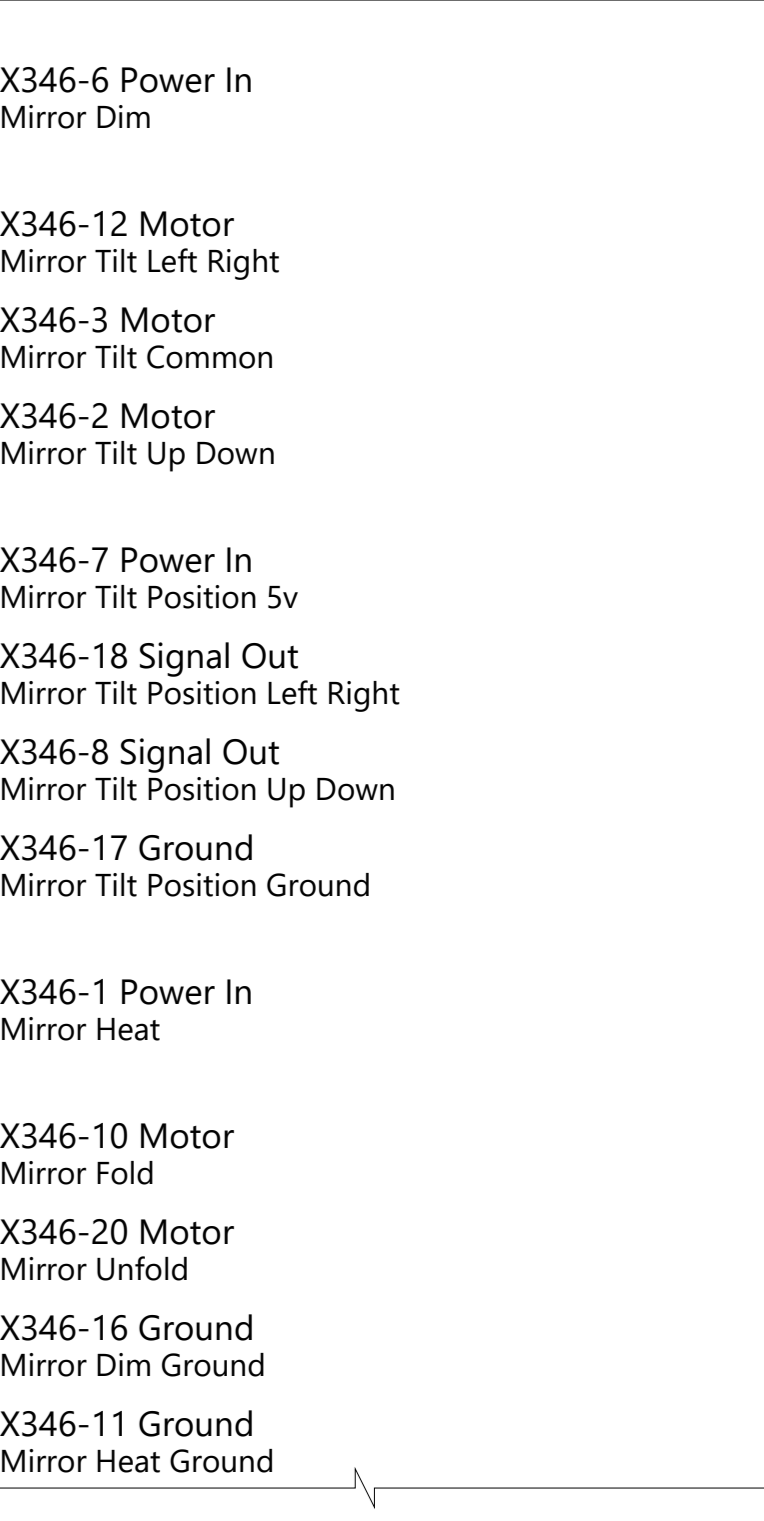

**Window Motor FR**  
P X345

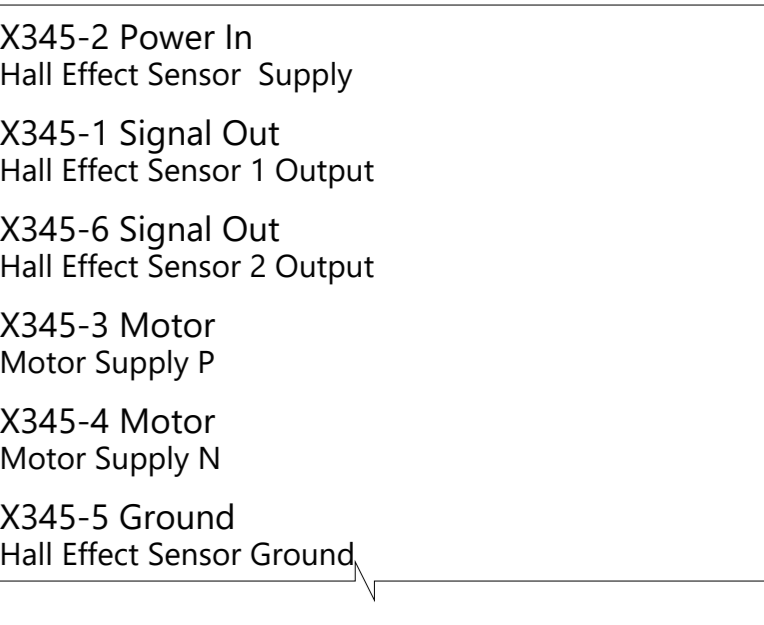

**Door Latch FR**  
P X342

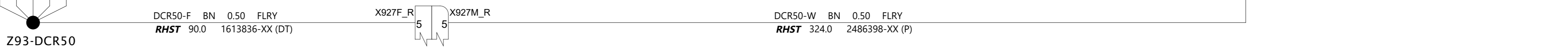
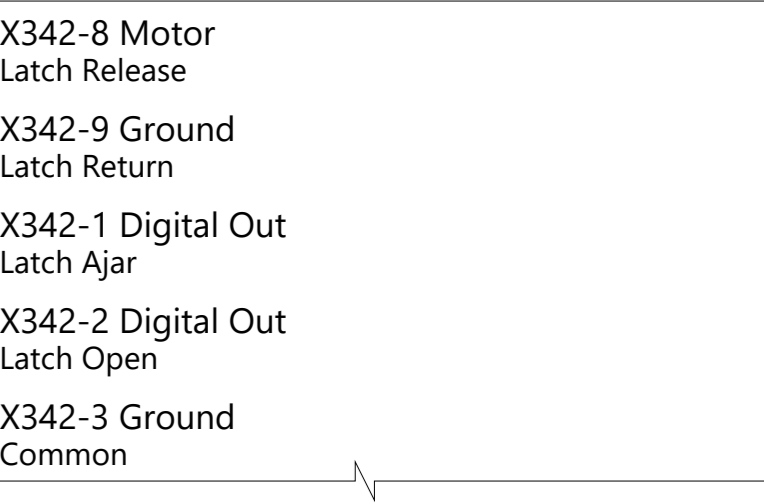

**TESLA**

THE INFORMATION CONTAINED HEREIN IS DEEMED TO BE CONFIDENTIAL, PROPRIETARY, AND A TRADE SECRET OF TESLA MOTORS. THIS INFORMATION MAY NOT BE USED, REPRODUCED, OR DISCLOSED AS THE DIRECT OR INDIRECT BASIS FOR THE DEVELOPMENT, MANUFACTURE, OR SALE OF PROCESSES OR PRODUCTS WITHOUT THE EXPRESSED WRITTEN CONSENT OF TESLA MOTORS.

DRAWN	CHECKED	APPROVED
MATERIAL AS SPECIFIED	FINISHING AS SPECIFIED	SCALE NONE
PART NAME Door Front Right		
PART NUMBER	REV 1	SHEET 19 OF 61
		SIZE A0

Body Controller Left  
A,W,J,D X031 X032 X034 X038A/B X039 X037 X033A/B X035 X036

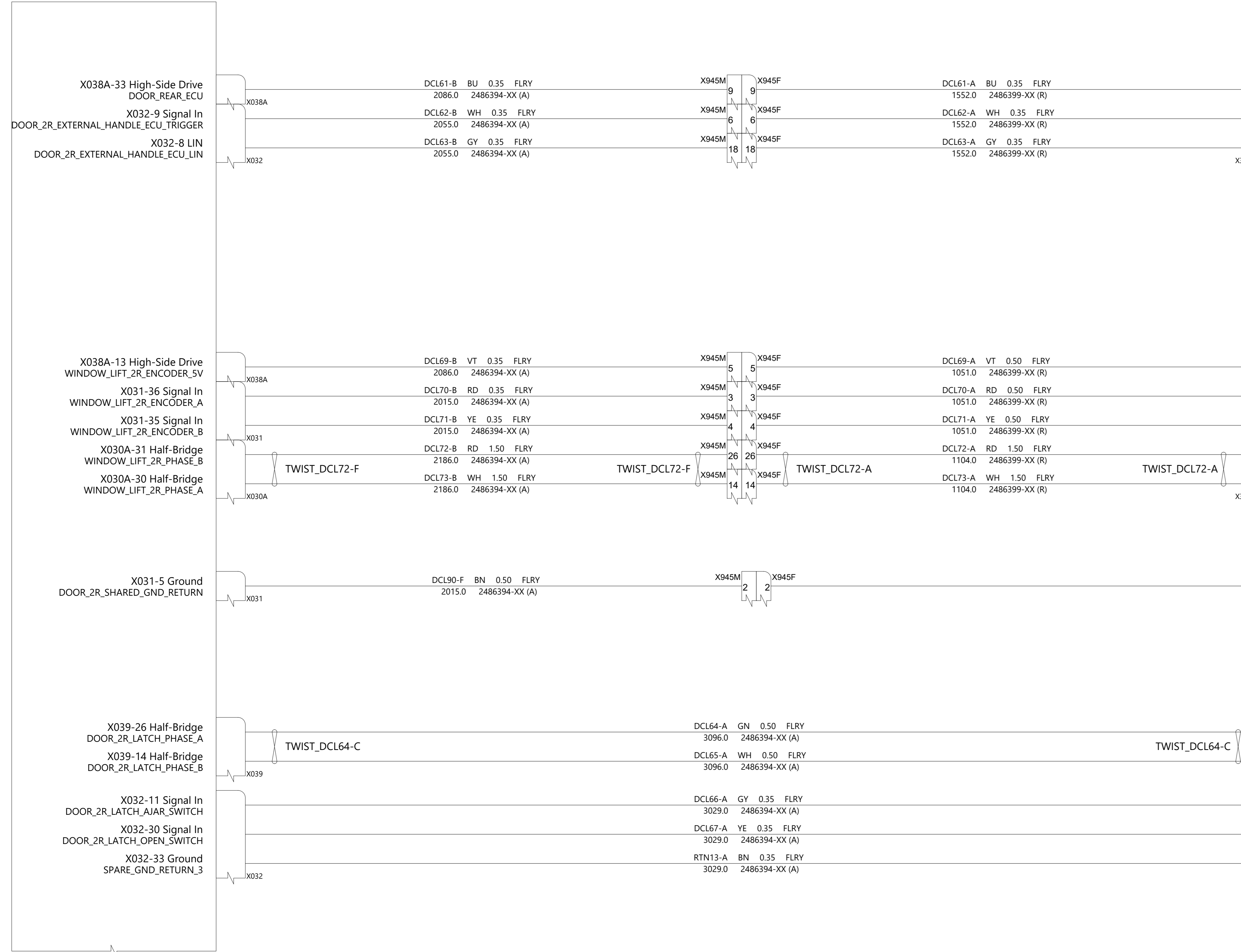

Door Handle Controller RL  
R X359

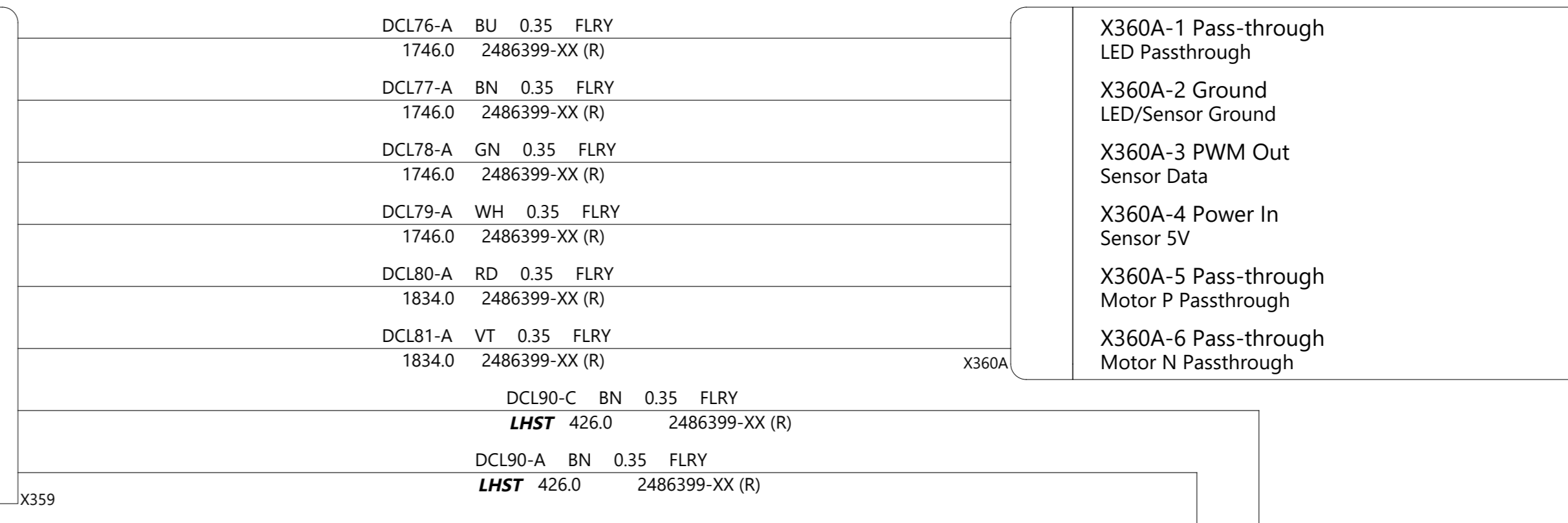
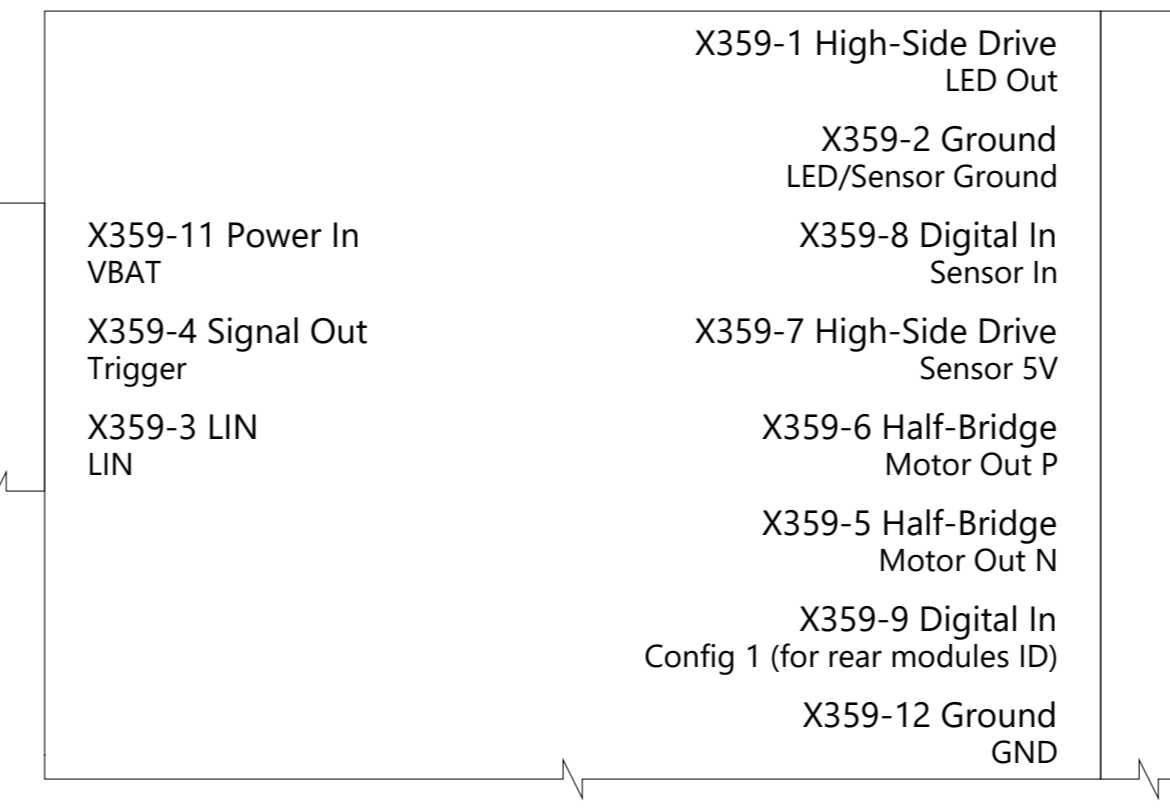

Window Motor RL  
R X366

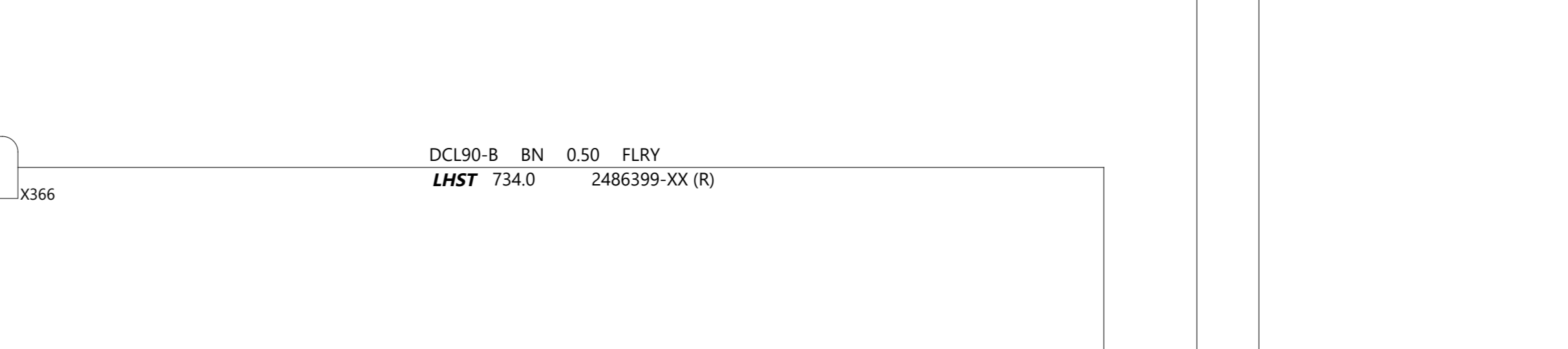
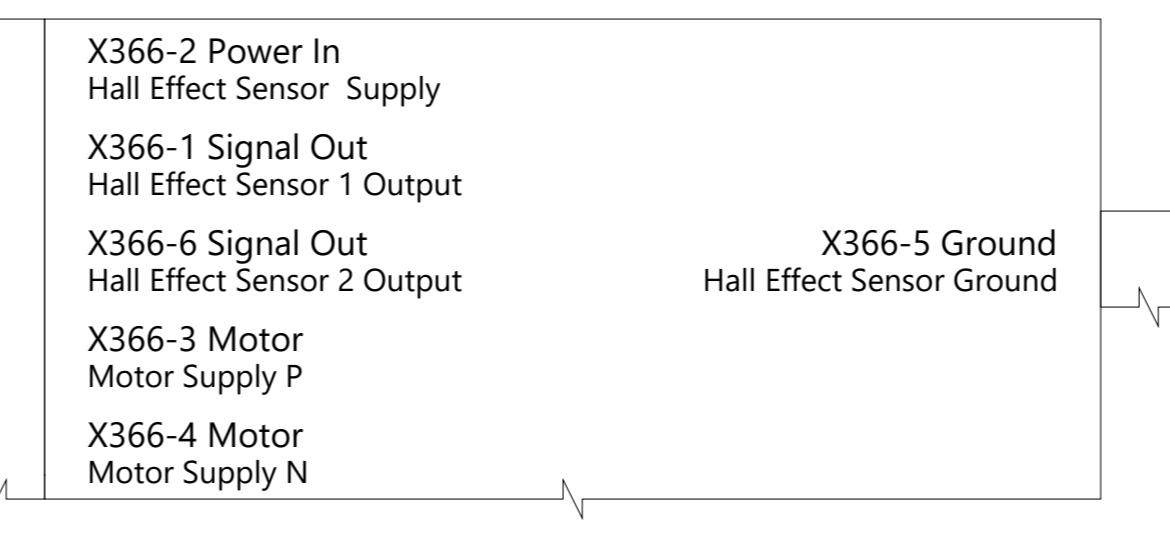

Door Latch RL  
A X362

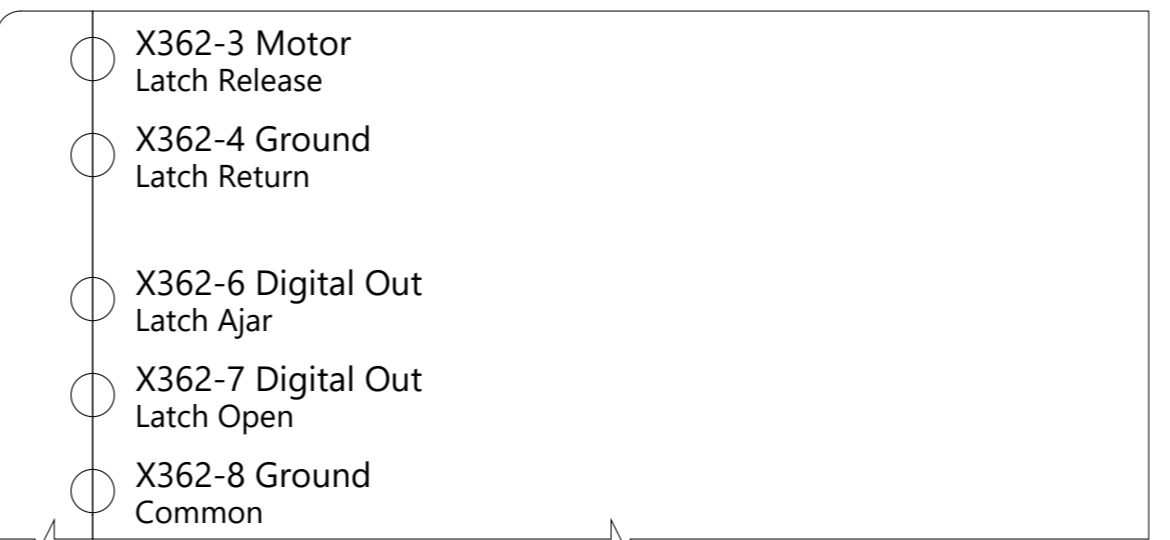

Body Controller Right  
B,W,J,D X051 X052 X054 X060A/B X062 X053A/B X055 X056 X058 X059

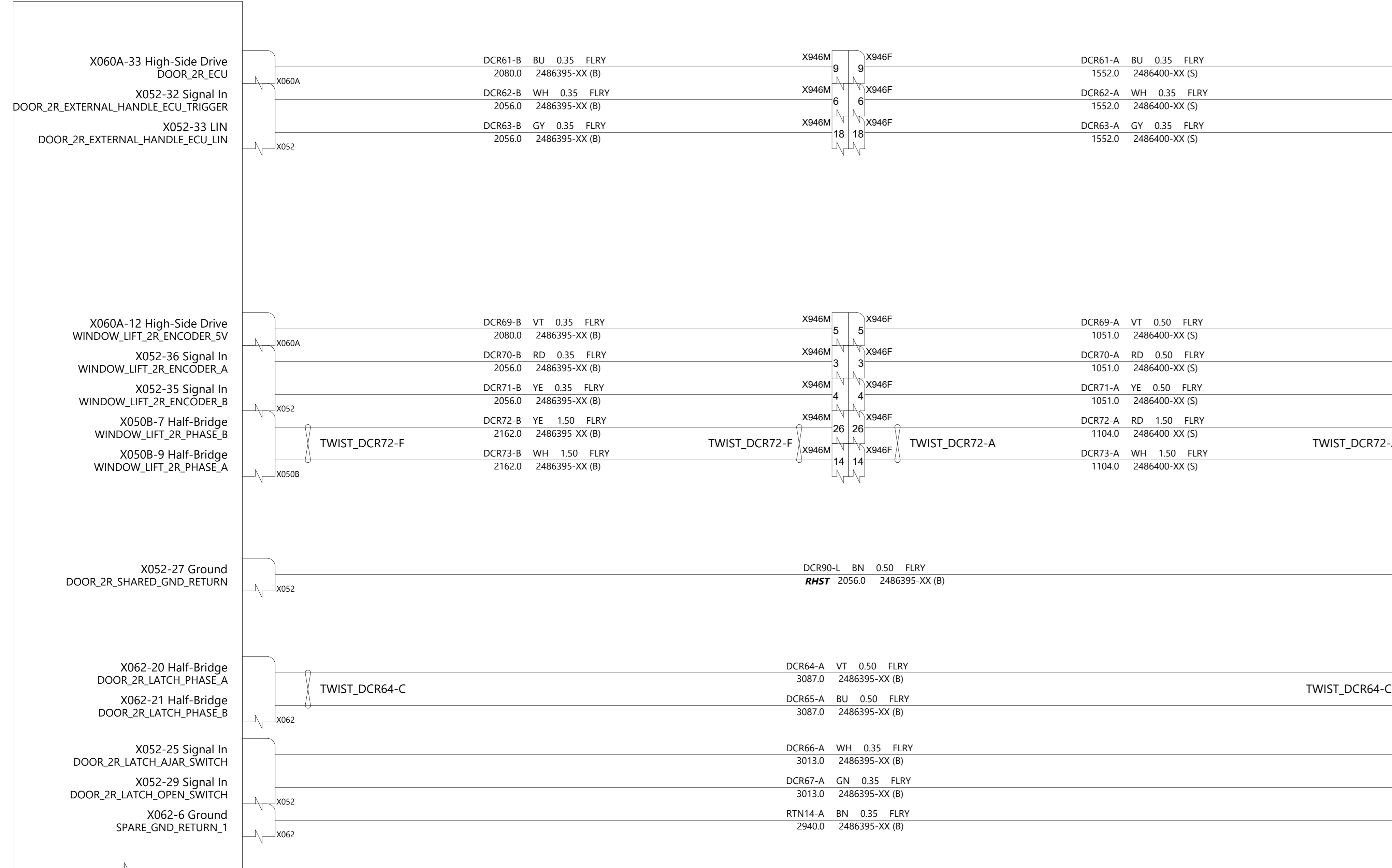

Door Handle Controller RR  
S X369

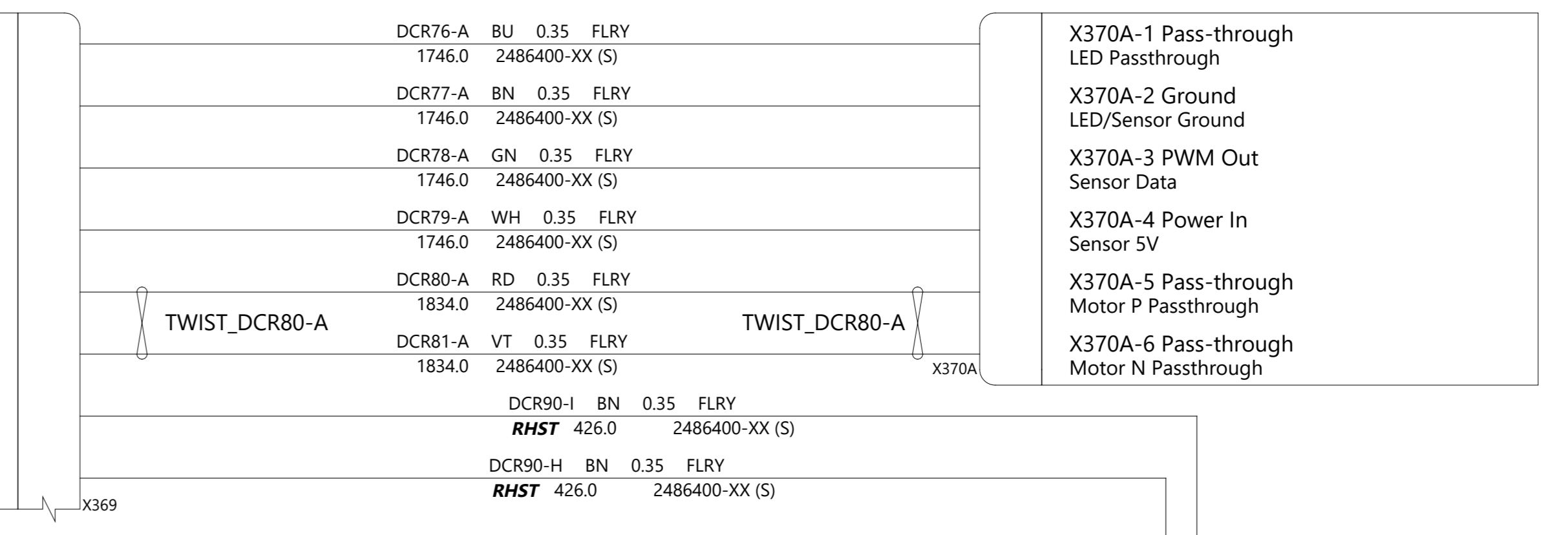
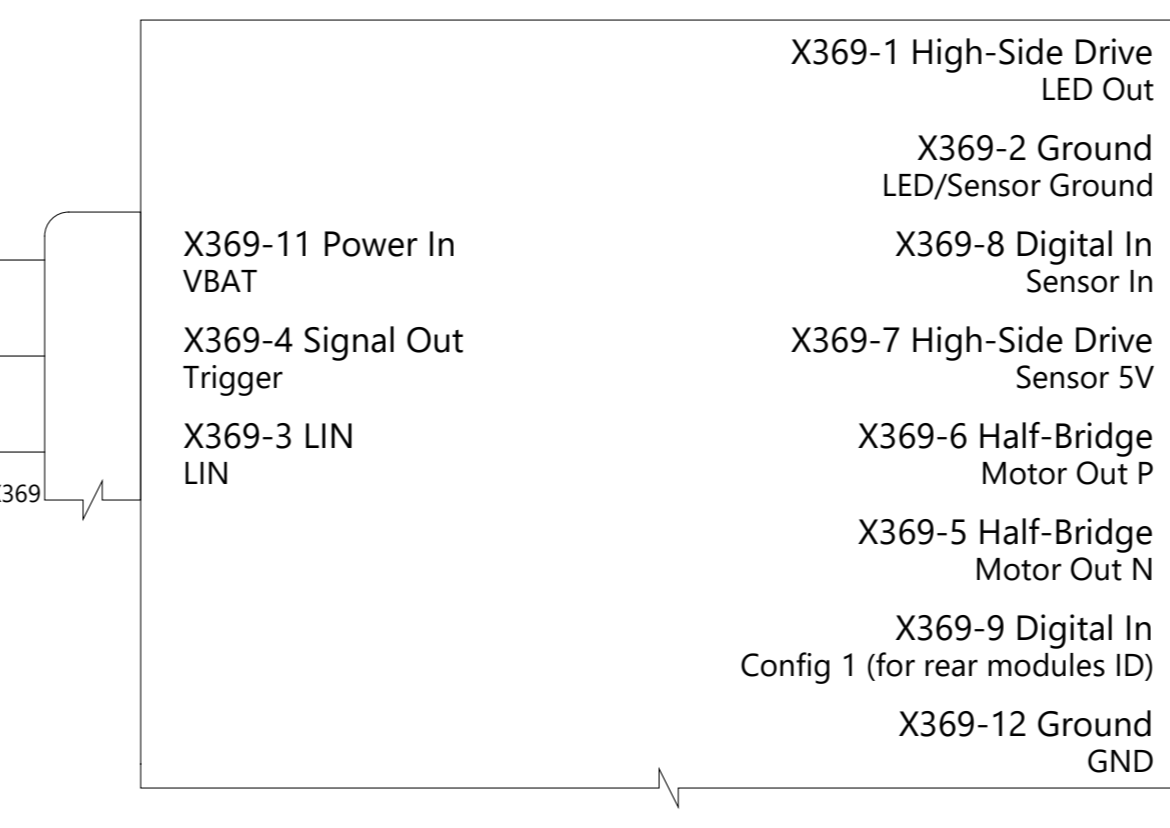

Window Motor RR  
S X377

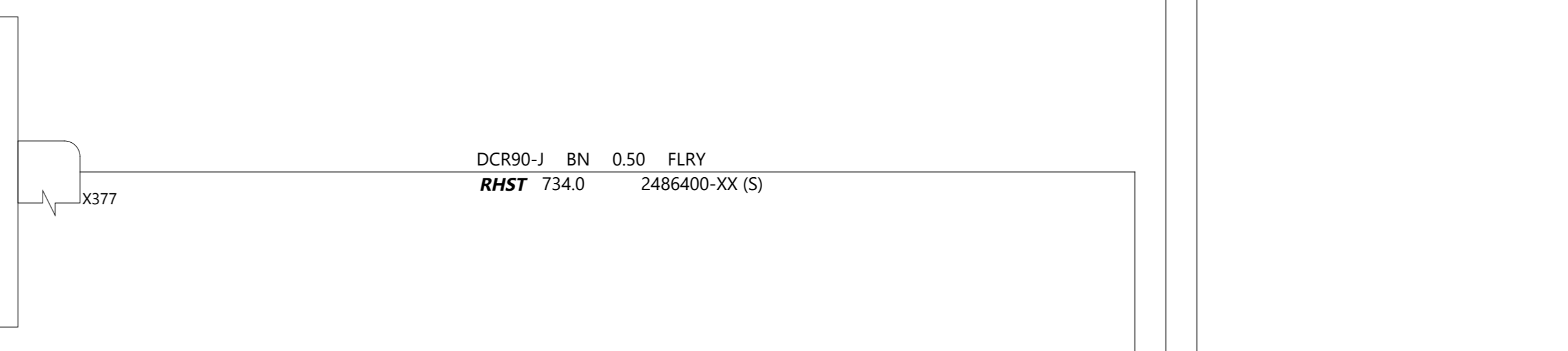
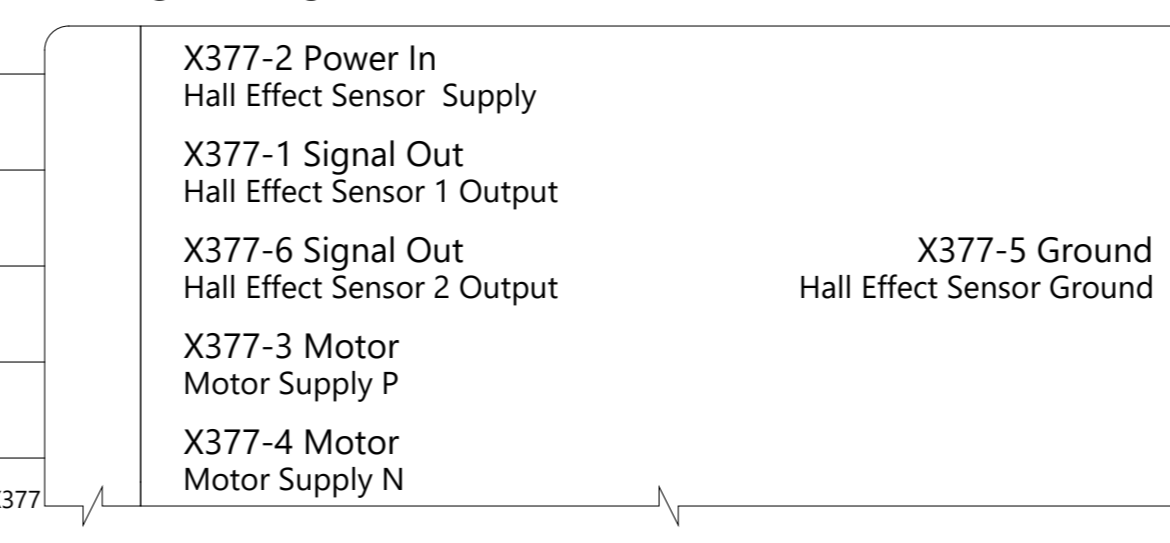

Door Latch RR  
B X372

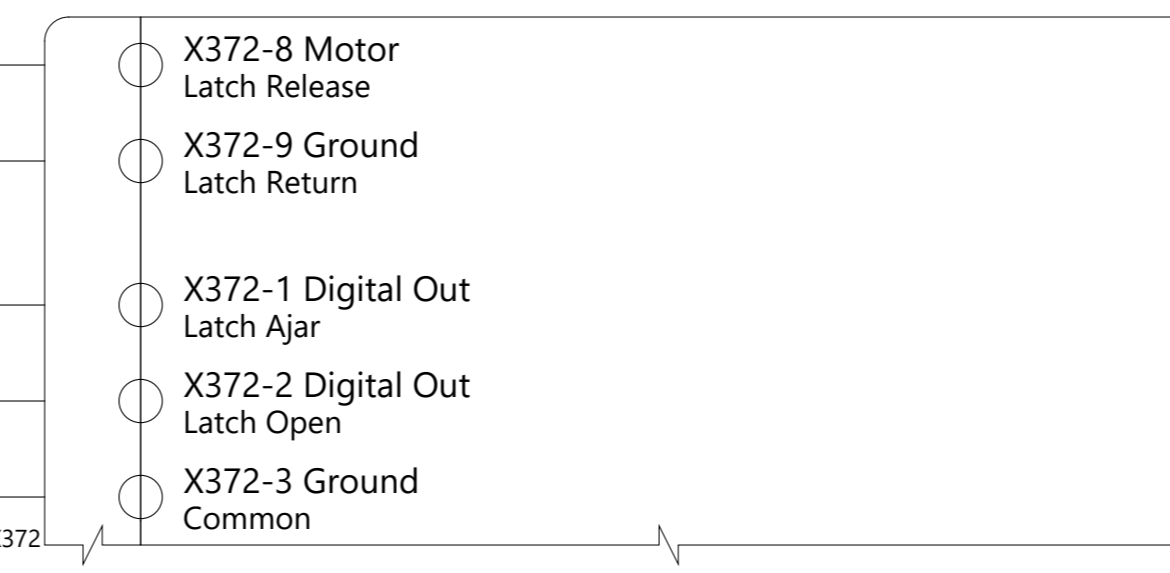

THE INFORMATION CONTAINED HEREIN IS DEEMED TO BE CONFIDENTIAL, PROPRIETARY, AND A TRADE SECRET OF TESLA MOTORS. THIS INFORMATION MAY NOT BE USED, REPRODUCED, OR DISCLOSED AS THE DIRECT OR INDIRECT BASIS FOR THE DEVELOPMENT, MANUFACTURE, OR SALE OF PROCESSES OR PRODUCTS WITHOUT THE EXPRESSED WRITTEN CONSENT OF TESLA MOTORS.

DRAWN	CHECKED	APPROVED
MATERIAL AS SPECIFIED	FINISHING AS SPECIFIED	SCALE NONE
PART NAME Doors Rear 1/2: Handle, Window, Latch		
PART NUMBER	REV 1	SHEET 20 OF 61
		SIZE A0

# Shared door trim harness between Rear Left & Rear Right doors

Body Controller Left  
A,W,J,D

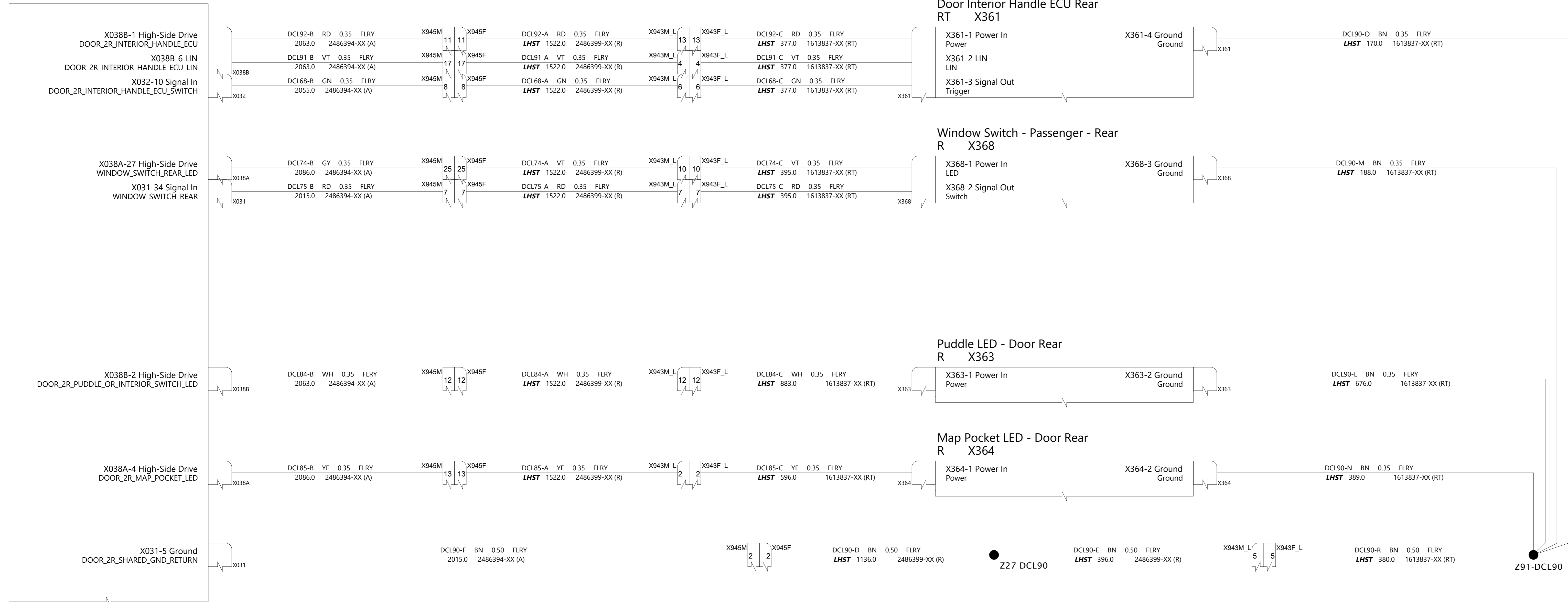

Body Controller Right  
B,W,J,D

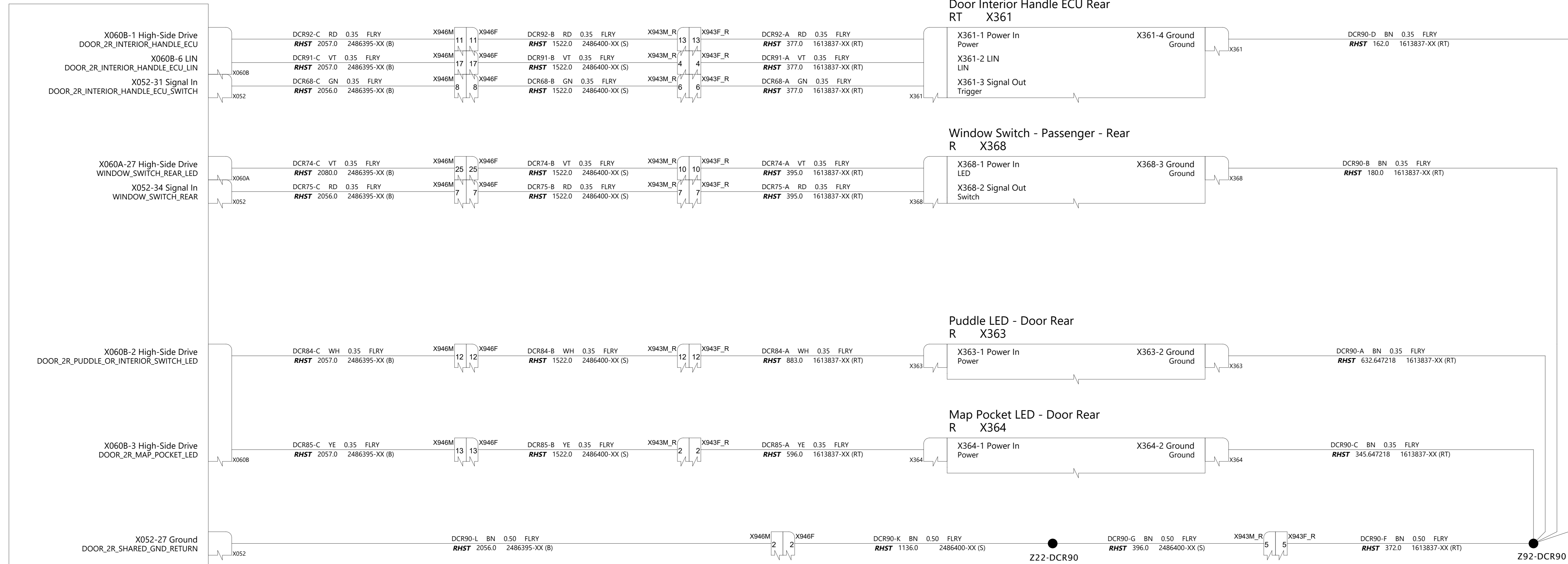

**TESLA**

THE INFORMATION CONTAINED HEREIN IS DEEMED TO BE CONFIDENTIAL, PROPRIETARY, AND A TRADE SECRET OF TESLA MOTORS. THIS INFORMATION MAY NOT BE USED, REPRODUCED, OR DISCLOSED AS THE DIRECT OR INDIRECT BASIS FOR THE DEVELOPMENT, MANUFACTURE, OR SALE OF PROCESSES OR PRODUCTS WITHOUT THE EXPRESSED WRITTEN CONSENT OF TESLA MOTORS.

DRAWN	CHECKED	APPROVED
MATERIAL AS SPECIFIED	FINISHING AS SPECIFIED	SCALE NONE
PART NAME Doors Rear 2/2: Trim		
PART NUMBER	REV	SHEET
	1	23 of 64
		SIZE A0

Body Controller Front  
U, W X021 X010 X011 X012 X013 X014

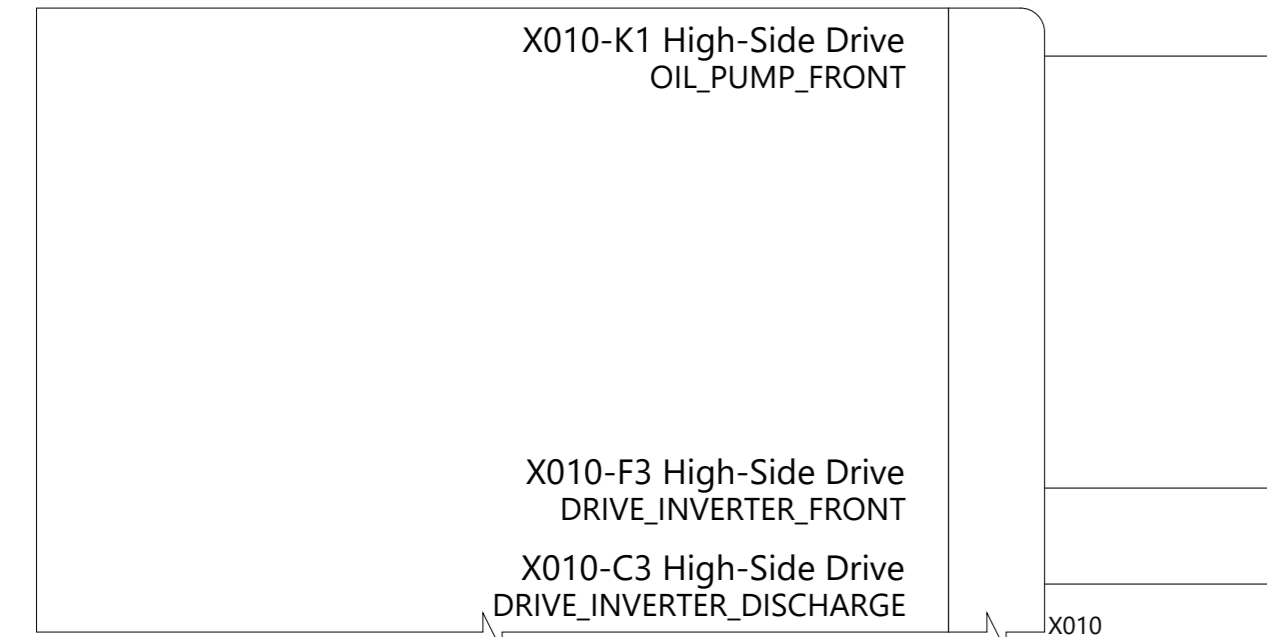

Body Controller Left  
A, W, J, D X031 X032 X034 X038A/B X039 X037 X033A/B X035 X036

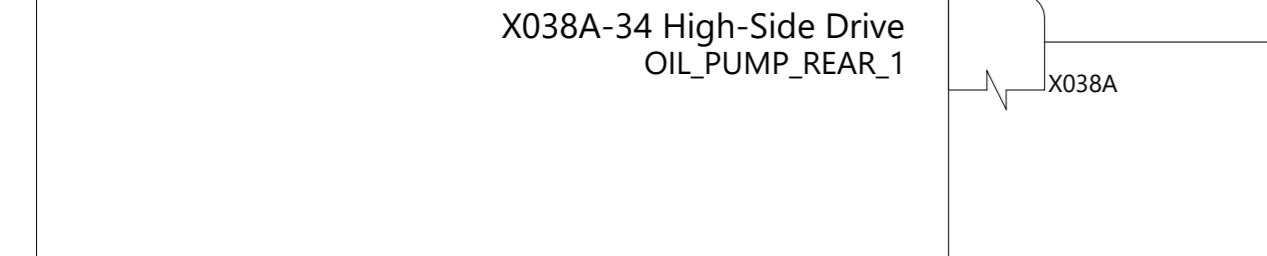
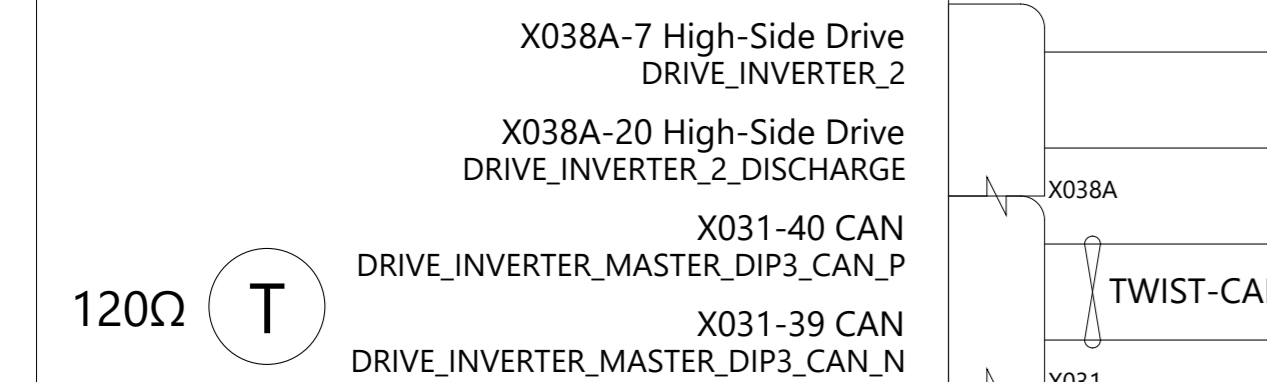
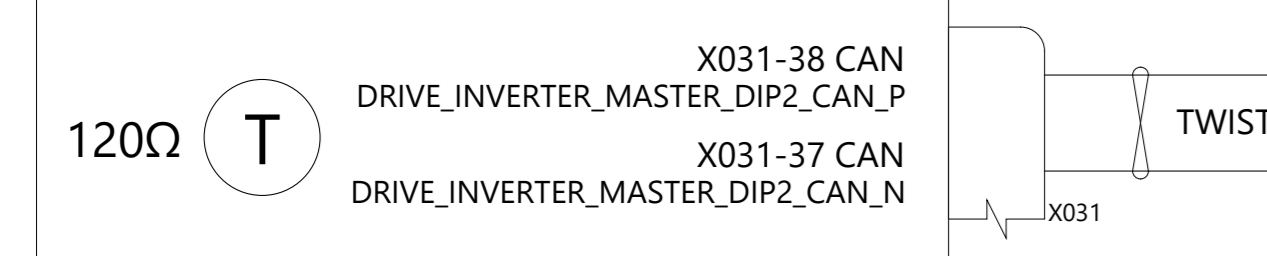
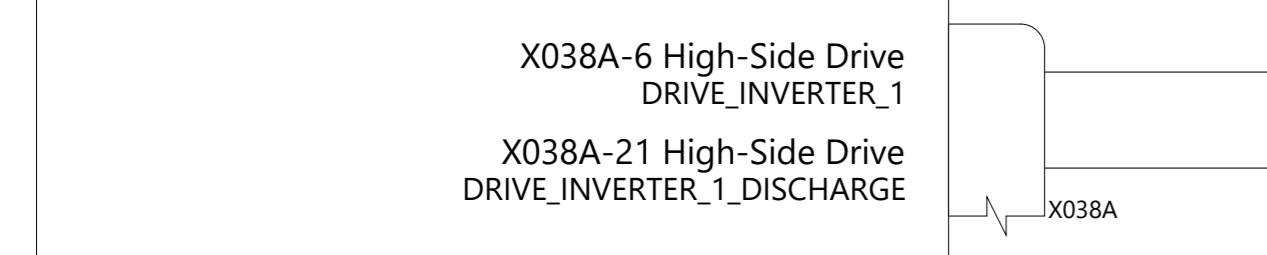
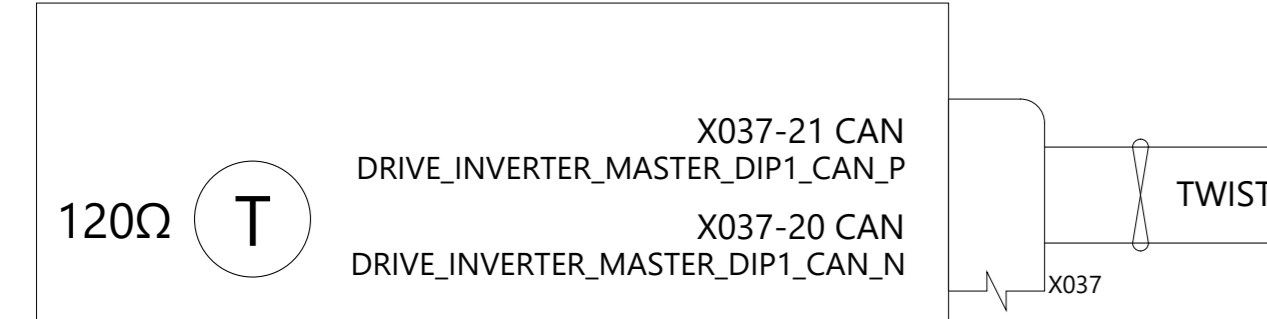

Body Controller Right  
B, W, J, D X051 X052 X054 X060A/B X062 X053A/B X055 X056 X058 X059

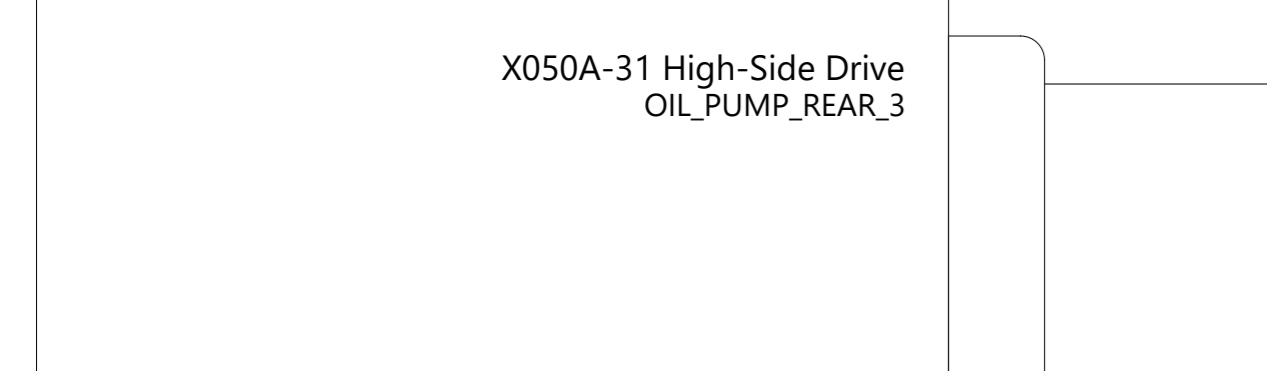

Drive Unit Oil Pump Front  
N X327

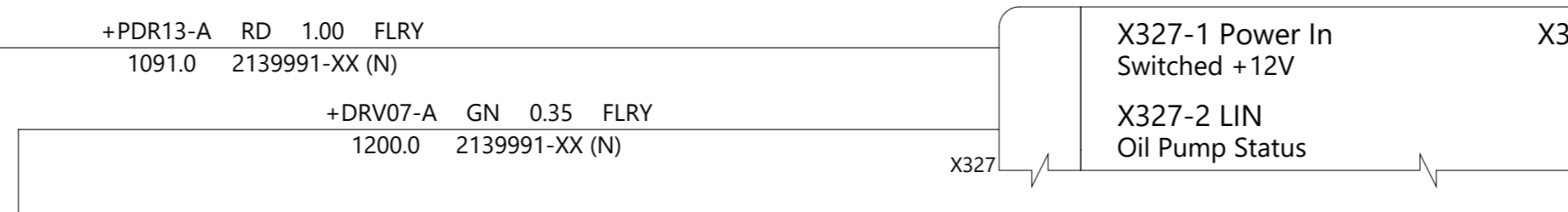

Drive Inverter Front  
N X325

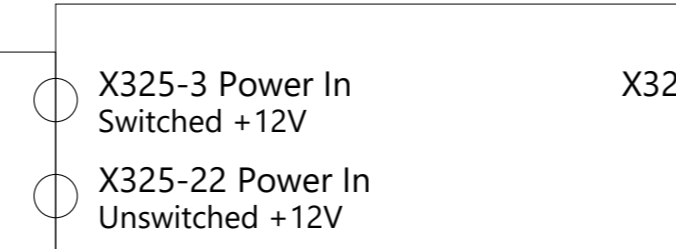

X025  
Drive Inverter Logic Rear  
X X320

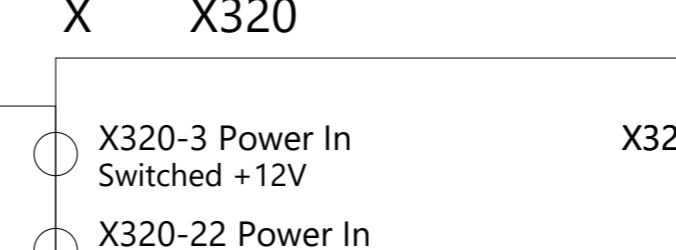

X024  
Drive Inverter Logic RL  
XT X320A

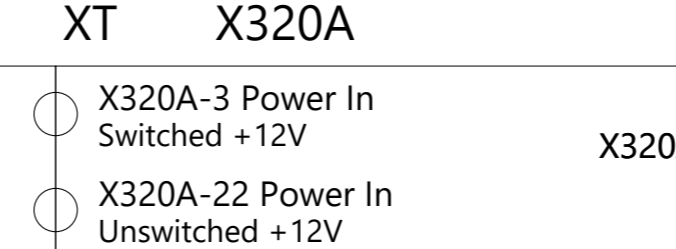

X024  
Drive Inverter Logic RR  
XT X328A

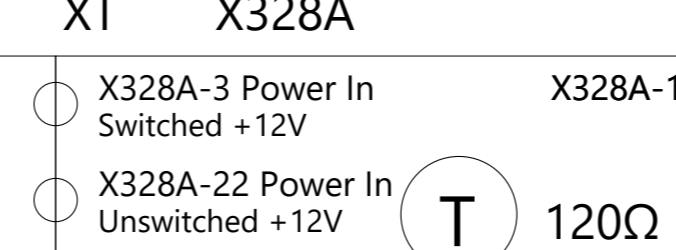

X025  
Drive Unit Oil Pump Rear  
X X322

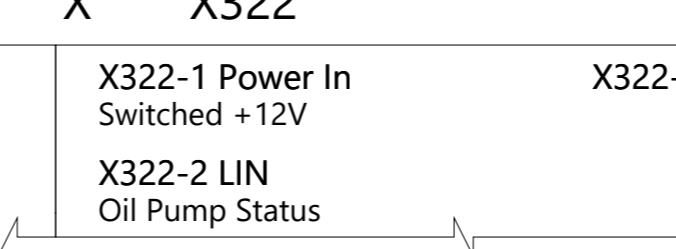

X024  
Drive Unit Oil Pump RR  
XT X322A

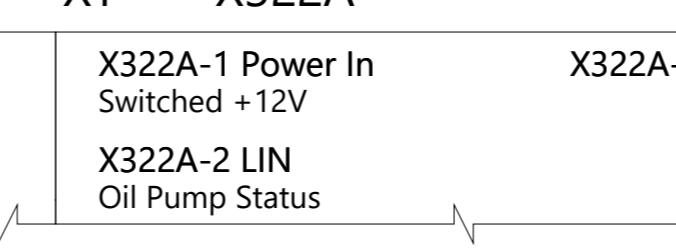

X024  
Drive Unit Oil Pump RL  
X X318A

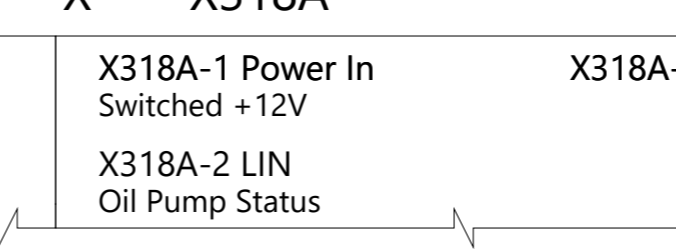

X024  
Drive Unit Oil Pump - Gear Case  
X X319A

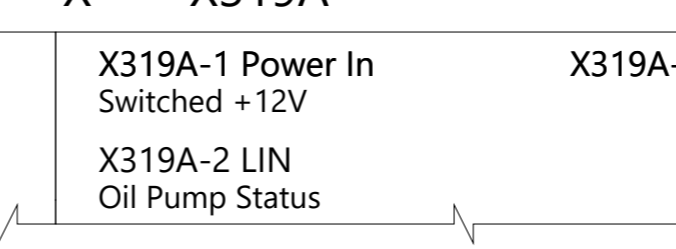

THE INFORMATION CONTAINED HEREIN IS DEEMED TO BE CONFIDENTIAL, PROPRIETARY, AND A TRADE SECRET OF TESLA MOTORS. THIS INFORMATION MAY NOT BE USED, REPRODUCED, OR DISCLOSED AS THE DIRECT OR INDIRECT BASIS FOR THE DEVELOPMENT, MANUFACTURE, OR SALE OF PROCESSES OR PRODUCTS WITHOUT THE EXPRESSED WRITTEN CONSENT OF TESLA MOTORS.

DRAWN	CHECKED	APPROVED
MATERIAL AS SPECIFIED	FINISHING AS SPECIFIED	SCALE NONE
PART NAME Drive Inverter 1/2 - Power & Comms		
PART NUMBER	REV	SHEET
	1	22 of 61
		SIZE A0

**Body Controller Left  
A,W,J,D**

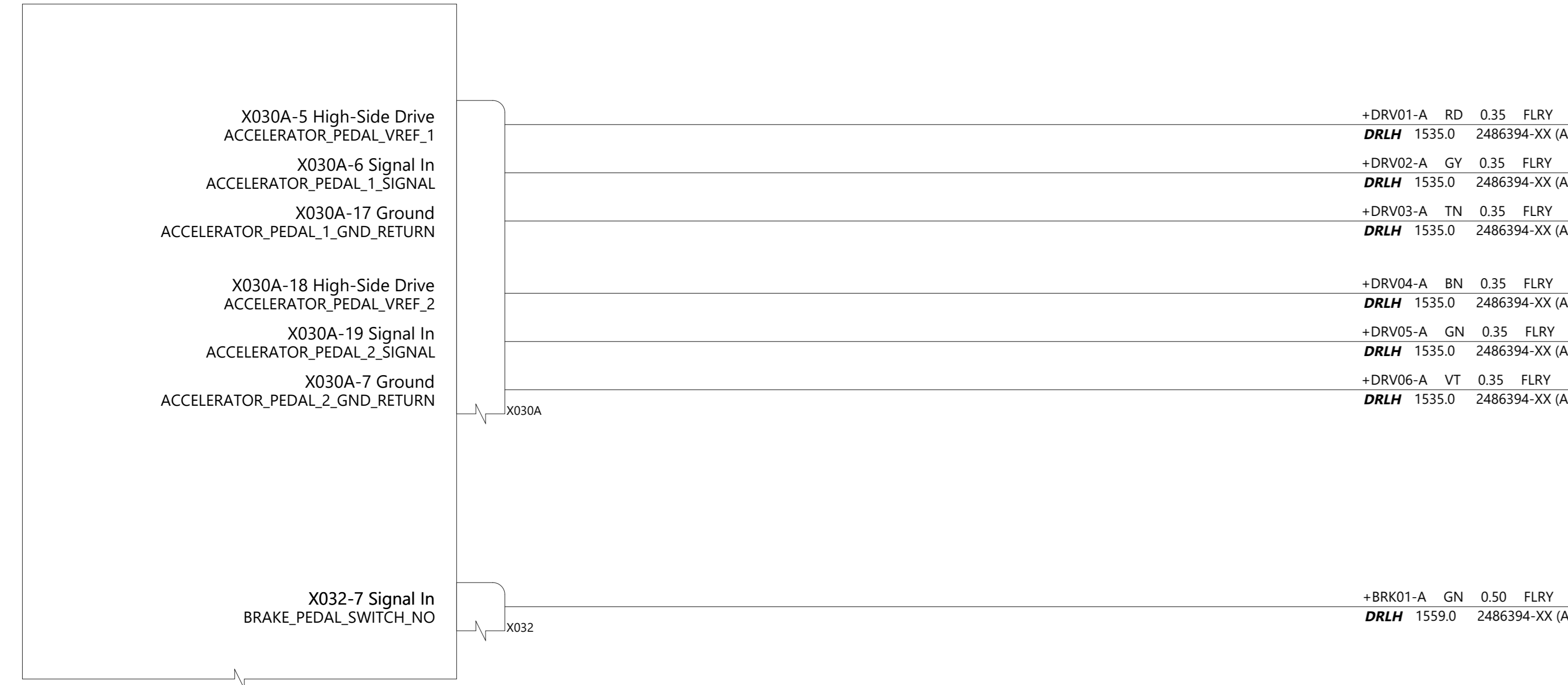

**DRLH || DRRH  
Accelerator Pedal  
A X252**

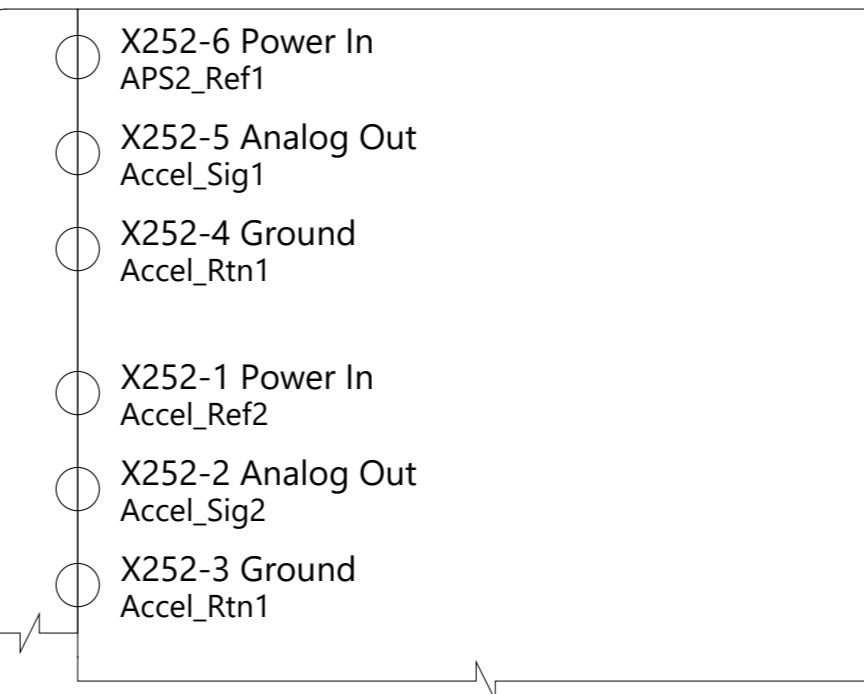

**DRLH || DRRH  
Brake Switch  
A X107**

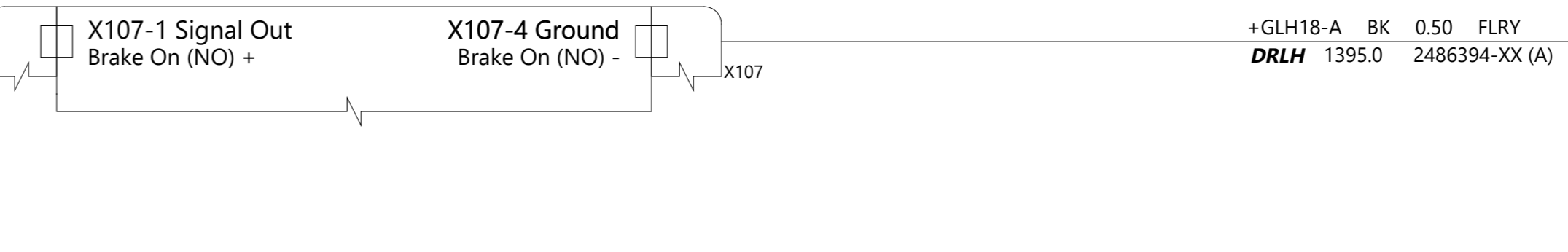

**Drive Inverter Front  
N X325**

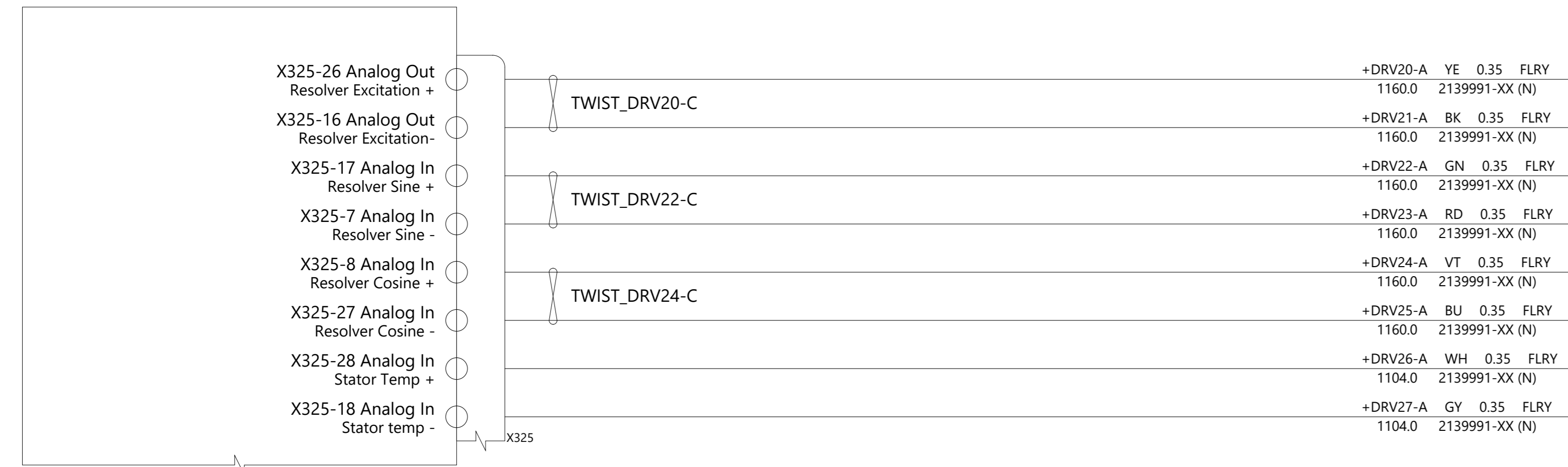

**Driver Inverter Front Resolver  
N X326**

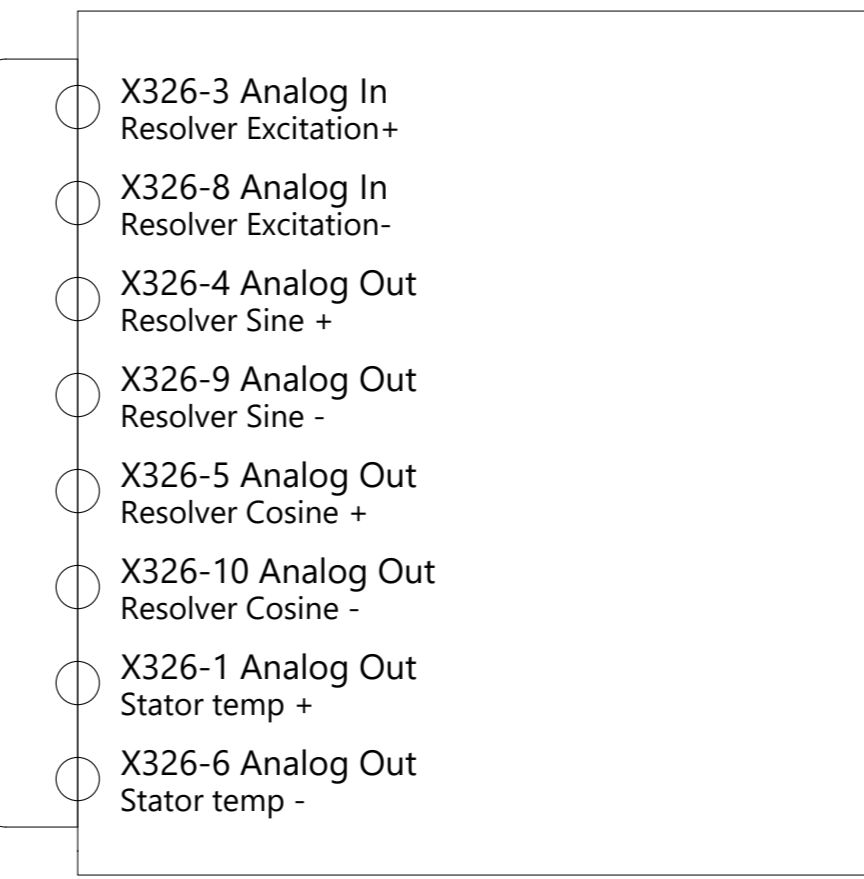

**X025  
Drive Inverter Logic Rear  
X X320**

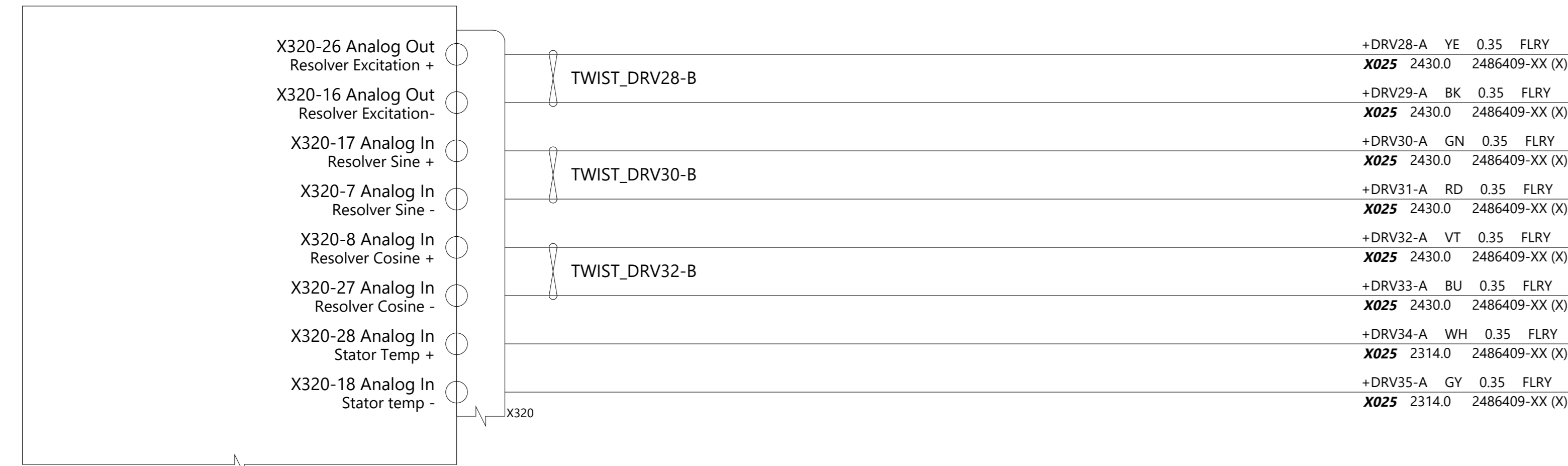

**X025  
Driver Inverter Resolver Rear  
X X321**

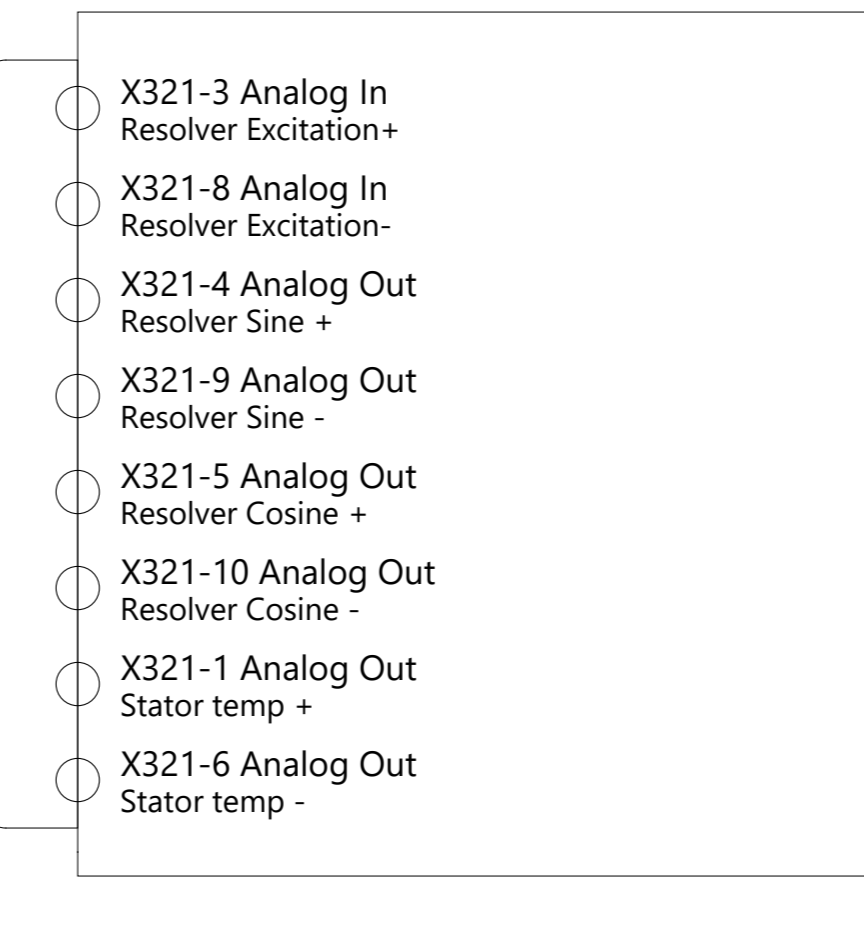

**X024  
Drive Inverter Logic RL  
XT X320A**

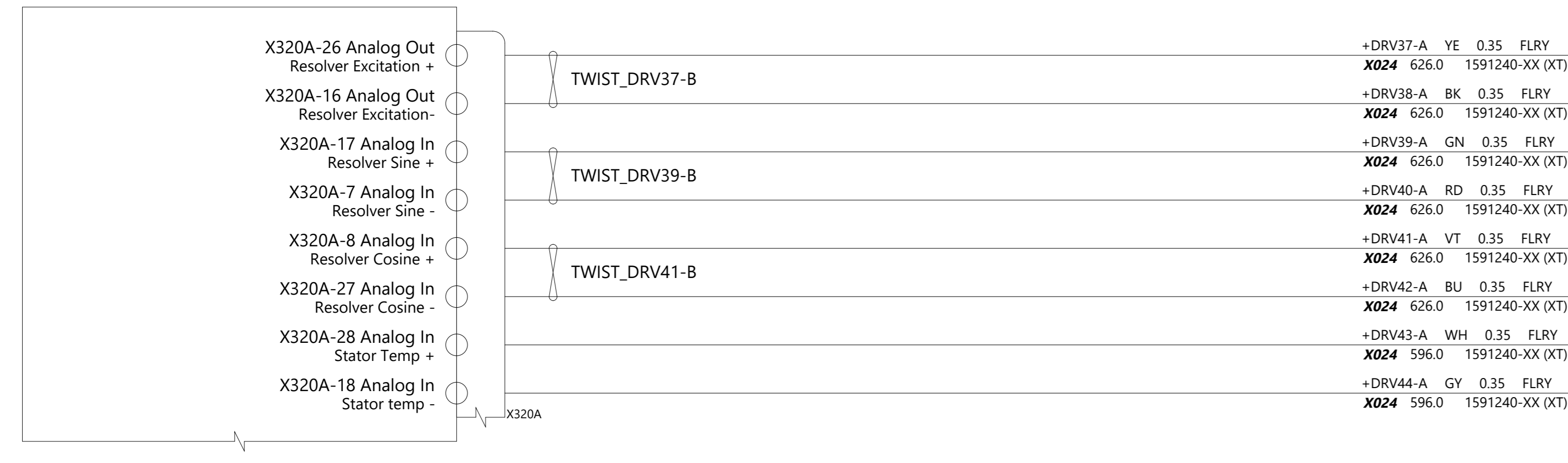

**X024  
Drive Inverter Resolver RL  
X X321A**

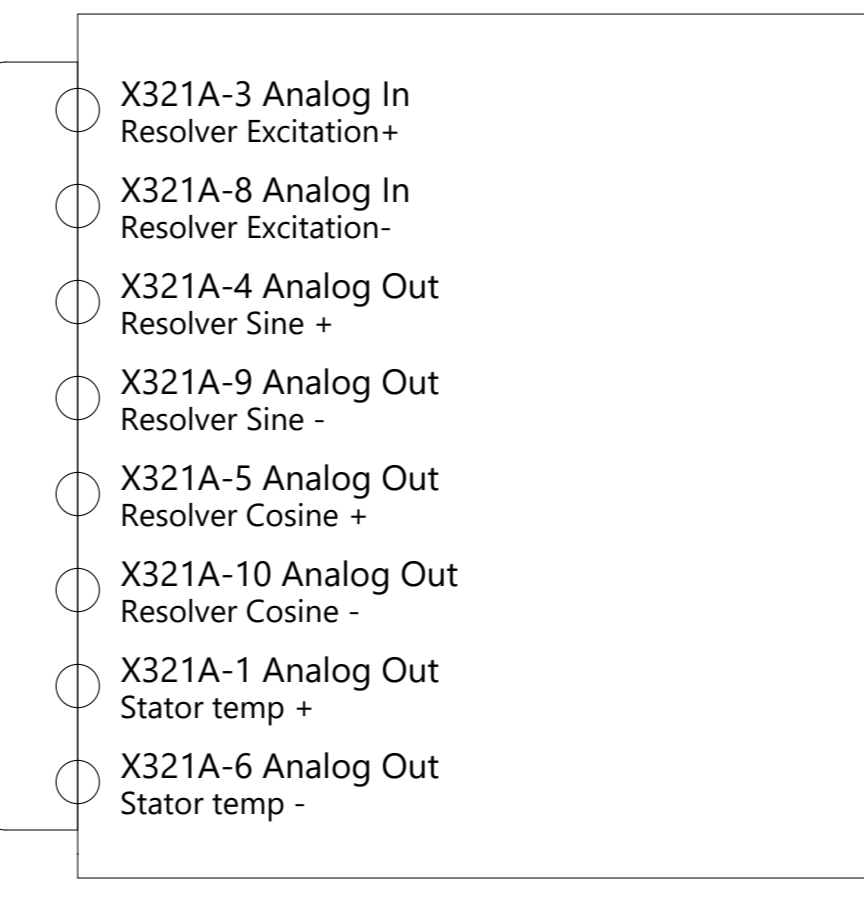

**X024  
Drive Inverter Logic RR  
XT X328A**

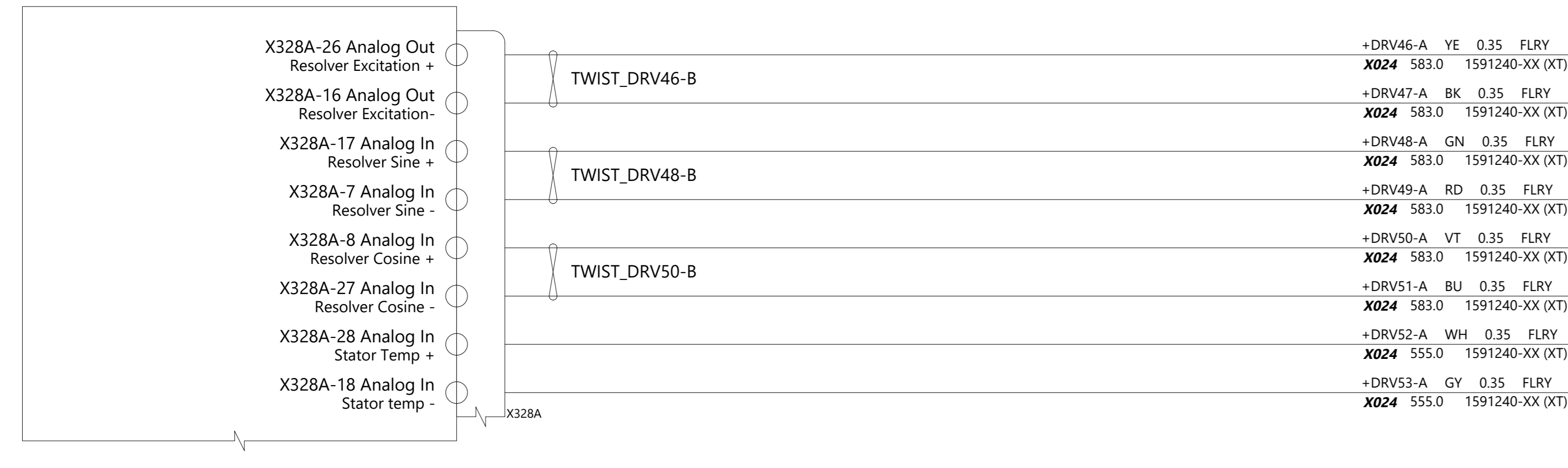

**X024  
Driver Inverter Resolver Rear RR  
XT X329A**

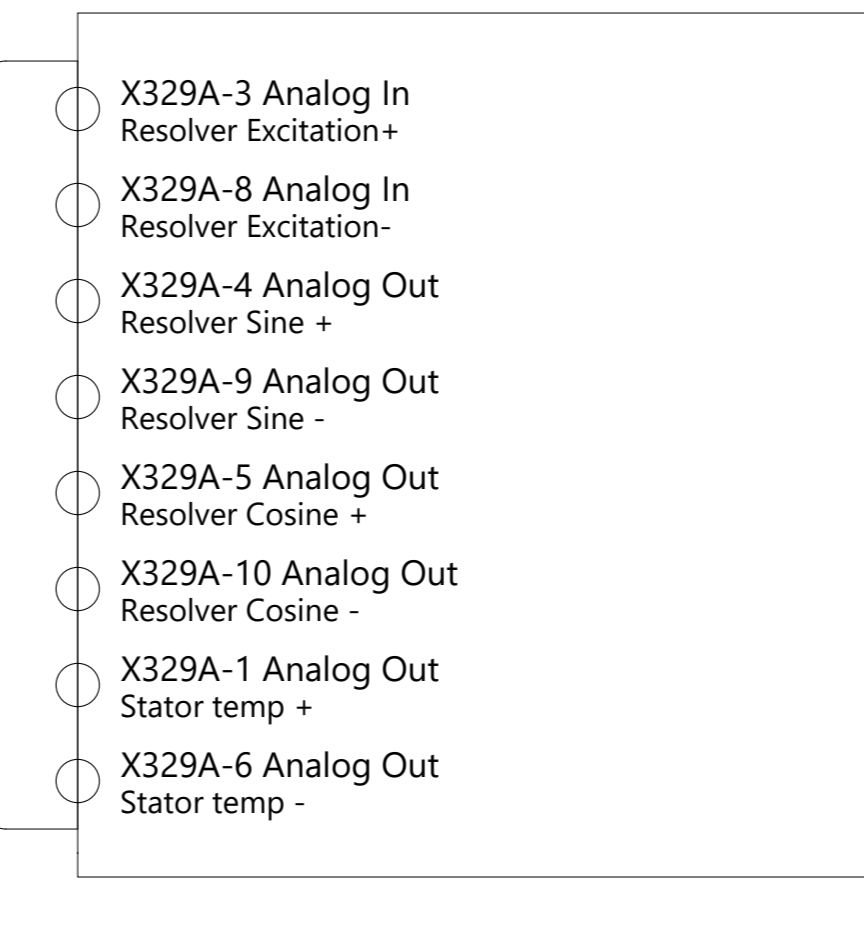

**TESLA**

THE INFORMATION CONTAINED HEREIN IS DEEMED TO BE CONFIDENTIAL, PROPRIETARY, AND A TRADE SECRET OF TESLA MOTORS. THIS INFORMATION MAY NOT BE USED, REPRODUCED, OR DISCLOSED AS THE DIRECT OR INDIRECT BASIS FOR THE DEVELOPMENT, MANUFACTURE, OR SALE OF PROCESSES OR PRODUCTS WITHOUT THE EXPRESSED WRITTEN CONSENT OF TESLA MOTORS.

DRAWN	CHECKED	APPROVED

MATERIAL AS SPECIFIED	FINISHING AS SPECIFIED	SCALE NONE

PART NAME  
**Drive Inverter 2/2 - Resolvers & Pedals**

PART NUMBER	REV	SHEET	SIZE
	1	23 OF 61	A0

Autopilot  
W,J X149 X865 X835 X836 X866 X838 X839 X833 X837 X150

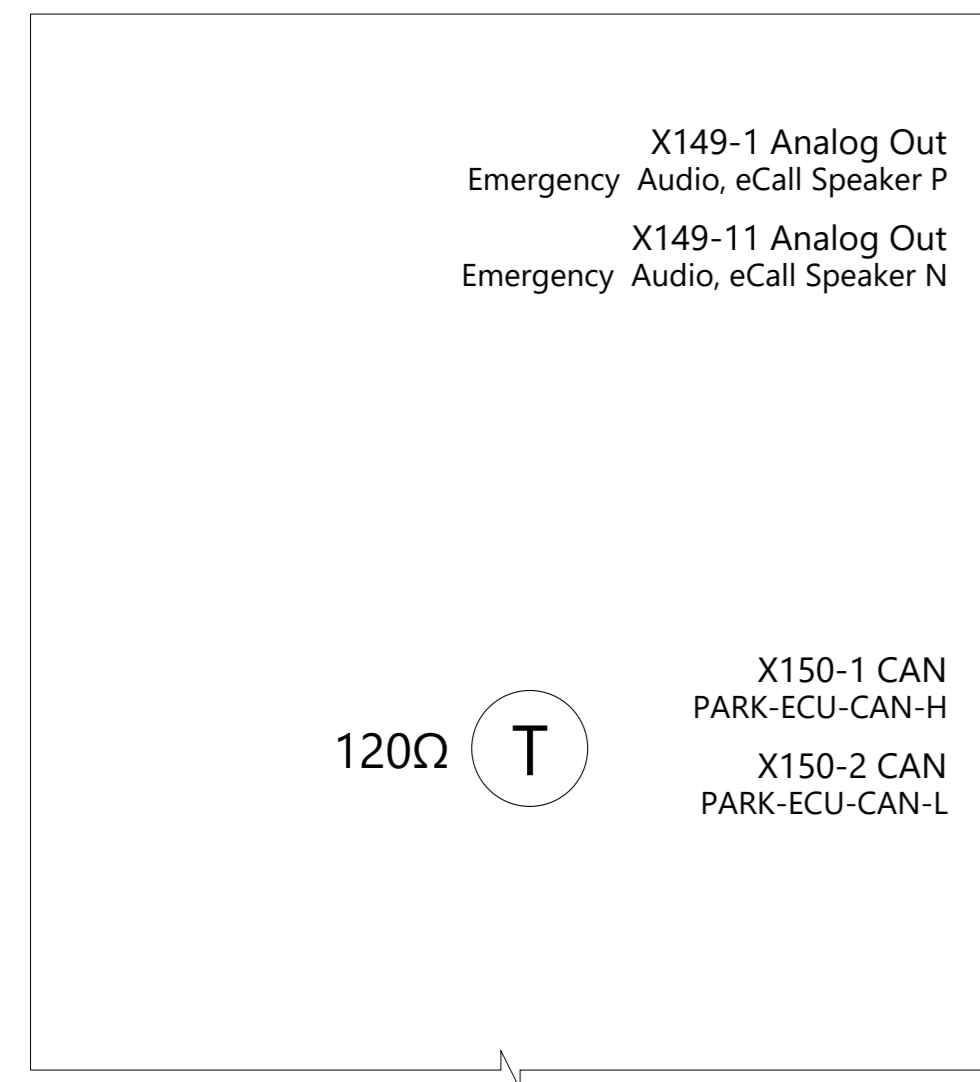

TWIST\_AUD48-E

+AUD48-A VT 0.35 FLY  
**DRLH && -ECALL** 614.0 2486408-XX (W)  
 +AUD49-A GN 0.35 FLY  
**DRLH && -ECALL** 614.0 2486408-XX (W)

TWIST\_AUD48-E

X445

**DRLH**  
 Speaker Emergency Audio  
 W X445



Body Controller Right  
 B,W,J,D X050A/B X051 X052 X054 X060A/B X062 X053A/B X055 X056 X058 X059

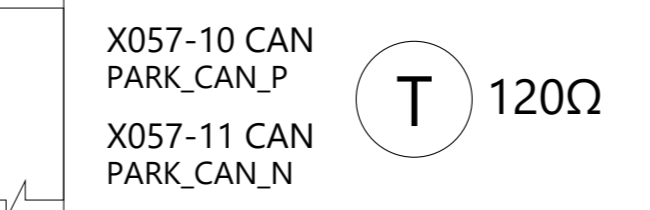

TWIST\_CDA01-D

+CDA01-A VT 0.35 FLY  
 808.0 2486408-XX (W)  
 +CDA02-A RD 0.35 FLY  
 808.0 2486408-XX (W)

TWIST\_CDA01-D

X057

**TESLA**

THE INFORMATION CONTAINED HEREIN IS DEEMED TO BE CONFIDENTIAL, PROPRIETARY, AND A TRADE SECRET OF TESLA MOTORS. THIS INFORMATION MAY NOT BE USED, REPRODUCED, OR DISCLOSED AS THE DIRECT OR INDIRECT BASIS FOR THE DEVELOPMENT, MANUFACTURE, OR SALE OF PROCESSES OR PRODUCTS WITHOUT THE EXPRESSED WRITTEN CONSENT OF TESLA MOTORS.

DRAWN	CHECKED	APPROVED

MATERIAL AS SPECIFIED	FINISHING AS SPECIFIED	SCALE NONE
--------------------------	---------------------------	---------------

PART NAME  
**Driver Assistance**

PART NUMBER	REV	SHEET	SIZE
	1	24 of 61	A0



Body Controller Right  
B,W,J,D X051 X052 X054 X060A/B X062 X053A/B X055 X056 X058 X059

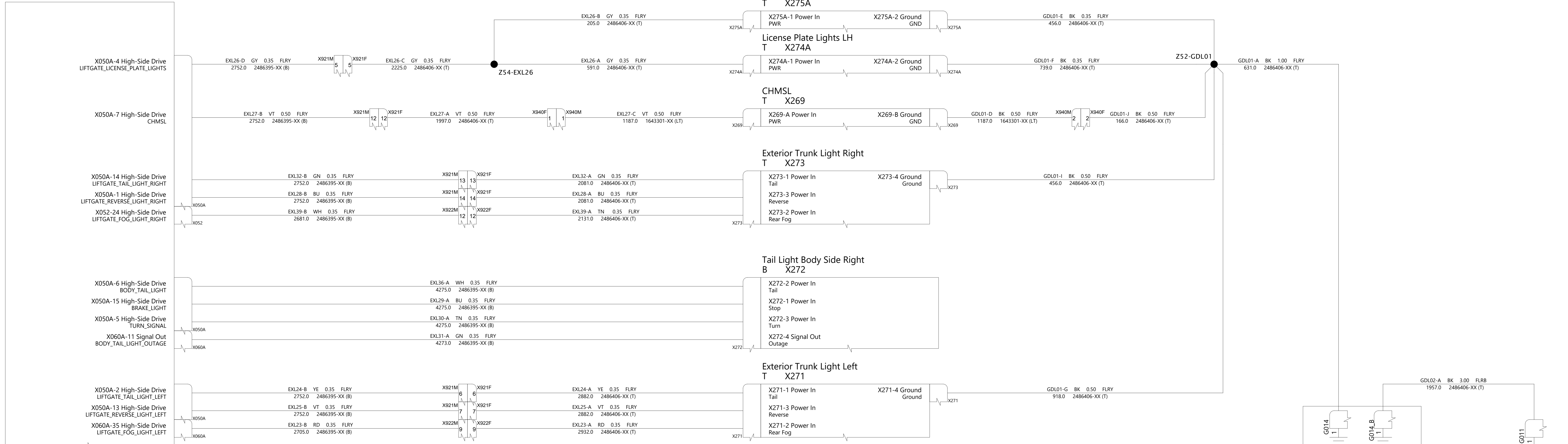

Body Controller Left  
A,W,J,D X031 X032 X034 X038A/B X039 X037 X033A/B X035 X036

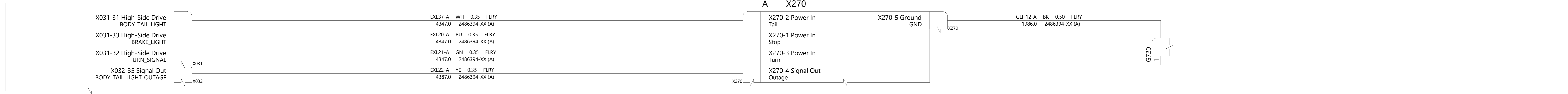

Body Controller Front  
U, W X021 X010 X011 X012 X013 X014

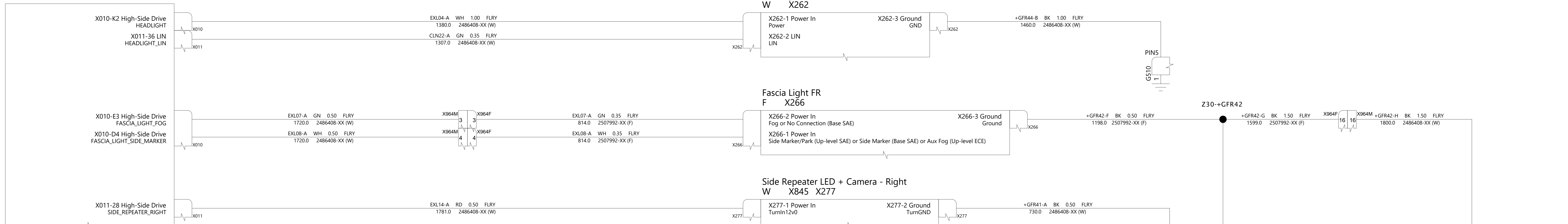

Body Controller Battery  
W X025 X022 X023 X024 X026

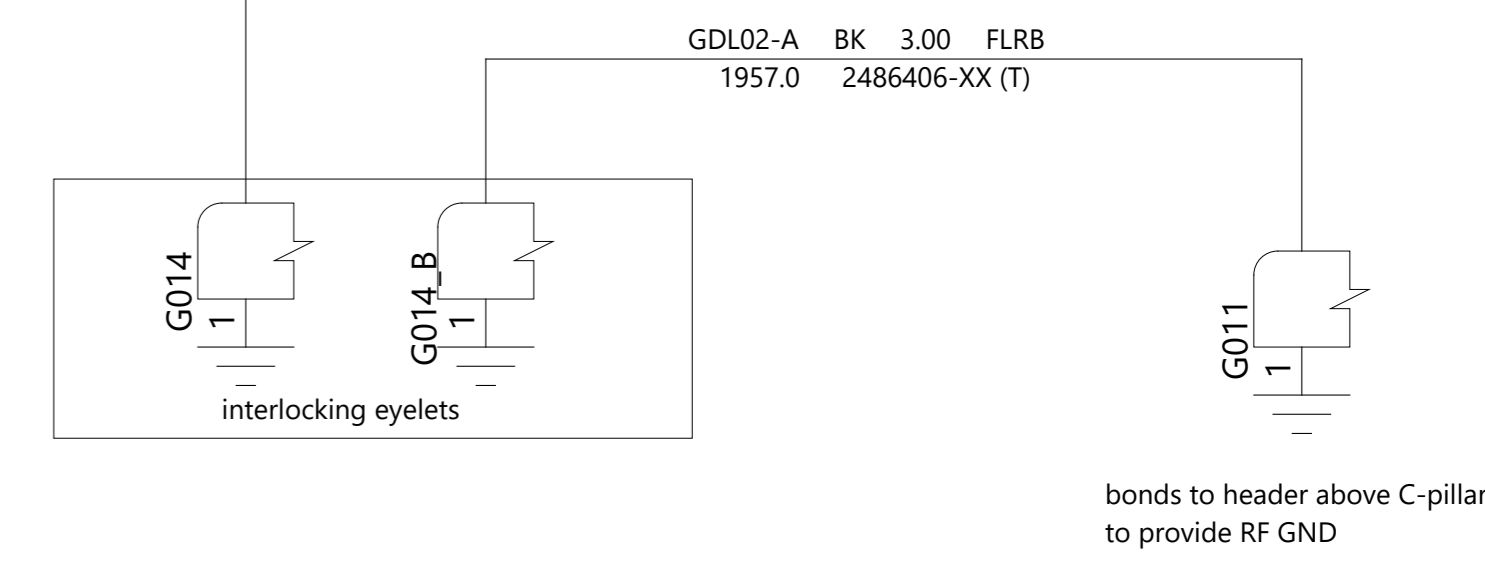
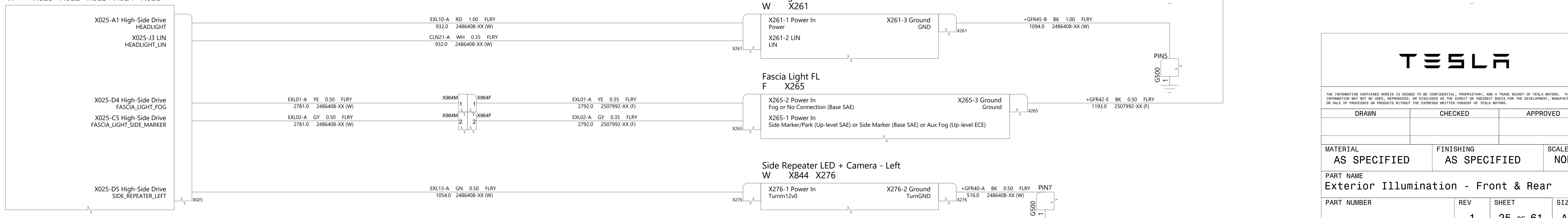

THE INFORMATION CONTAINED HEREIN IS DEEMED TO BE CONFIDENTIAL, PROPRIETARY, AND A TRADE SECRET OF TESLA MOTORS. THIS INFORMATION MAY NOT BE USED, REPRODUCED, OR DISCLOSED AS THE DIRECT OR INDIRECT BASIS FOR THE DEVELOPMENT, MANUFACTURE, OR SALE OF PROCESSES OR PRODUCTS WITHOUT THE EXPRESSED WRITTEN CONSENT OF TESLA MOTORS.

DRAWN	CHECKED	APPROVED
MATERIAL AS SPECIFIED	FINISHING AS SPECIFIED	SCALE NONE
PART NAME Exterior Illumination - Front & Rear		
PART NUMBER	REV	SHEET
	1	25 of 61
		SIZE A0

**Body Controller Front**  
U, W X021 X010 X011 X012 X013 X014

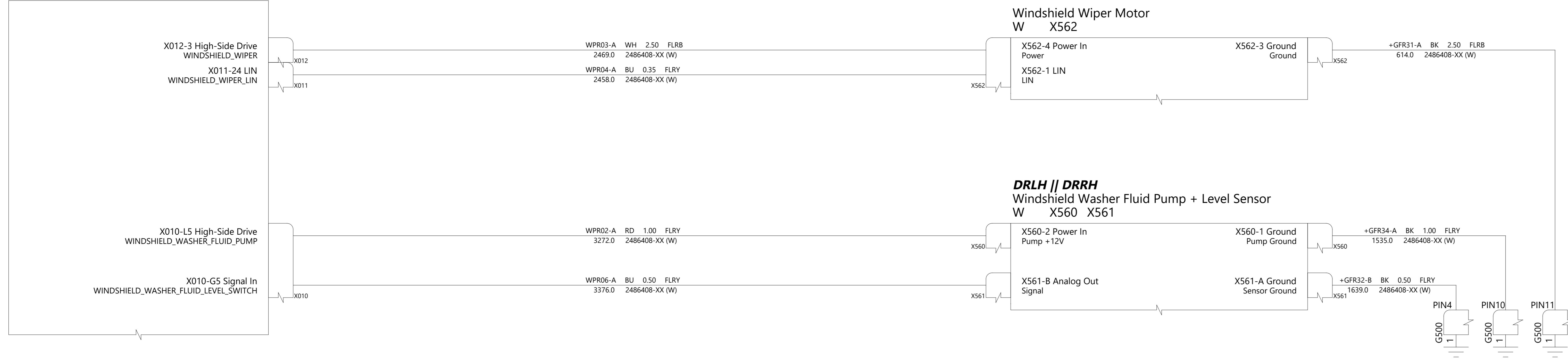

**Body Controller Right**  
B, W, J, D X051 X052 X054 X060A/B X062 X053A/B X055 X056 X058 X059

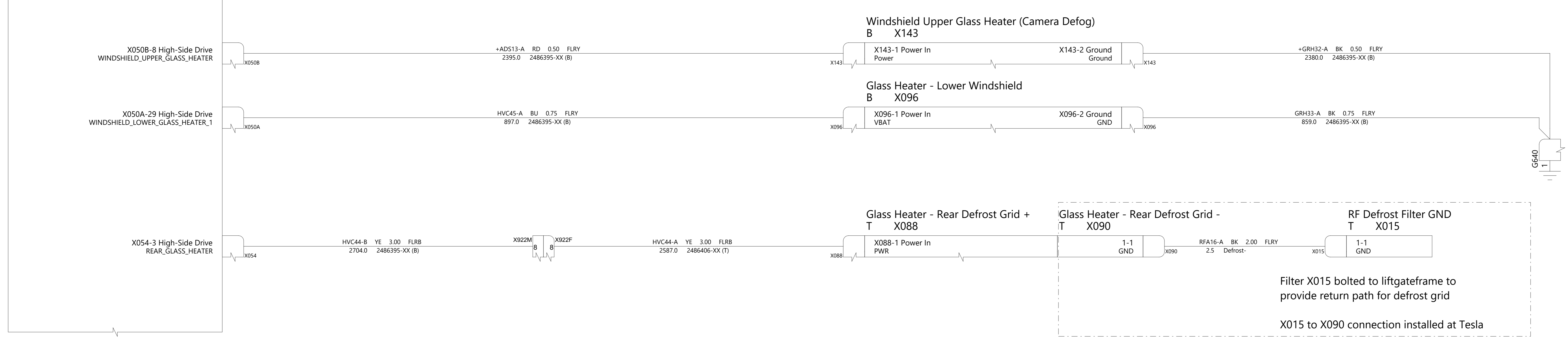

THE INFORMATION CONTAINED HEREIN IS DEEMED TO BE CONFIDENTIAL, PROPRIETARY, AND A TRADE SECRET OF TESLA MOTORS. THIS INFORMATION MAY NOT BE USED, REPRODUCED, OR DISCLOSED AS THE DIRECT OR INDIRECT BASIS FOR THE DEVELOPMENT, MANUFACTURE, OR SALE OF PROCESSES OR PRODUCTS WITHOUT THE EXPRESSED WRITTEN CONSENT OF TESLA MOTORS.

DRAWN	CHECKED	APPROVED
MATERIAL AS SPECIFIED	FINISHING AS SPECIFIED	SCALE NONE
PART NAME Exteriors - Defrost & Wipers		
PART NUMBER	REV	SHEET
	1	26 of 61
		SIZE A0

Body Controller Front  
U, W X021 X011 X012 X013 X014

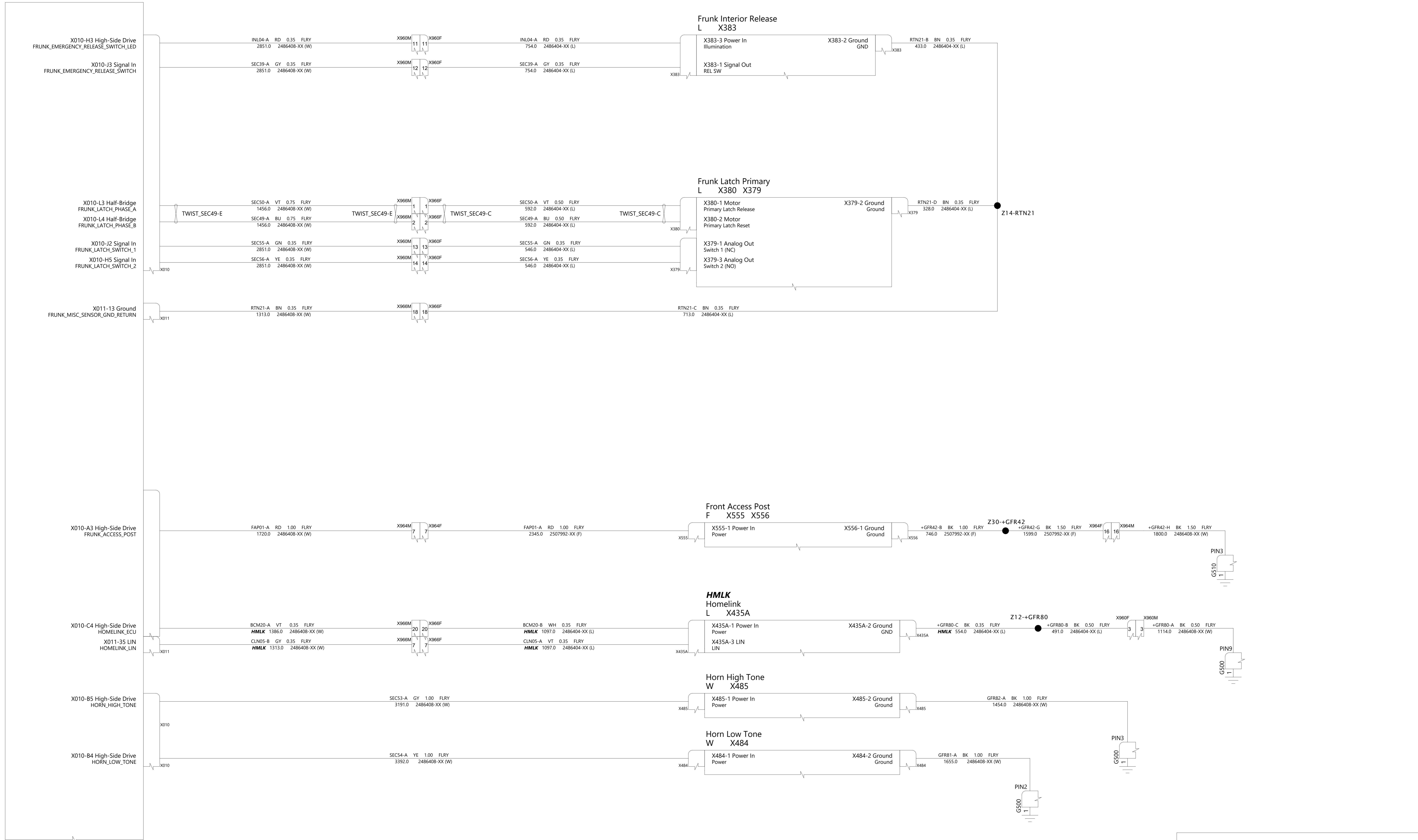

THE INFORMATION CONTAINED HEREIN IS DEEMED TO BE CONFIDENTIAL, PROPRIETARY, AND A TRADE SECRET OF TESLA MOTORS. THIS INFORMATION MAY NOT BE USED, REPRODUCED, OR DISCLOSED AS THE DIRECT OR INDIRECT BASIS FOR THE DEVELOPMENT, MANUFACTURE, OR SALE OF PROCESSES OR PRODUCTS WITHOUT THE EXPRESSED WRITTEN CONSENT OF TESLA MOTORS.

DRAWN	CHECKED	APPROVED
MATERIAL AS SPECIFIED	FINISHING AS SPECIFIED	SCALE NONE
PART NAME Frunk Actuators/Sensors		
PART NUMBER	REV	SHEET
	1	27 of 61
		SIZE A0

EPAS  
W X168 X169 X171 X170

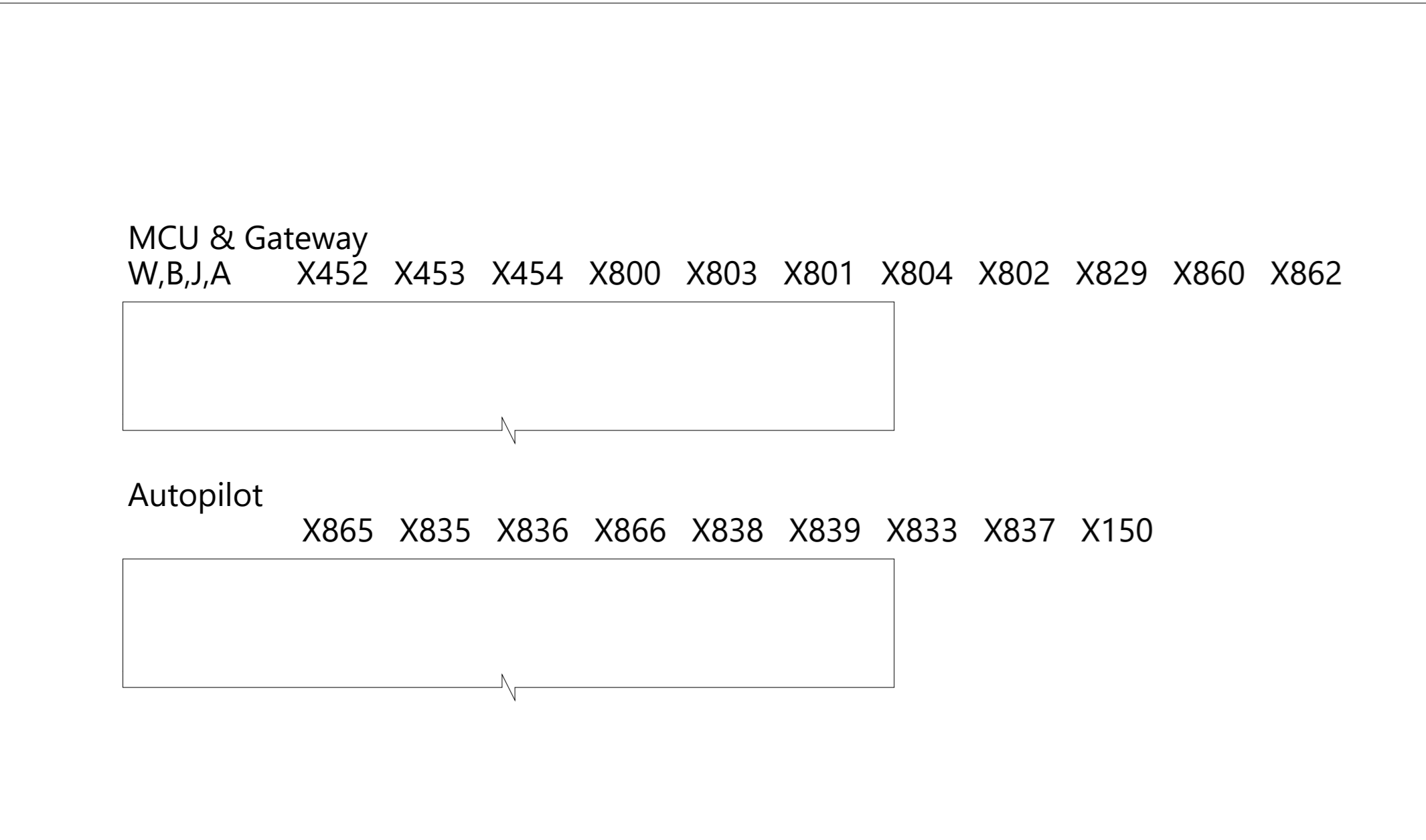
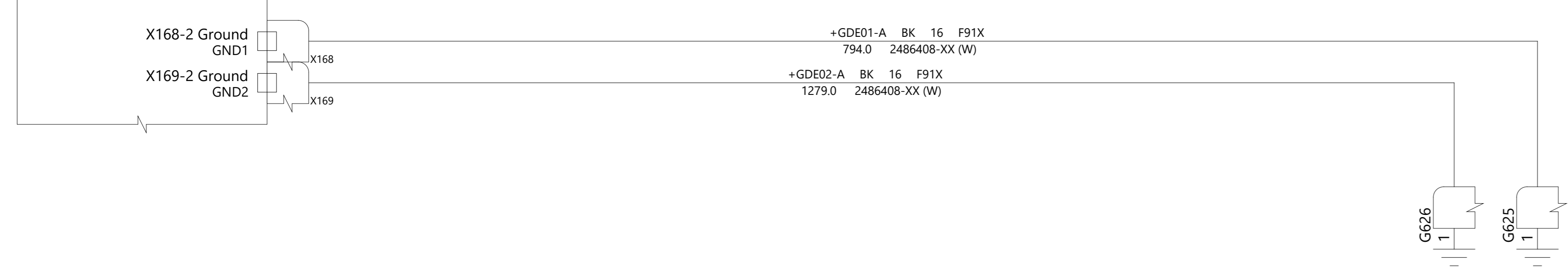

LOCALLY GROUNDED TO CHASSIS

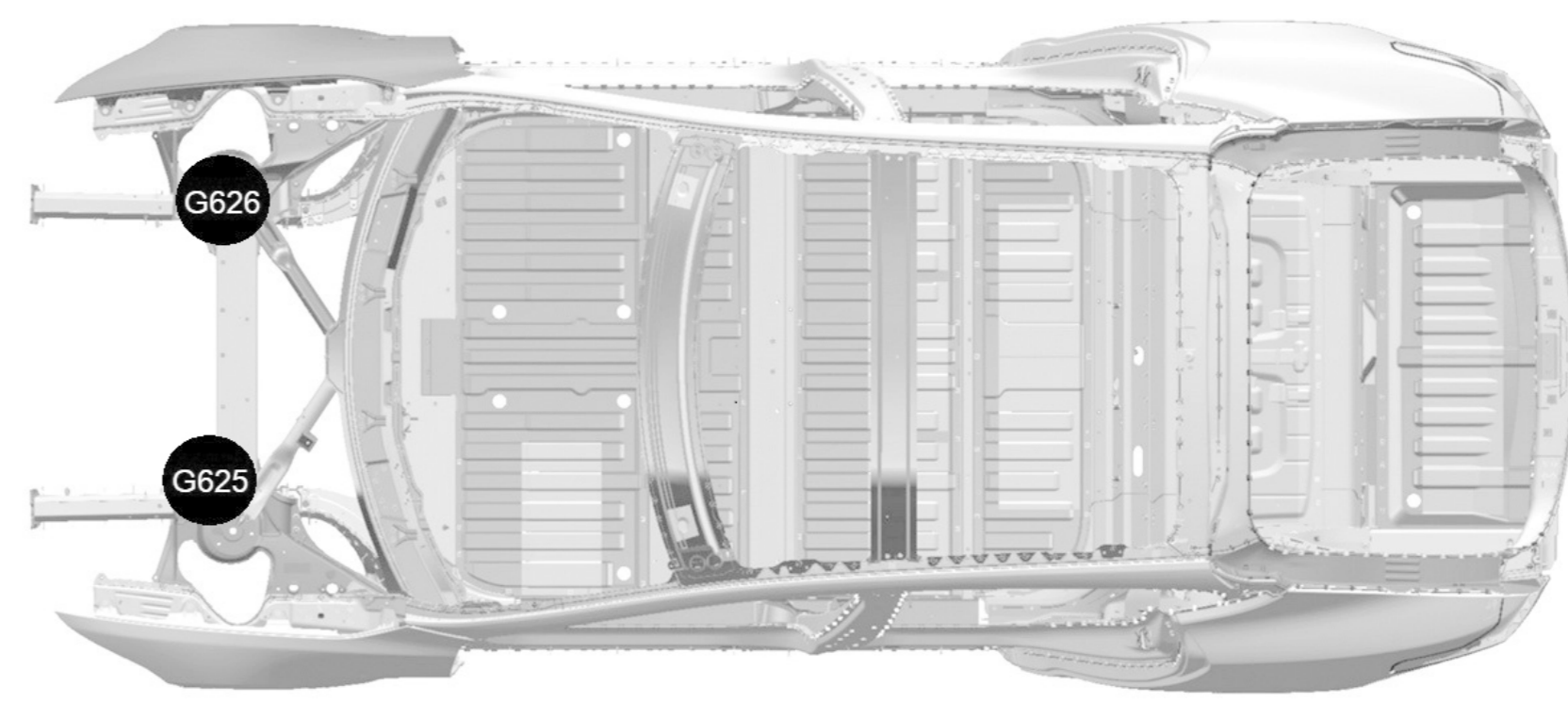

**TESLA**

THE INFORMATION CONTAINED HEREIN IS DEEMED TO BE CONFIDENTIAL, PROPRIETARY, AND A TRADE SECRET OF TESLA MOTORS. THIS INFORMATION MAY NOT BE USED, REPRODUCED, OR DISCLOSED AS THE DIRECT OR INDIRECT BASIS FOR THE DEVELOPMENT, MANUFACTURE, OR SALE OF PROCESSES OR PRODUCTS WITHOUT THE EXPRESSED WRITTEN CONSENT OF TESLA MOTORS.

DRAWN	CHECKED	APPROVED
-------	---------	----------

MATERIAL AS SPECIFIED	FINISHING AS SPECIFIED	SCALE NONE
--------------------------	---------------------------	---------------

PART NAME  
Grounding: Front Center

PART NUMBER	REV	SHEET	SIZE
	1	28 of 61	A0

Body Controller Left  
A,W,J,D X030A/B X031 X032 X034 X038A/B X039 X037 X033A/B X035 X036

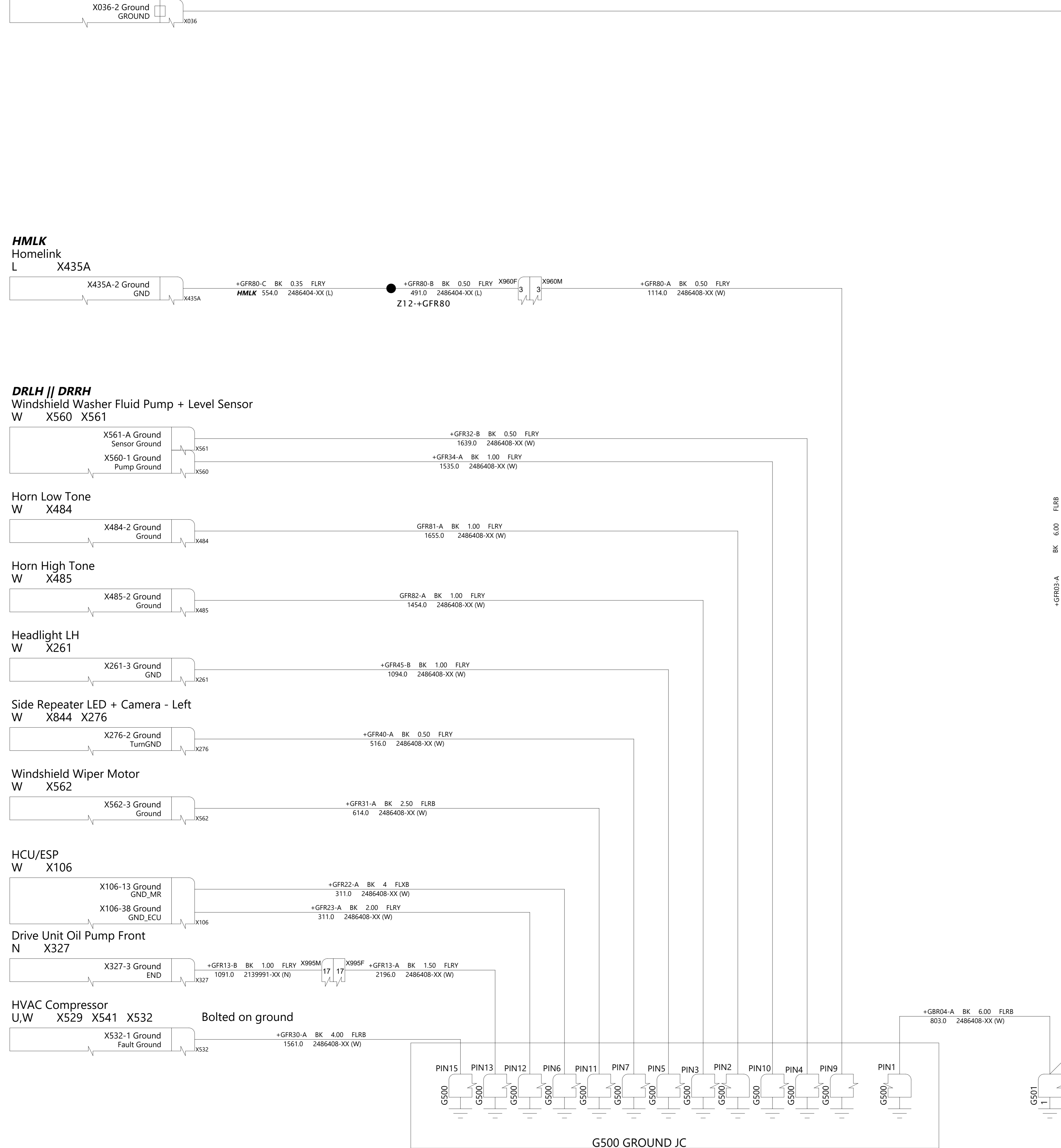

Body Controller Right  
X050A/B X051 X052 X054 X060A/B  
B,W,J,D X062 X053A/B X055 X056 X058 X059

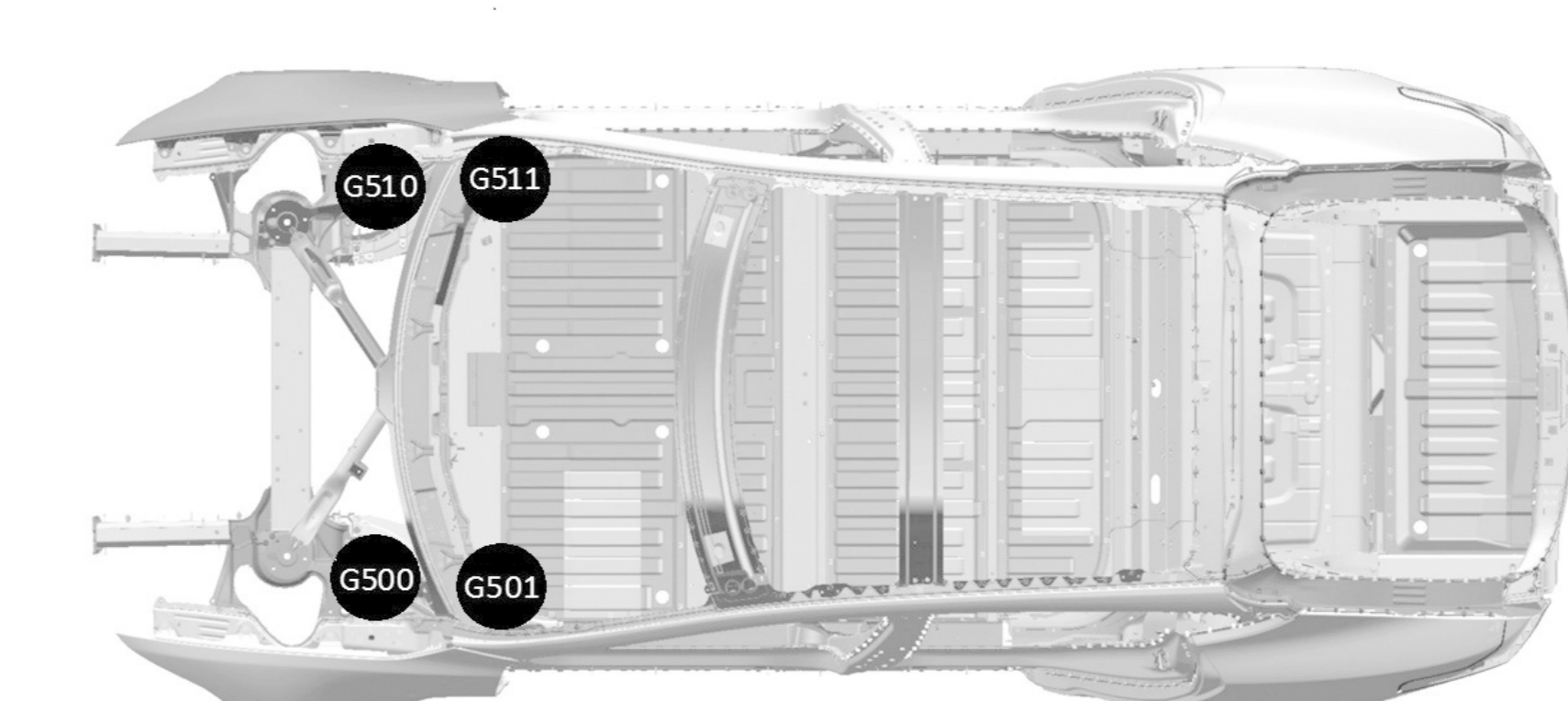
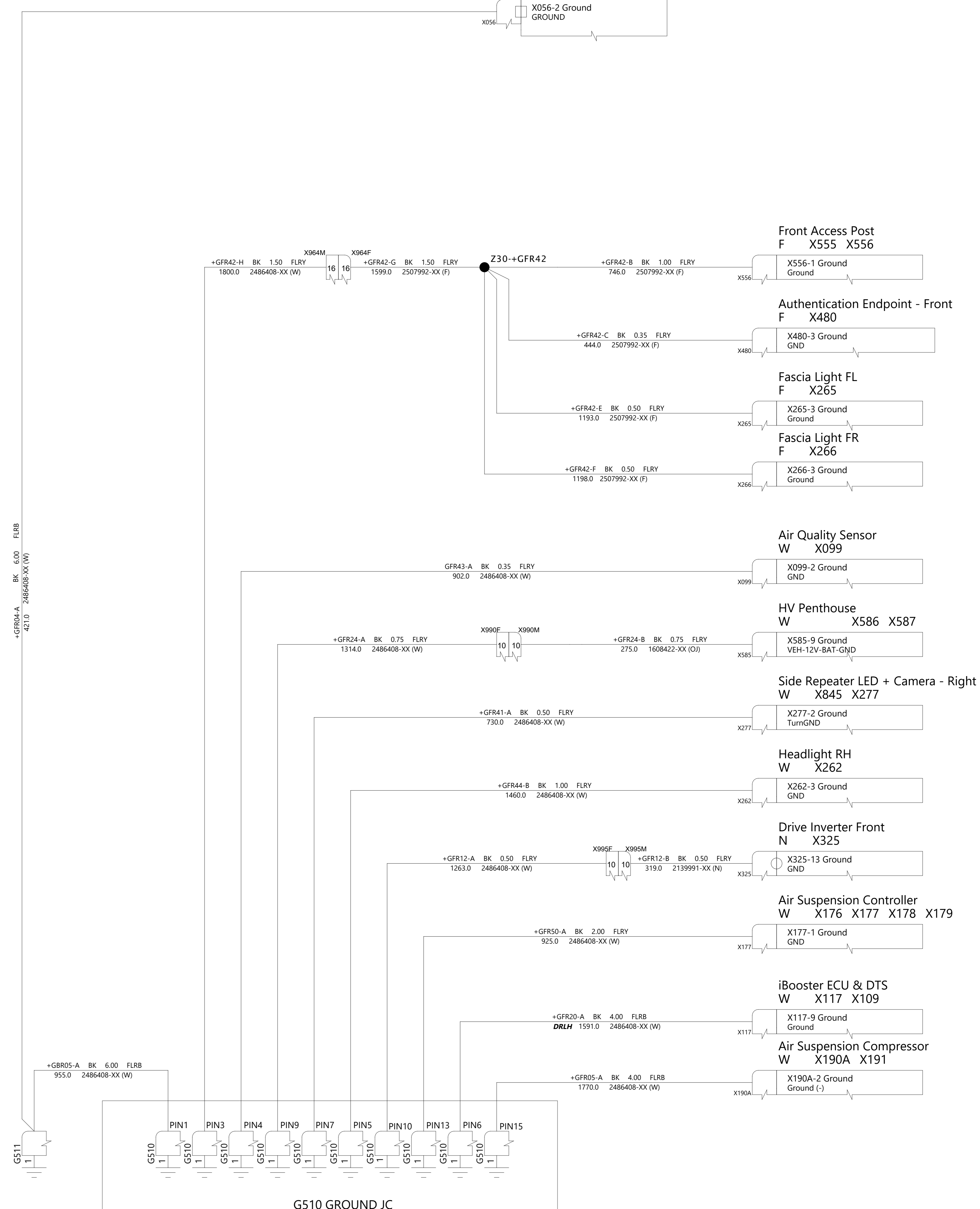

**TESLA**

THE INFORMATION CONTAINED HEREIN IS DEEMED TO BE CONFIDENTIAL, PROPRIETARY, AND A TRADE SECRET OF TESLA MOTORS. THIS INFORMATION MAY NOT BE USED, REPRODUCED, OR DISCLOSED AS THE DIRECT OR INDIRECT BASIS FOR THE DEVELOPMENT, MANUFACTURE, OR SALE OF PROCESSES OR PRODUCTS WITHOUT THE EXPRESSED WRITTEN CONSENT OF TESLA MOTORS.

DRAWN	CHECKED	APPROVED
MATERIAL AS SPECIFIED	FINISHING AS SPECIFIED	SCALE NONE
PART NAME Grounding: Front Left & Right		
PART NUMBER	REV	SHEET
	1	29 OF 61
		SIZE A0

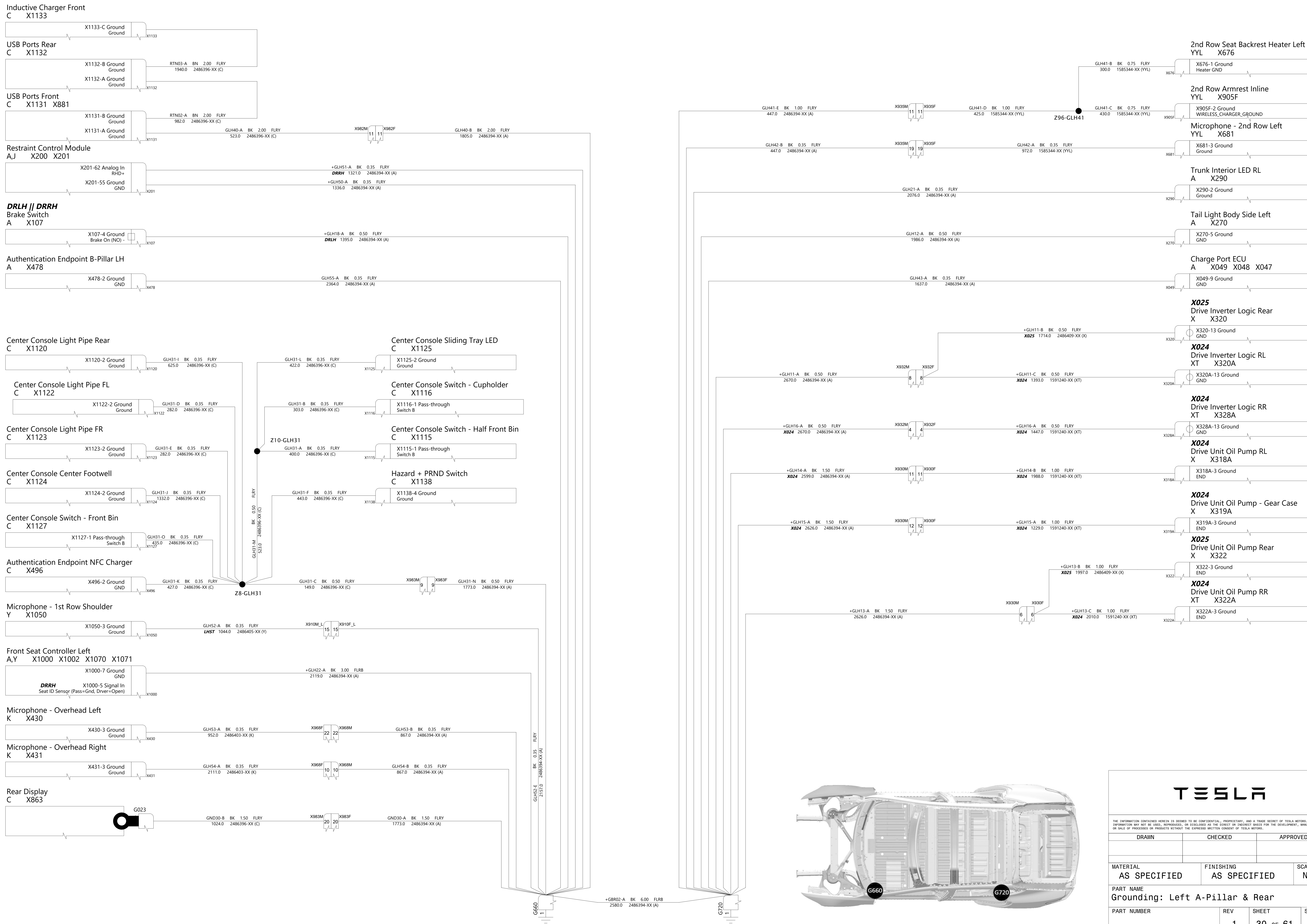

**TESLA**

THE INFORMATION CONTAINED HEREIN IS DEEMED TO BE CONFIDENTIAL, PROPRIETARY, AND A TRADE SECRET OF TESLA MOTORS. THIS INFORMATION MAY NOT BE USED, REPRODUCED, OR DISCLOSED AS THE DIRECT OR INDIRECT BASIS FOR THE DEVELOPMENT, MANUFACTURE, OR SALE OF PROCEDES OR PRODUCTS WITHOUT THE EXPRESSED WRITTEN CONSENT OF TESLA MOTORS.

DRAWN	CHECKED	APPROVED
-------	---------	----------

MATERIAL AS SPECIFIED	FINISHING AS SPECIFIED	SCALE NONE
--------------------------	---------------------------	---------------

PART NAME  
**Grounding: Left A-Pillar & Rear**

PART NUMBER	REV	SHEET	SIZE
	1	30 OF 61	A0

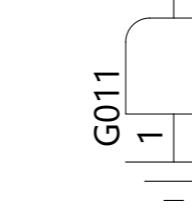
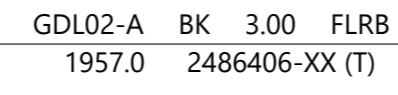
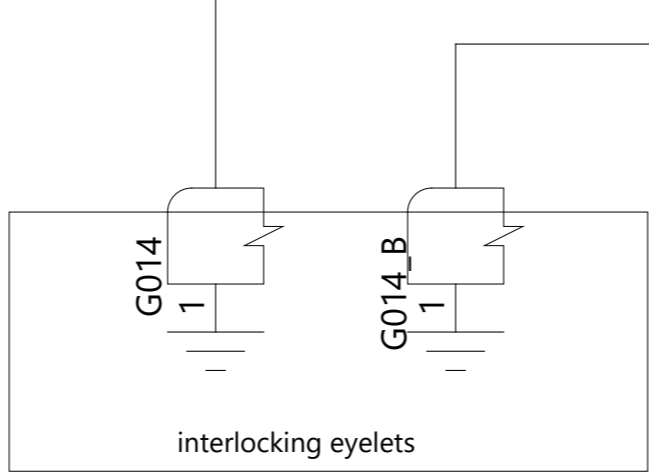
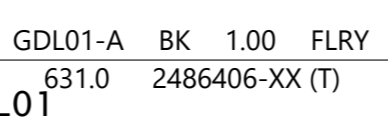
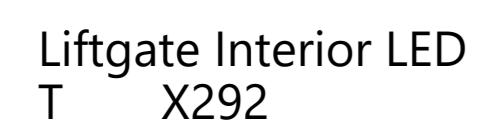
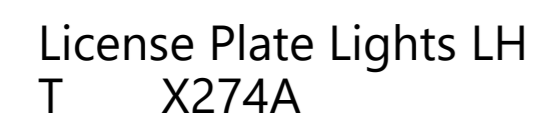
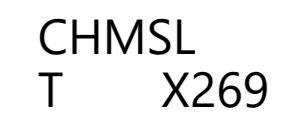
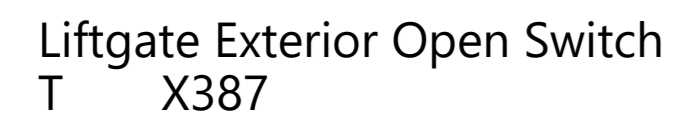
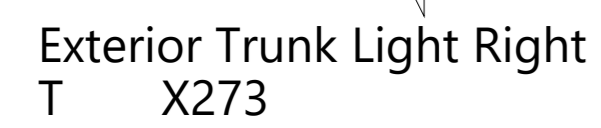
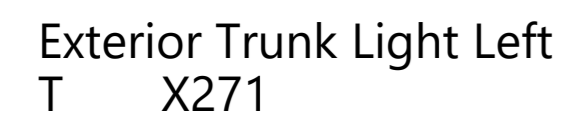

bonds to header above C-pillar to provide RF GND

**TESLA**

THE INFORMATION CONTAINED HEREIN IS DEEMED TO BE CONFIDENTIAL, PROPRIETARY, AND A TRADE SECRET OF TESLA MOTORS. THIS INFORMATION MAY NOT BE USED, REPRODUCED, OR DISCLOSED AS THE DIRECT OR INDIRECT BASIS FOR THE DEVELOPMENT, MANUFACTURE, OR SALE OF PROCESSES OR PRODUCTS WITHOUT THE EXPRESSED WRITTEN CONSENT OF TESLA MOTORS.

DRAWN	CHECKED	APPROVED

MATERIAL AS SPECIFIED	FINISHING AS SPECIFIED	SCALE NONE
--------------------------	---------------------------	---------------

PART NAME  
Grounding: Liftgate

PART NUMBER	REV	SHEET	SIZE
	1	31 of 61	A0

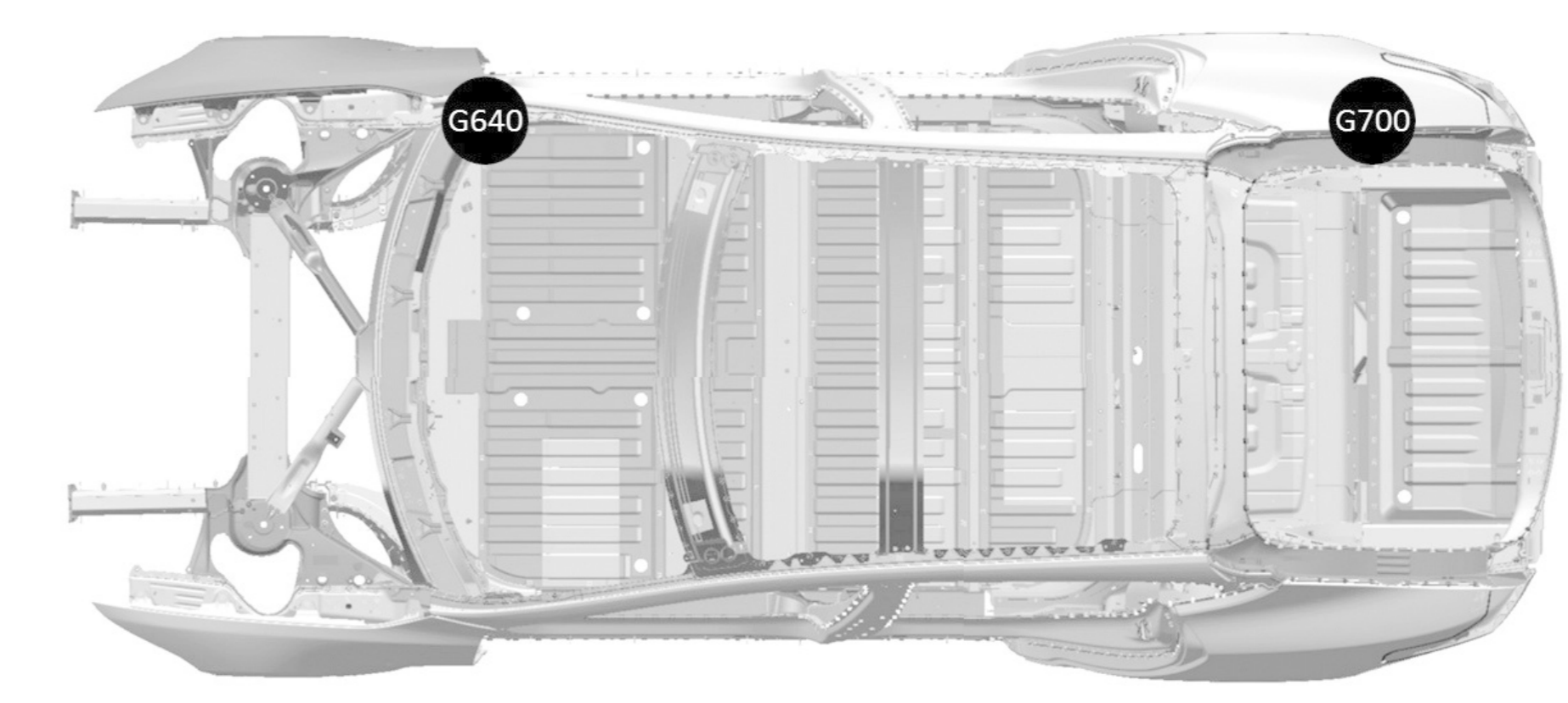
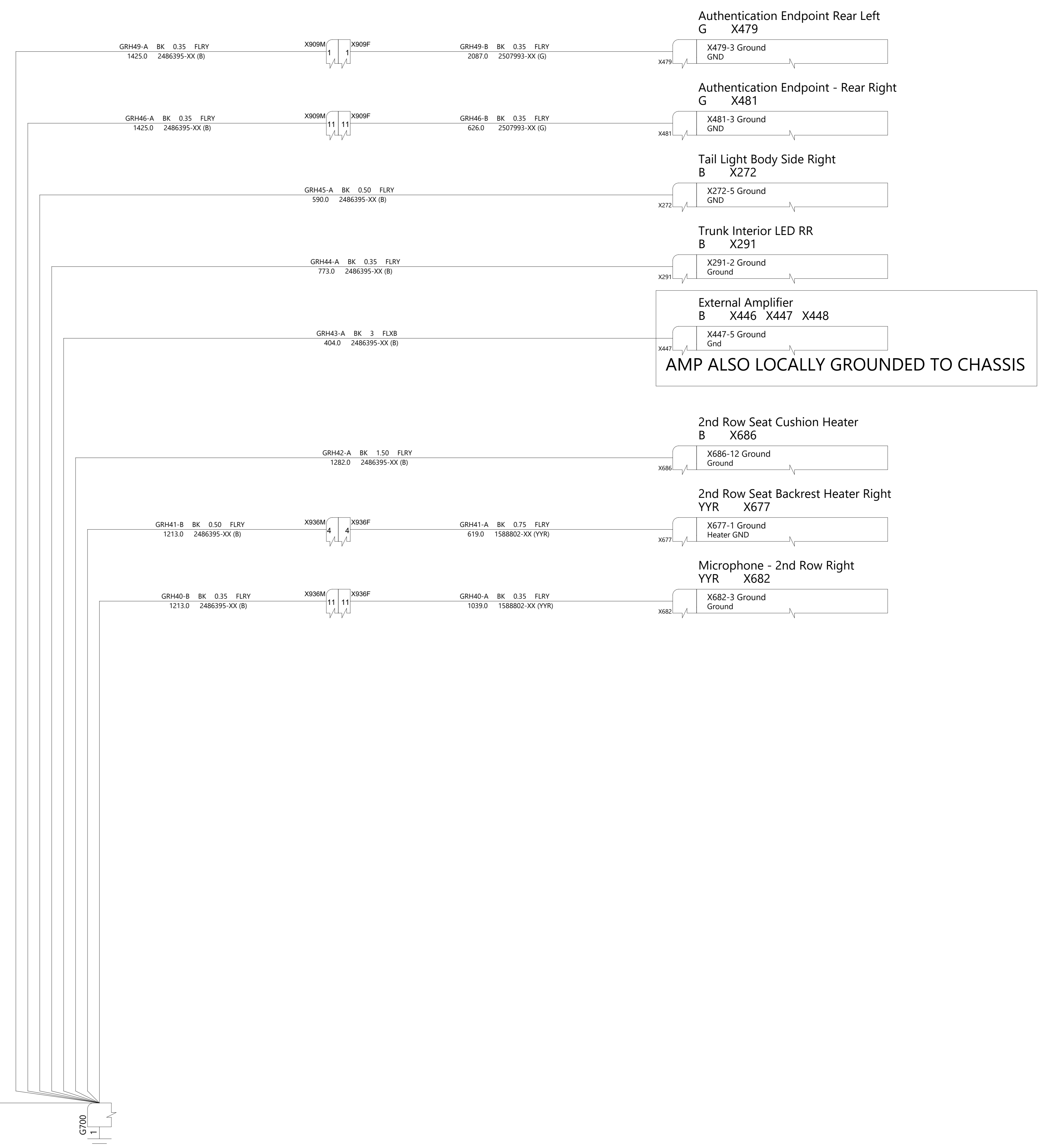
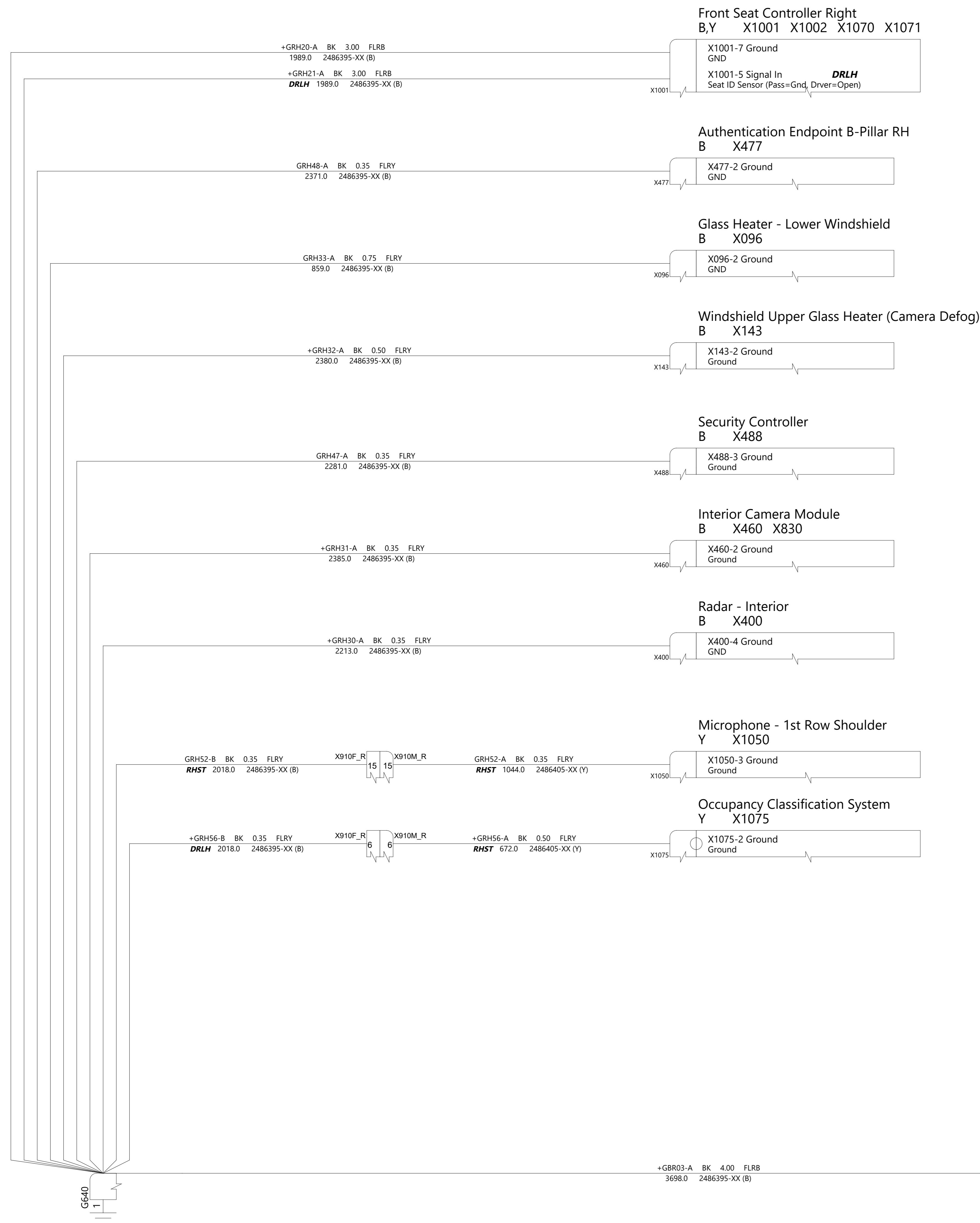

<b>TESLA</b>			
<small>THE INFORMATION CONTAINED HEREIN IS DEEMED TO BE CONFIDENTIAL, PROPRIETARY, AND A TRADE SECRET OF TESLA MOTORS. THIS INFORMATION MAY NOT BE USED, REPRODUCED, OR DISCLOSED AS THE DIRECT OR INDIRECT BASIS FOR THE DEVELOPMENT, MANUFACTURE, OR SALE OF PROCESSES OR PRODUCTS WITHOUT THE EXPRESSED WRITTEN CONSENT OF TESLA MOTORS.</small>			
DRAWN	CHECKED	APPROVED	
MATERIAL AS SPECIFIED		FINISHING AS SPECIFIED	SCALE NONE
PART NAME Grounding: Right A-Pillar & Rear			
PART NUMBER	REV	SHEET	SIZE
	1	32 OF 61	A0



Body Controller Right  
B,W,J,D X051 X052 X054 X060A/B X062 X053A/B X055 X056 X058 X059

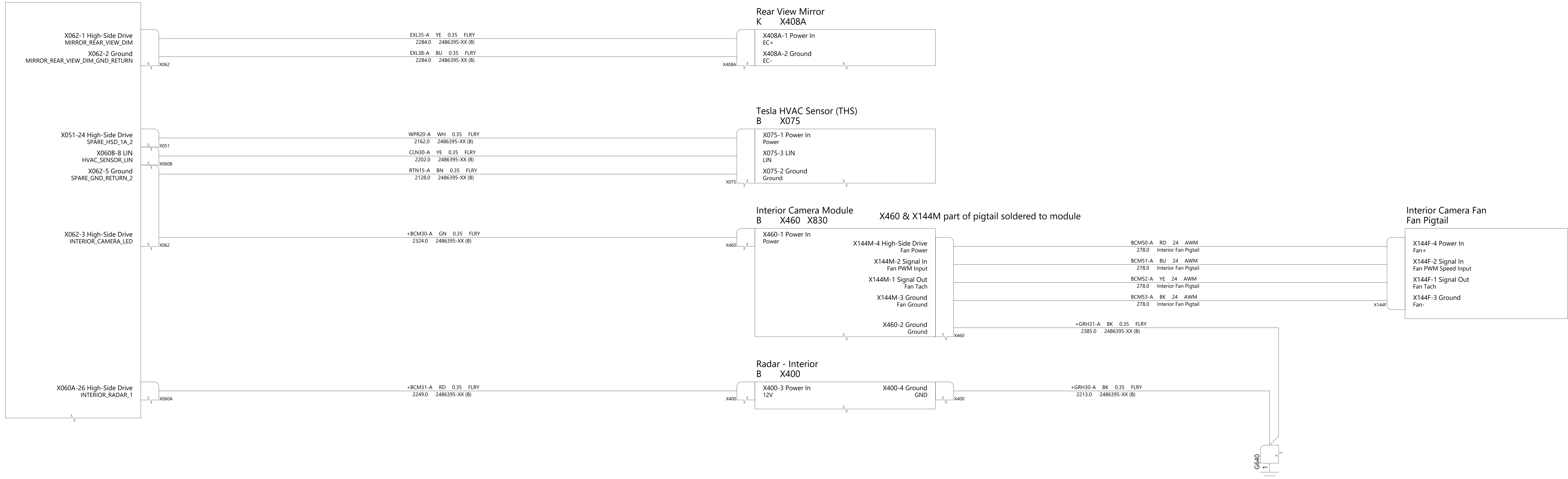

Body Controller Left  
A,W,J,D X031 X032 X034 X038A/B X039 X037 X033A/B X035 X036

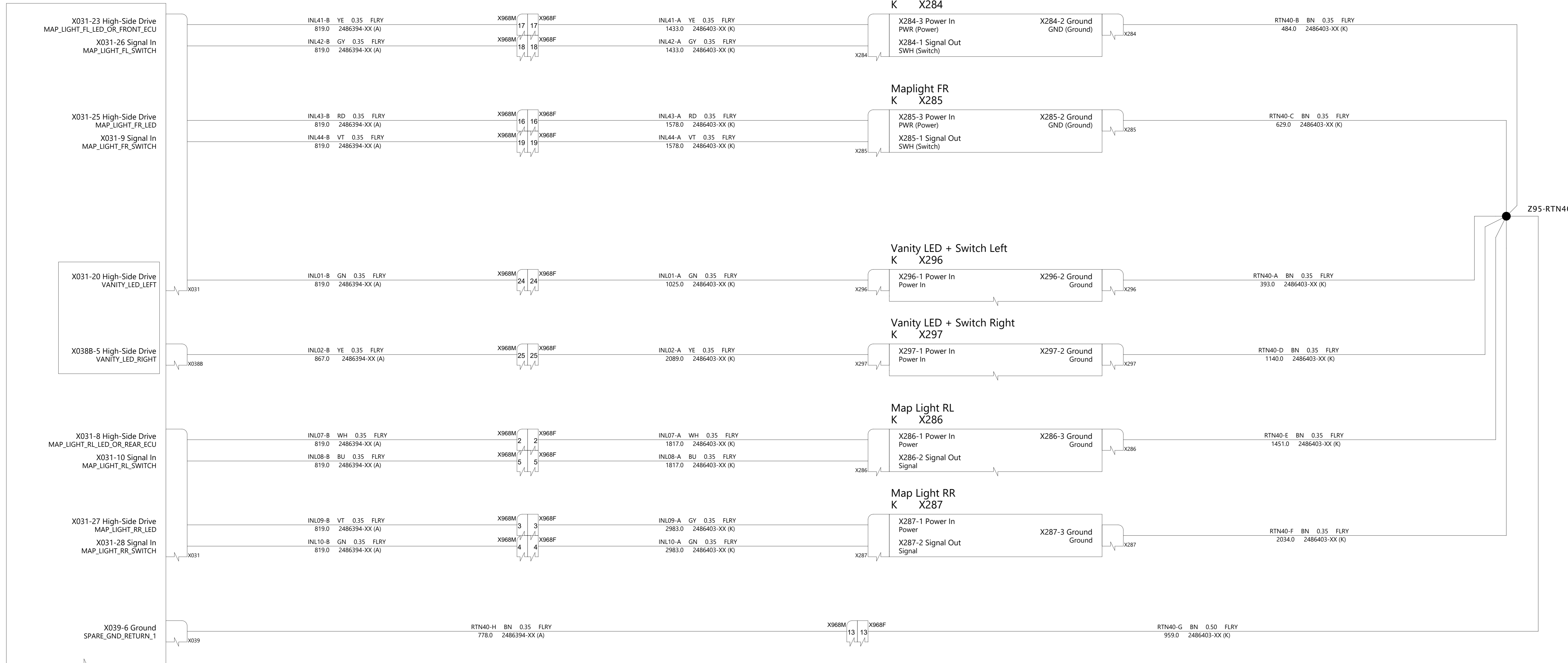

THE INFORMATION CONTAINED HEREIN IS DEEMED TO BE CONFIDENTIAL, PROPRIETARY, AND A TRADE SECRET OF TESLA MOTORS. THIS INFORMATION MAY NOT BE USED, REPRODUCED, OR DISCLOSED AS THE DIRECT OR INDIRECT BASIS FOR THE DEVELOPMENT, MANUFACTURE, OR SALE OF PROCESSES OR PRODUCTS WITHOUT THE EXPRESSED WRITTEN CONSENT OF TESLA MOTORS.

DRAWN	CHECKED	APPROVED
MATERIAL AS SPECIFIED	FINISHING AS SPECIFIED	SCALE NONE
PART NAME Headliner		
PART NUMBER	REV 1	SHEET 33 OF 61
		SIZE A0

HV Penthouse  
W X586 X587

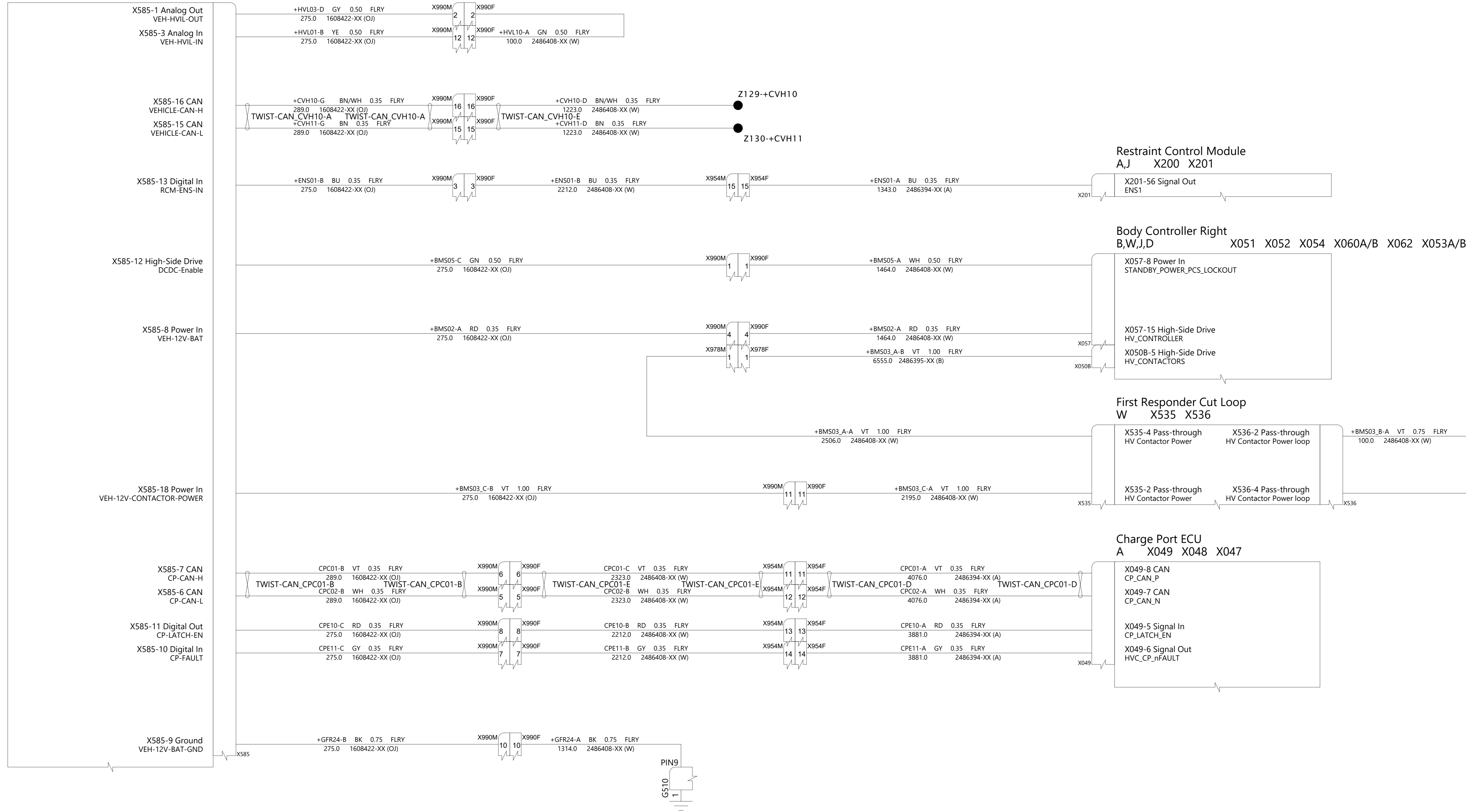

HVIL CIRCUITS ONLY USED FOR SUBASSEMBLY TESTING

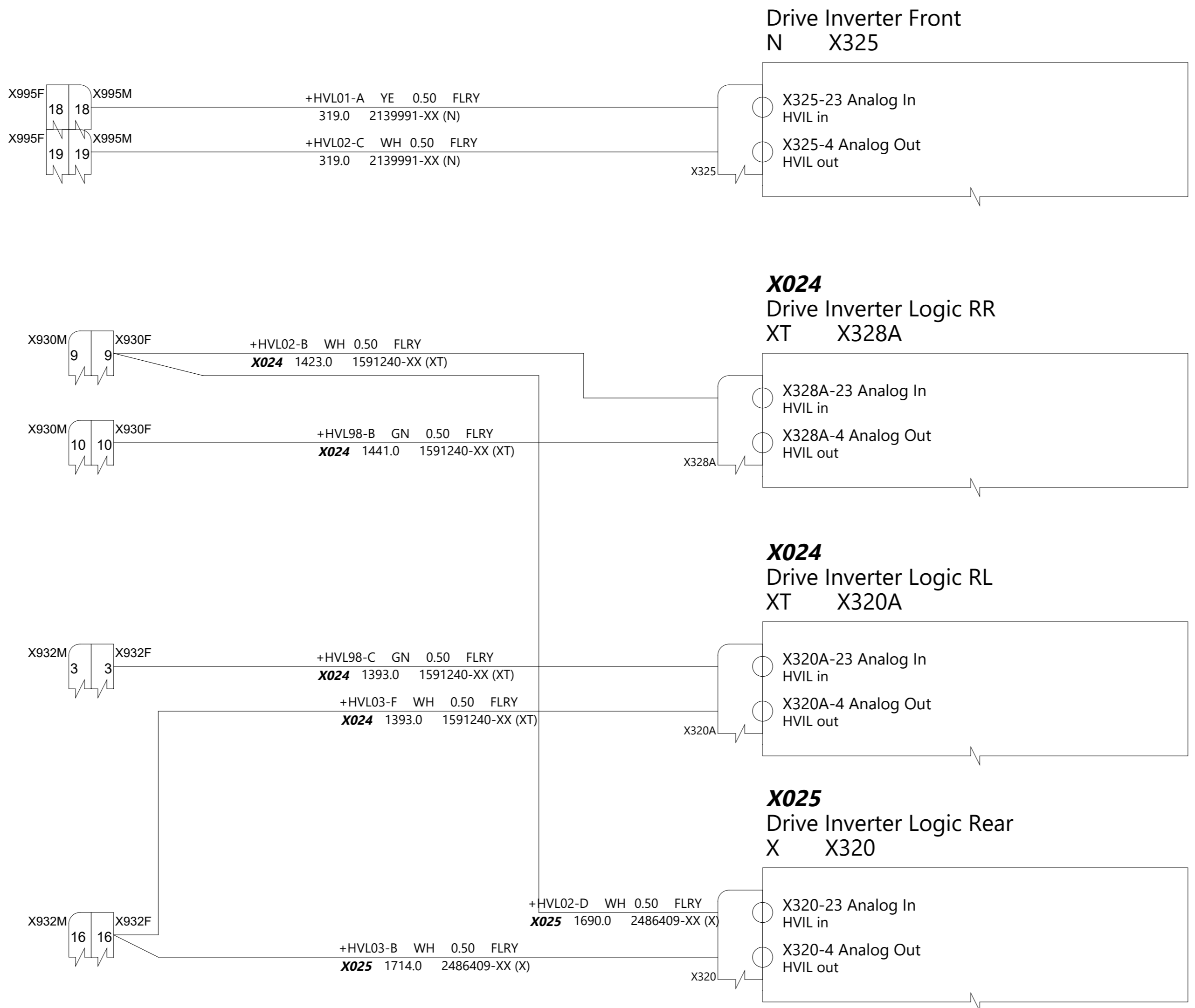

**TESLA**

THE INFORMATION CONTAINED HEREIN IS DEEMED TO BE CONFIDENTIAL, PROPRIETARY, AND A TRADE SECRET OF TESLA MOTORS. THIS INFORMATION MAY NOT BE USED, REPRODUCED, OR DISCLOSED AS THE DIRECT OR INDIRECT BASIS FOR THE DEVELOPMENT, MANUFACTURE, OR SALE OF PROCESSES OR PRODUCTS WITHOUT THE EXPRESSED WRITTEN CONSENT OF TESLA MOTORS.

DRAWN	CHECKED	APPROVED
MATERIAL AS SPECIFIED		SCALE NONE
PART NAME HV Penthouse & HVIL		
PART NUMBER	REV 1	SHEET 34 OF 61
		SIZE A0

Body Controller Right  
B,W,J,D

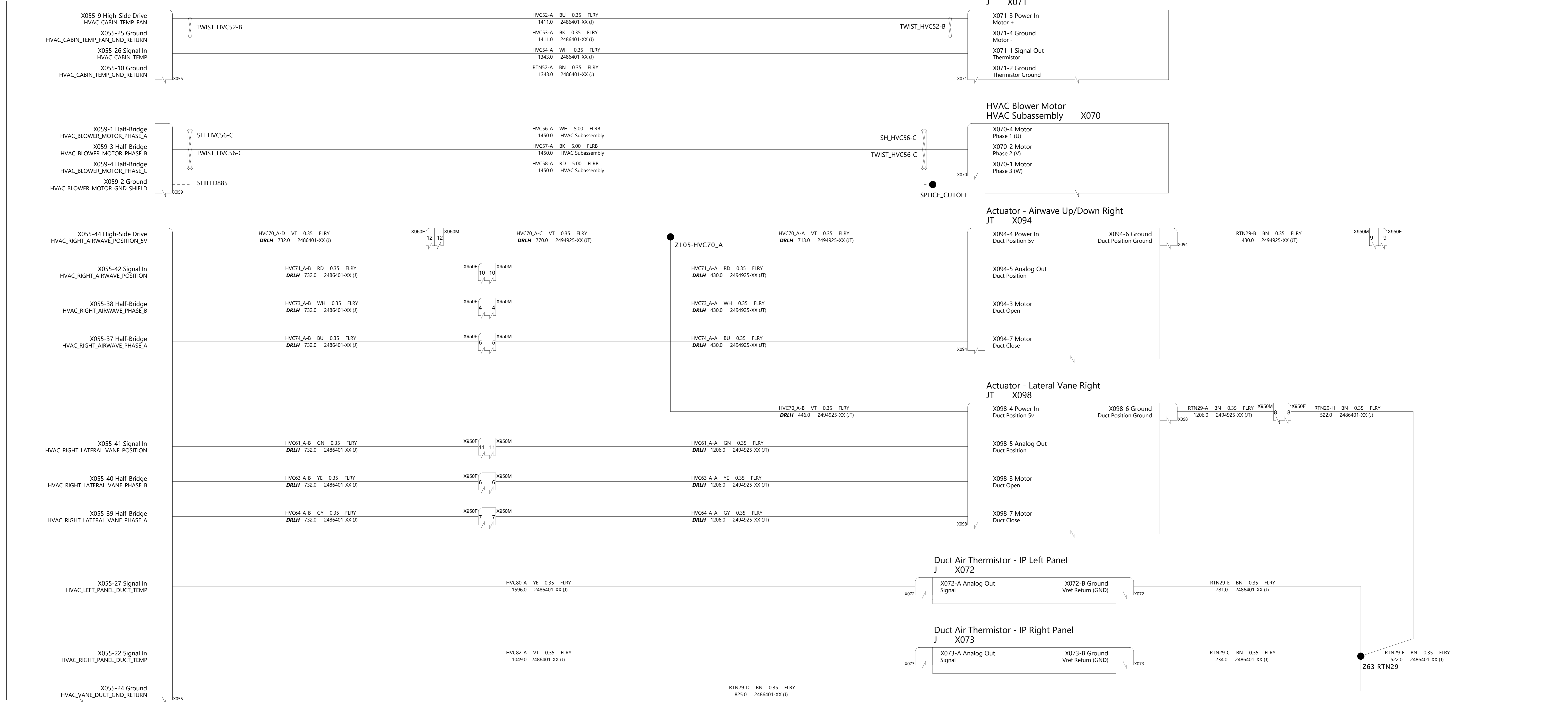

Body Controller Left  
A,W,J,D

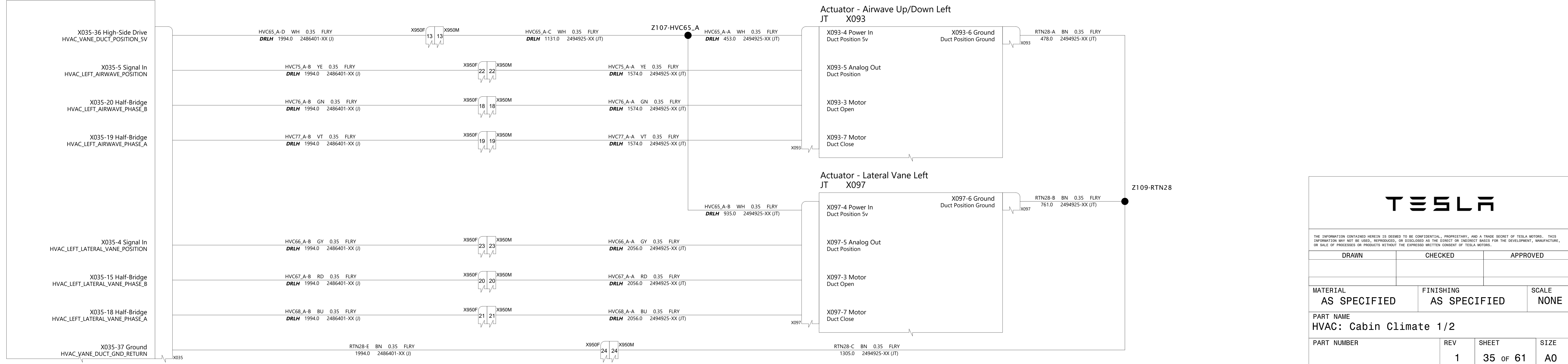

DRAWN				CHECKED		APPROVED	
MATERIAL AS SPECIFIED		FINISHING AS SPECIFIED		SCALE NONE			
PART NAME HVAC: Cabin Climate 1/2							
PART NUMBER		REV 1	SHEET 35 of 61	SCALE A0			

Body Controller Right  
B,W,J,D X051 X052 X054 X060A/B X062 X053A/B X055 X056 X058 X059

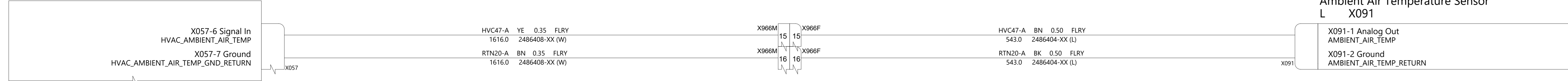

Body Controller Battery  
W X025 X022 X023 X024 X026

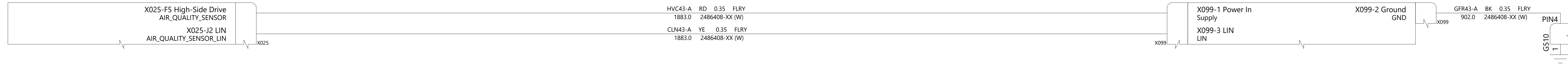

Body Controller Left  
A,W,J,D X031 X032 X034 X038A/B X039 X037 X033A/B X035 X036

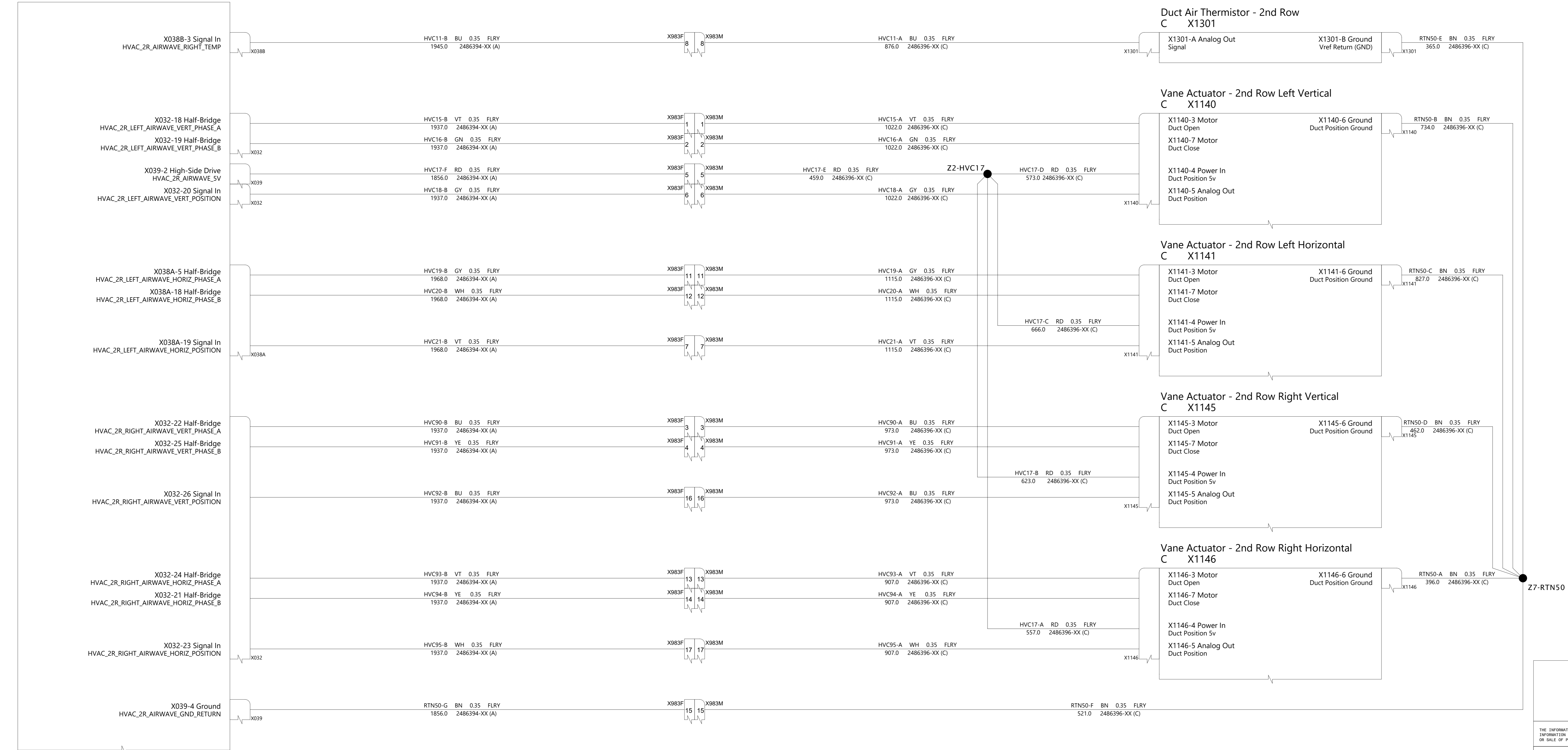

THE INFORMATION CONTAINED HEREIN IS DEEMED TO BE CONFIDENTIAL, PROPRIETARY, AND A TRADE SECRET OF TESLA MOTORS. THIS INFORMATION MAY NOT BE USED, REPRODUCED, OR DISCLOSED AS THE DIRECT OR INDIRECT BASIS FOR THE DEVELOPMENT, MANUFACTURE, OR SALE OF PROCESSES OR PRODUCTS WITHOUT THE EXPRESSED WRITTEN CONSENT OF TESLA MOTORS.

DRAWN	CHECKED	APPROVED
MATERIAL AS SPECIFIED	FINISHING AS SPECIFIED	SCALE NONE
PART NAME HVAC: Cabin Climate 2/2		
PART NUMBER	REV	SHEET
	1	36 OF 61
		SIZE A0

Body Controller Right  
B,W,J,D X051 X052 X054 X060A/B X062 X053A/B X055 X056 X058 X059

HVAC Case  
X521 X522 X523 X524 X525 X526 X530 X531 X546 X547 X549 X550 X551 X552 X553 X554 X557

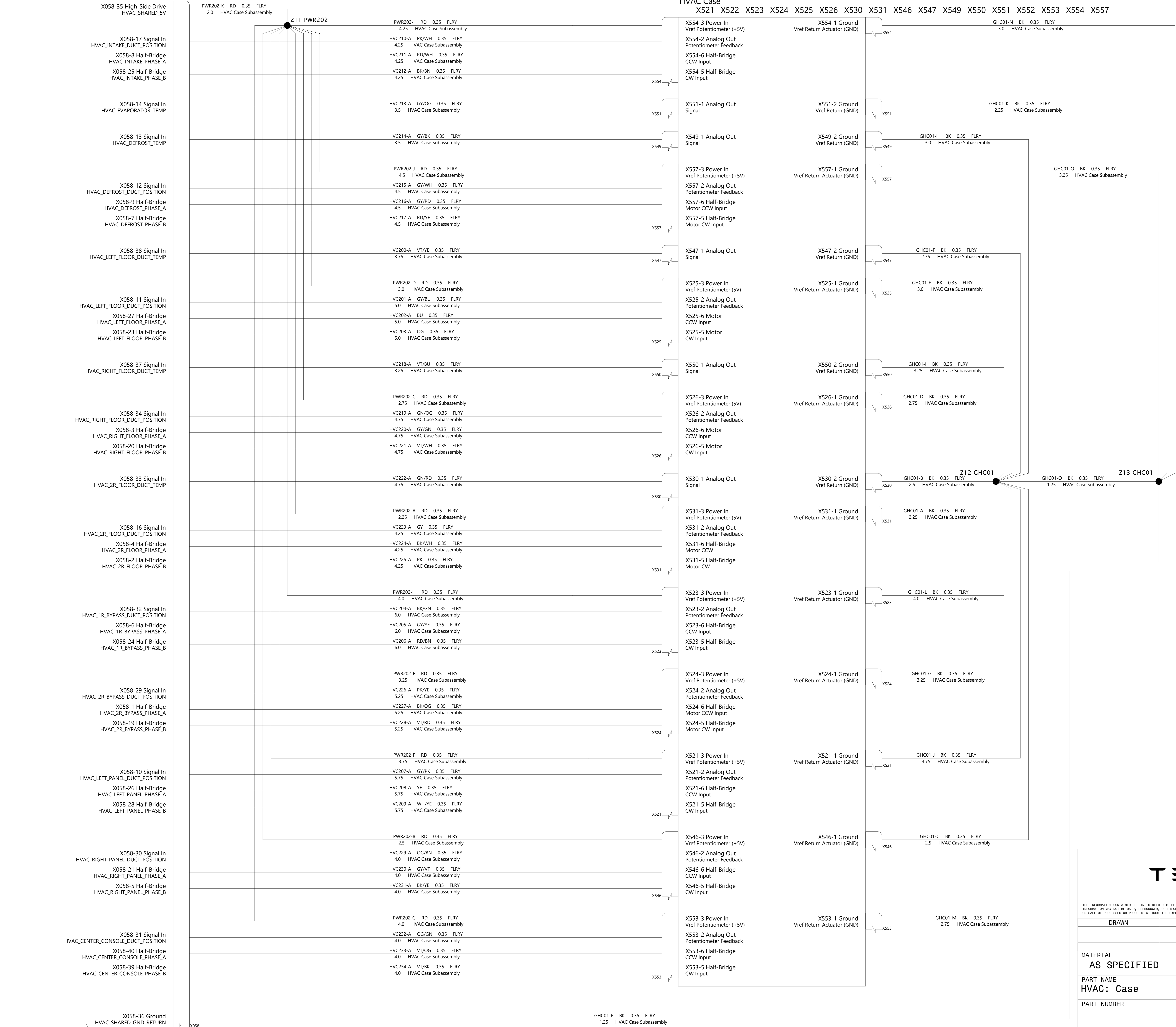

THE INFORMATION CONTAINED HEREIN IS DEEMED TO BE CONFIDENTIAL, PROPRIETARY, AND A TRADE SECRET OF TESLA MOTORS. THIS INFORMATION MAY NOT BE USED, REPRODUCED, OR DISCLOSED AS THE DIRECT OR INDIRECT BASIS FOR THE DEVELOPMENT, MANUFACTURE, OR SALE OF PROCESSES OR PRODUCTS WITHOUT THE EXPRESSED WRITTEN CONSENT OF TESLA MOTORS.

DRAWN	CHECKED	APPROVED
MATERIAL AS SPECIFIED	FINISHING AS SPECIFIED	SCALE NONE
PART NAME HVAC: Case		
PART NUMBER	REV	SHEET
	1	38 of 63
		SIZE A0

Body Controller Front  
U, W X021 X010 X011 X012 X013 X014

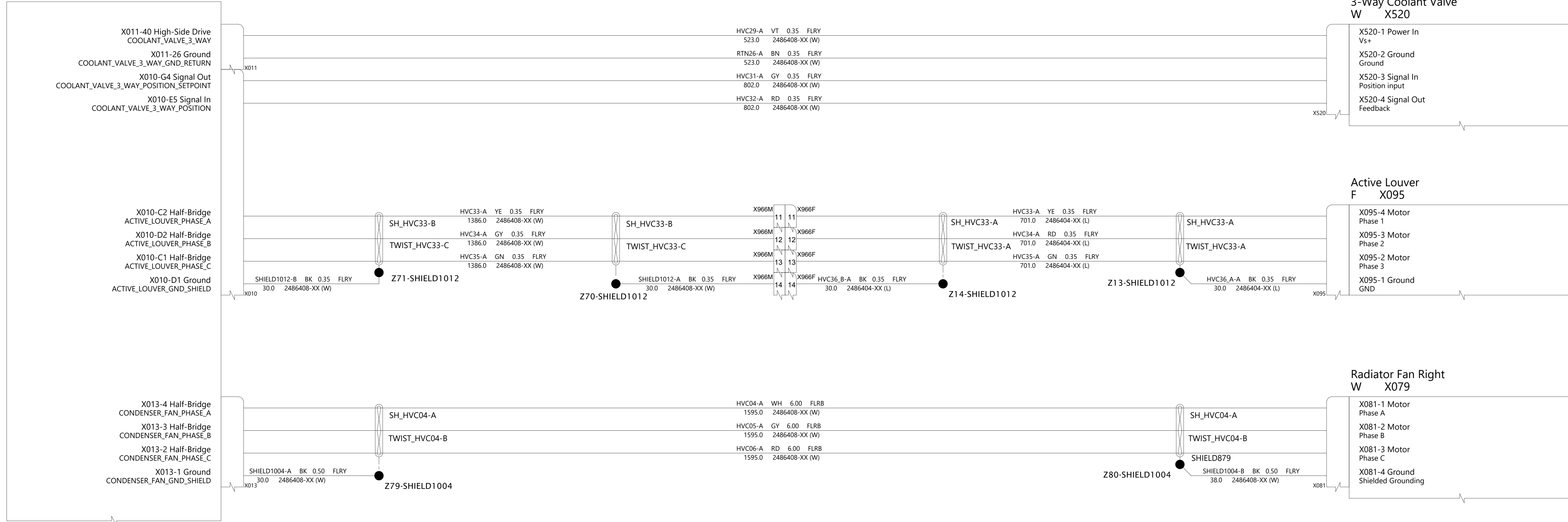

Body Controller Battery  
W X025 X022 X023 X024 X026

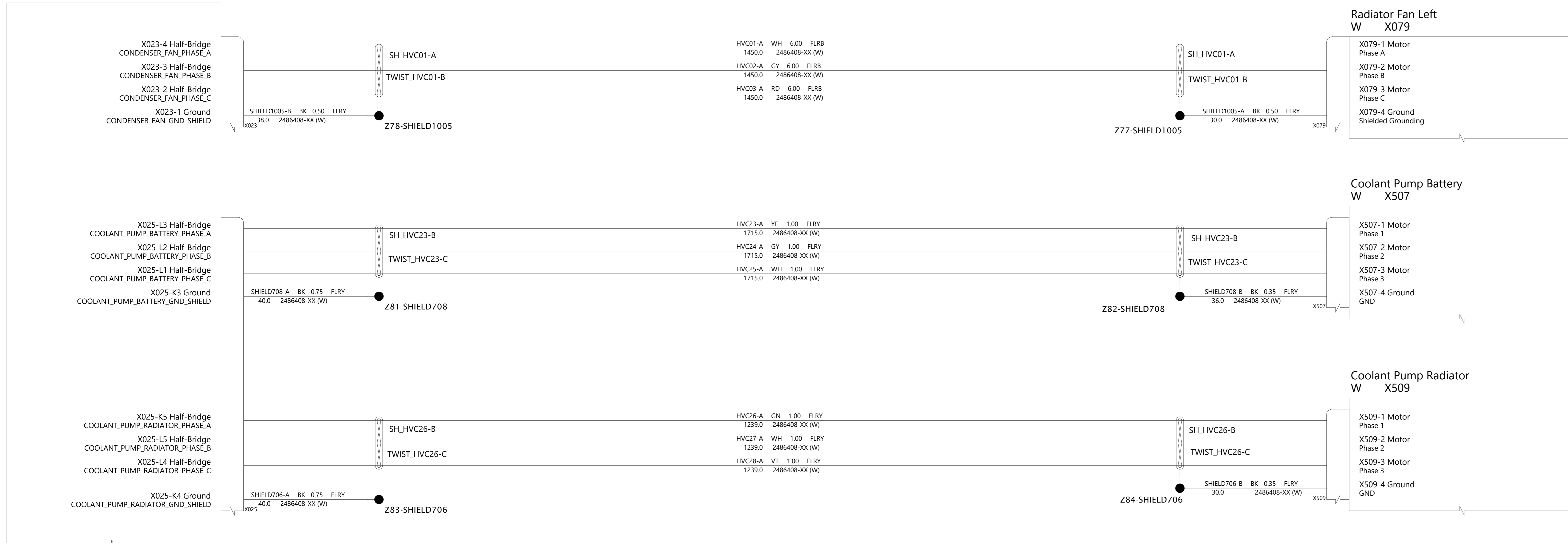

**TESLA**

THE INFORMATION CONTAINED HEREIN IS DEEMED TO BE CONFIDENTIAL, PROPRIETARY, AND A TRADE SECRET OF TESLA MOTORS. THIS INFORMATION MAY NOT BE USED, REPRODUCED, OR DISCLOSED AS THE DIRECT OR INDIRECT BASIS FOR THE DEVELOPMENT, MANUFACTURE, OR SALE OF PROCESSES OR PRODUCTS WITHOUT THE EXPRESSED WRITTEN CONSENT OF TESLA MOTORS.

DRAWN	CHECKED	APPROVED
MATERIAL AS SPECIFIED	FINISHING AS SPECIFIED	SCALE NONE
PART NAME HVAC: Powertrain & Battery		
PART NUMBER	REV	SHEET
	1	38 of 61

**Coolant Pump, Battery**  
U X508

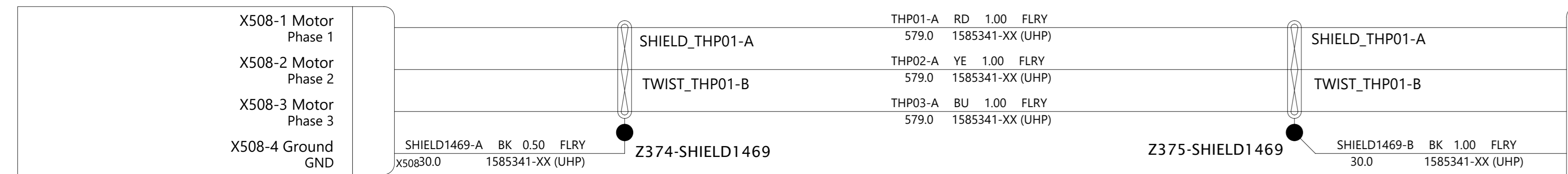

**Coolant Pump, Powertrain**  
U X510

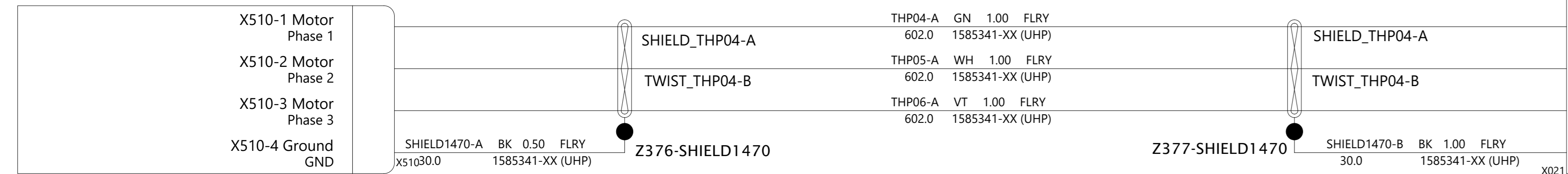

**Coolant Temp Sensor, Battery**  
W X517

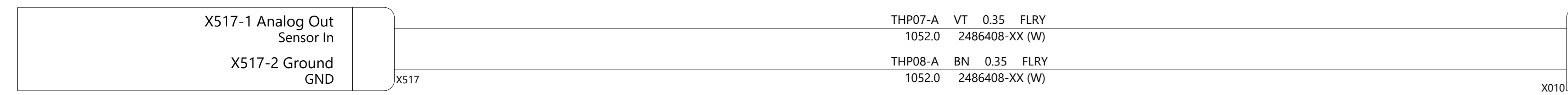

**Coolant Temp Sensor, Powertrain**  
U X518

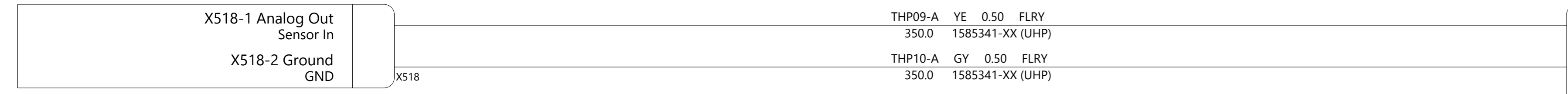

**Refrigerant Temp and Pressure Sensor, Suction**  
U X533



**Refrigerant Temperature and Pressure Sensor - Discharge**  
U X534



**Refrigerant Temperature and Pressure Sensor - Subcool**  
U X513



**Coolant Level Sensor, Heat Pump**  
U X511

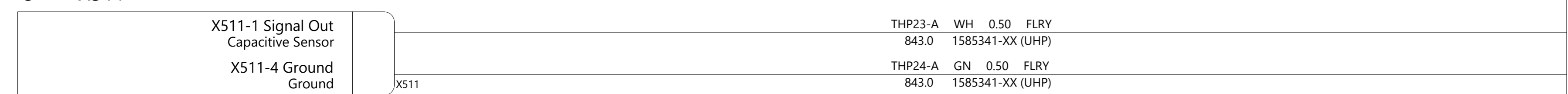

**Refrigerant Evap SOV**  
U X516

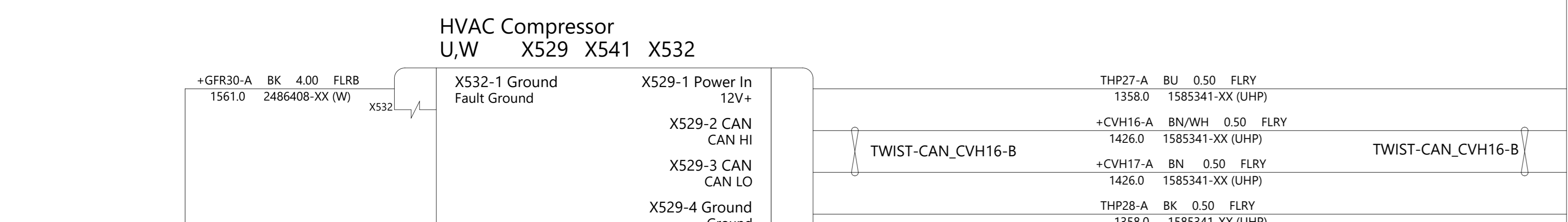
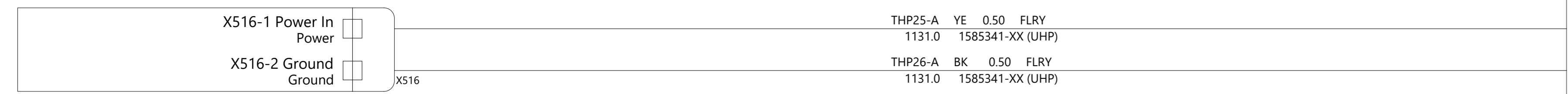

**Body Controller Front**  
U, W X021 X010 X011 X012 X013 X014

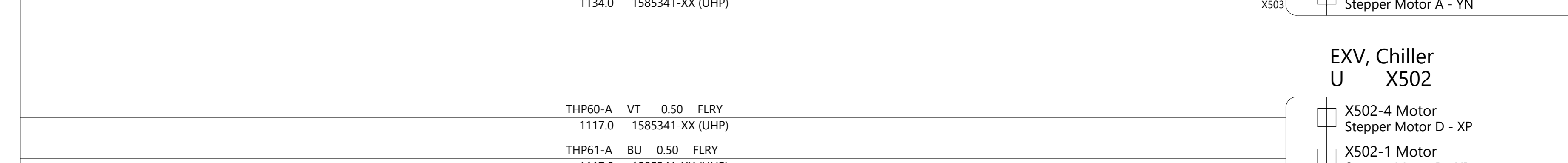
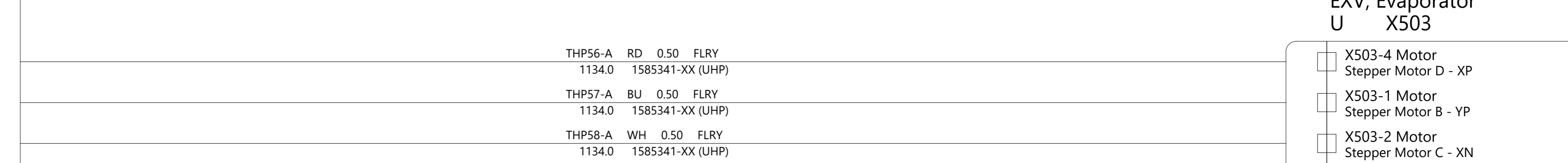
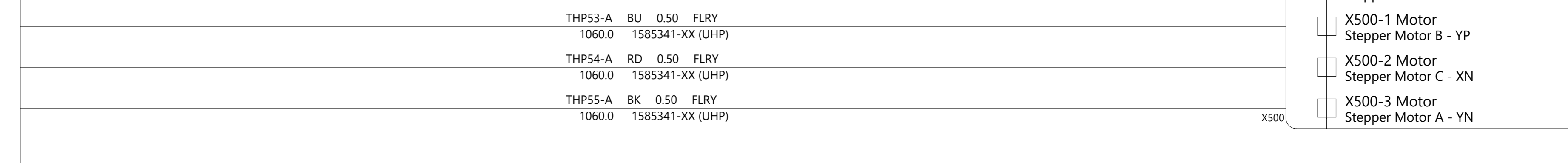
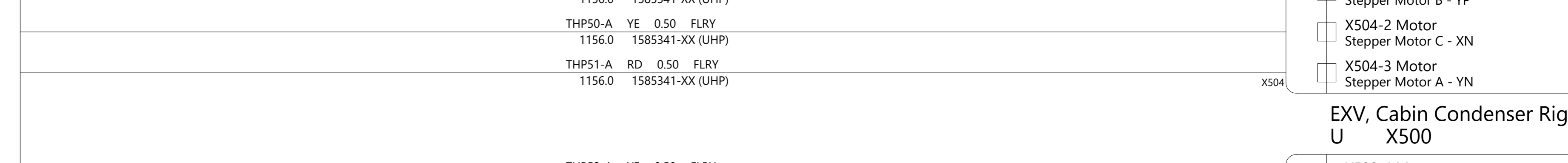
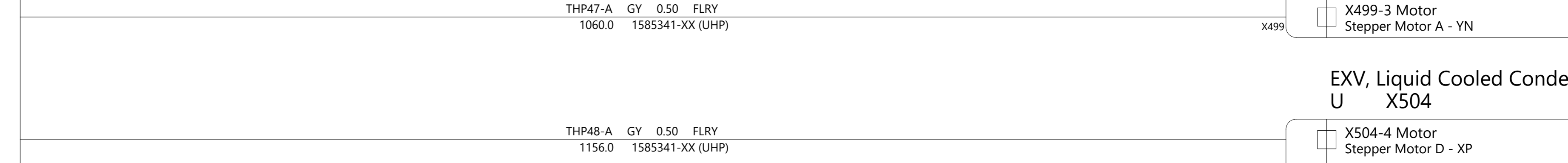
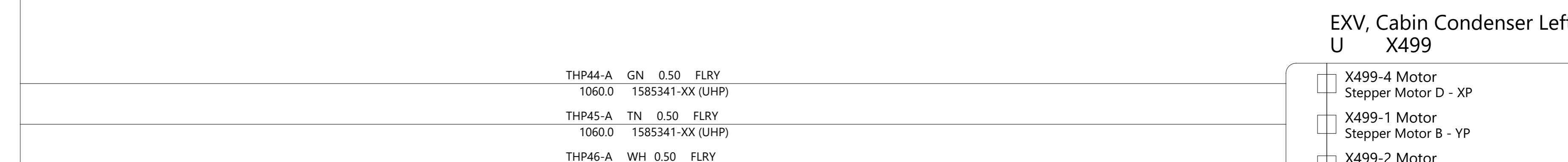
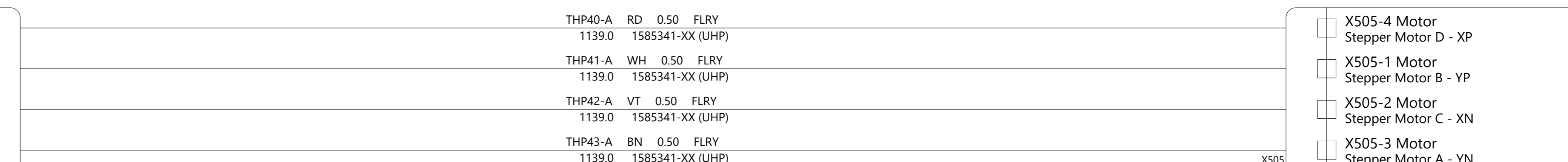
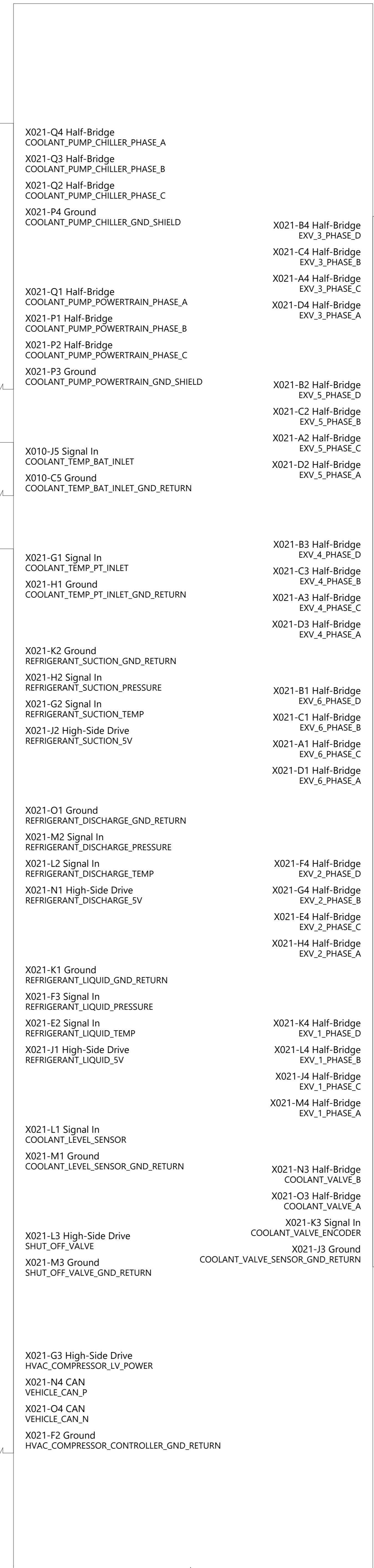

THE INFORMATION CONTAINED HEREIN IS DEEMED TO BE CONFIDENTIAL, PROPRIETARY, AND A TRADE SECRET OF TESLA MOTORS. THIS INFORMATION MAY NOT BE USED, REPRODUCED, OR DISCLOSED AS THE DIRECT OR INDIRECT BASIS FOR THE DEVELOPMENT, MANUFACTURE, OR SALE OF PROCESSES OR PRODUCTS WITHOUT THE EXPRESSED WRITTEN CONSENT OF TESLA MOTORS.

DRAWN	CHECKED	APPROVED
MATERIAL AS SPECIFIED		SCALE NONE
PART NAME HVAC: Thermal Bar		
PART NUMBER	REV	SHEET
	1	39 OF 61
		SIZE A0

**Body Controller Right**  
B,W,J,D X051 X052 X054 X060A/B X062 X053A/B X055 X056 X058 X059

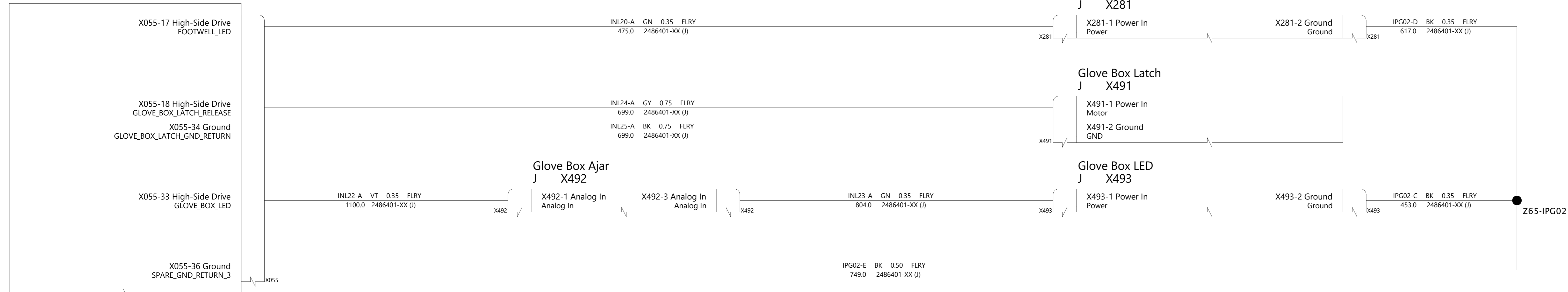

**Body Controller Left**  
A,W,J,D X030A/B X031 X032 X034 X038A/B X039 X037 X033A/B X035 X036

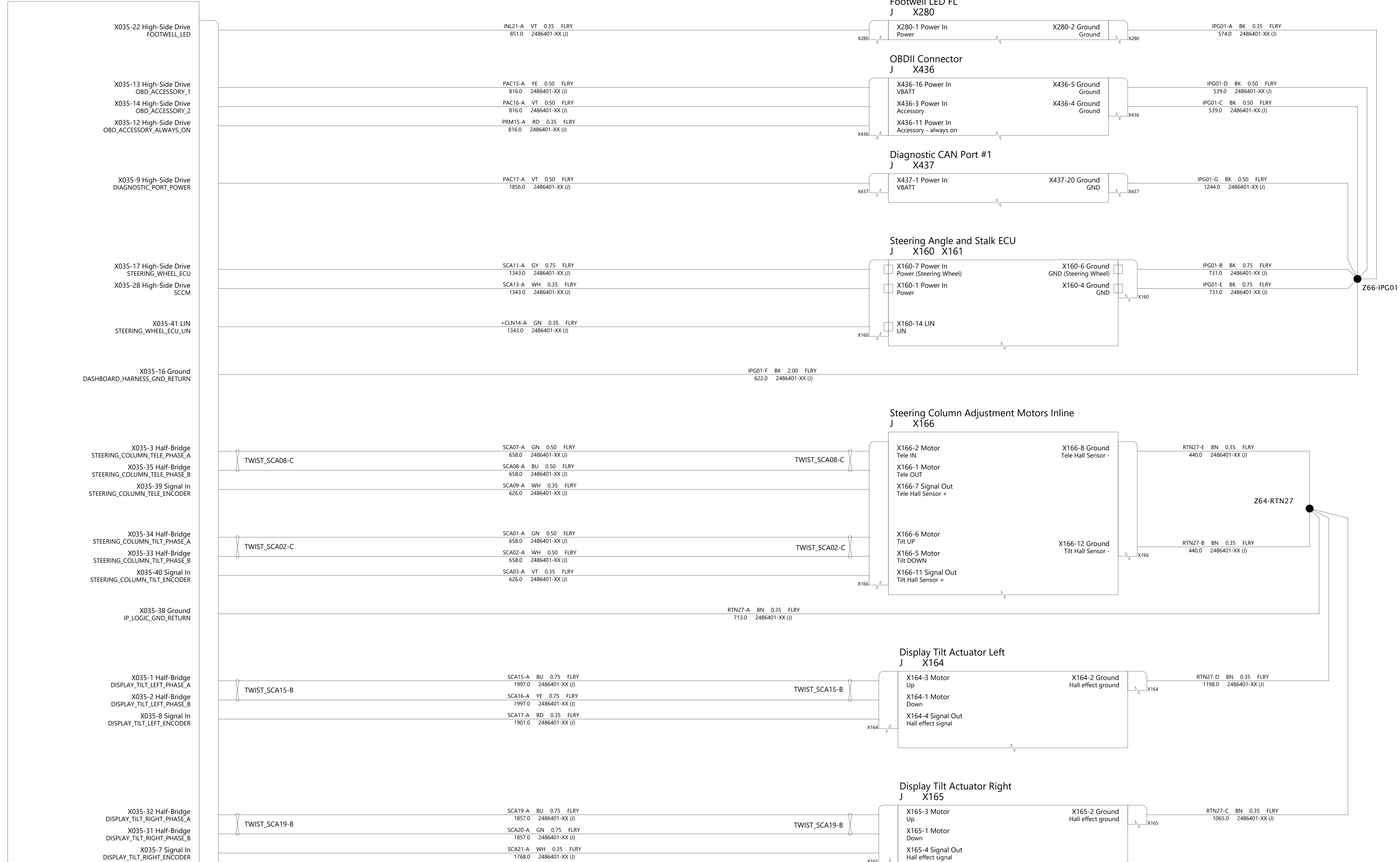

THE INFORMATION CONTAINED HEREIN IS DEEMED TO BE CONFIDENTIAL, PROPRIETARY, AND A TRADE SECRET OF TESLA MOTORS. THIS INFORMATION MAY NOT BE USED, REPRODUCED, OR DISCLOSED AS THE DIRECT OR INDIRECT BASIS FOR THE DEVELOPMENT, MANUFACTURE, OR SALE OF PROCESSES OR PRODUCTS WITHOUT THE EXPRESSED WRITTEN CONSENT OF TESLA MOTORS.

DRAWN	CHECKED	APPROVED
MATERIAL AS SPECIFIED	FINISHING AS SPECIFIED	SCALE NONE
PART NAME Instrumental Panel		
PART NUMBER	REV 1	SHEET 40 OF 61
		SIZE A0



**Body Controller Left  
A,W,J,D**

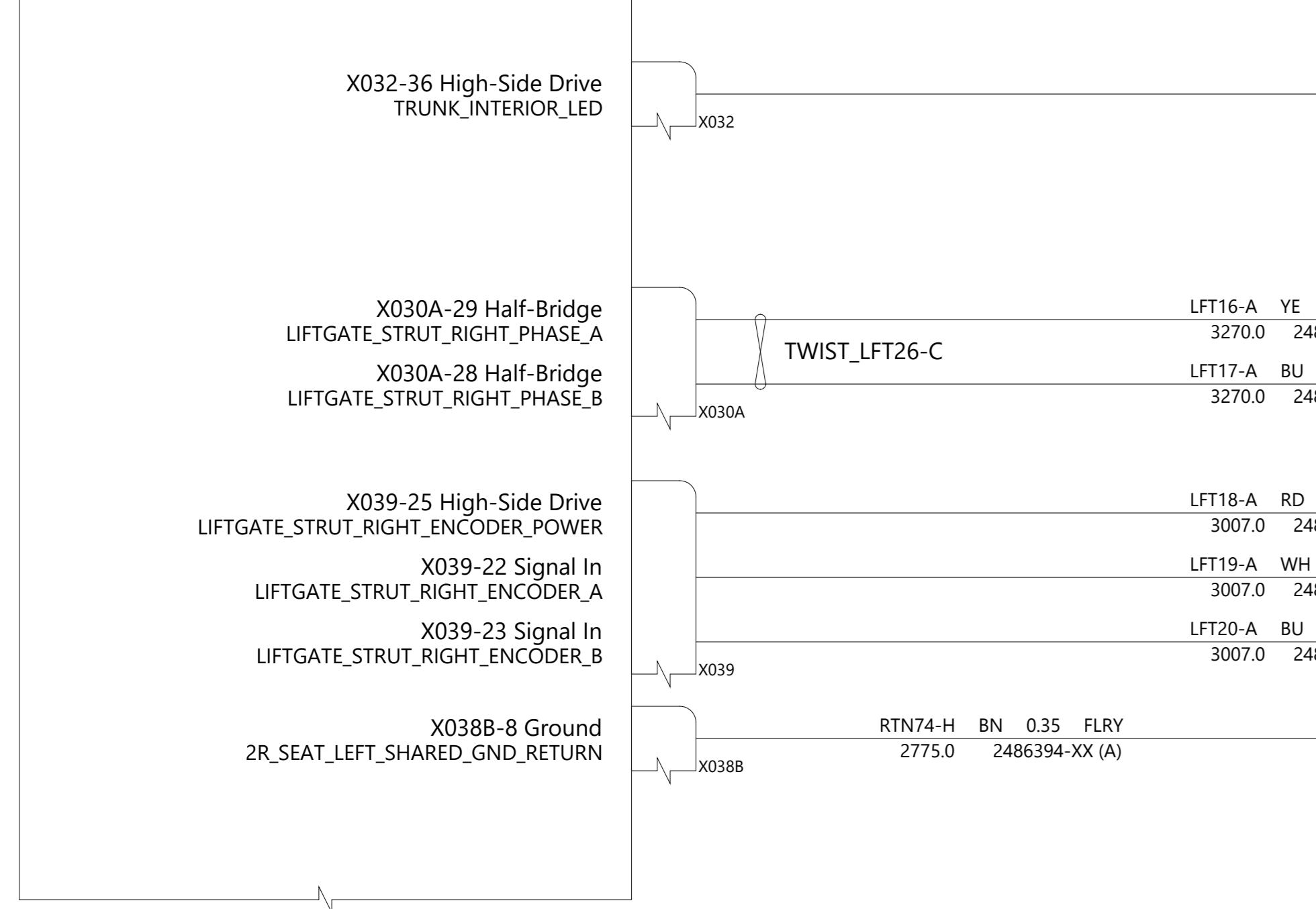

**Trunk Interior LED RL  
A X290**

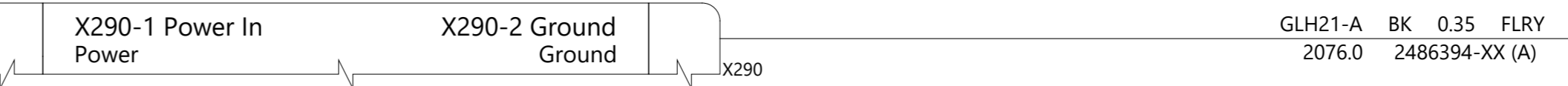

**Power Liftgate Motor Right  
B X391**

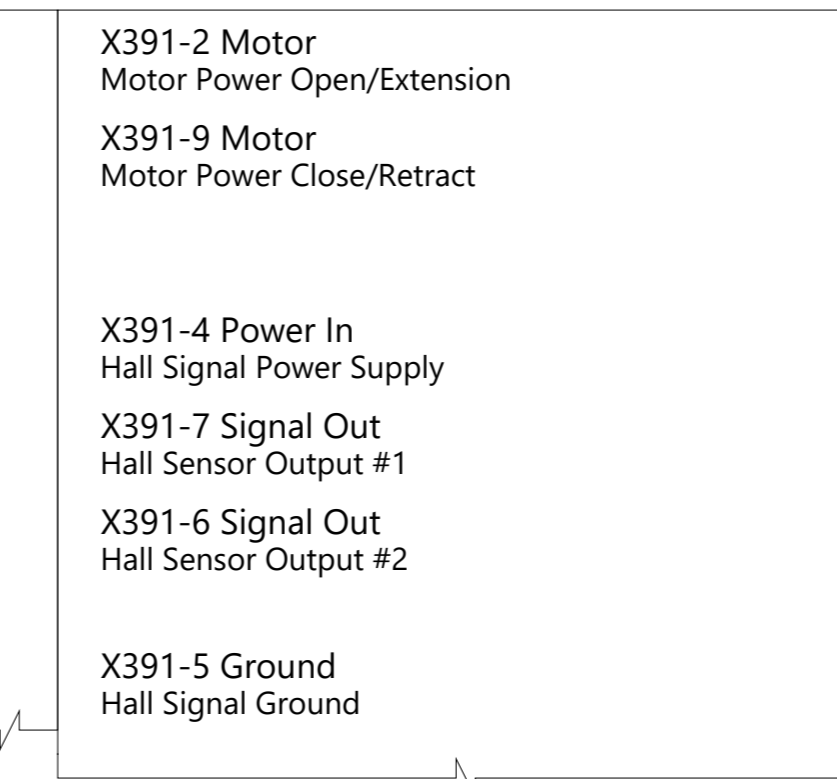

**Body Controller Right  
B,W,J,D**

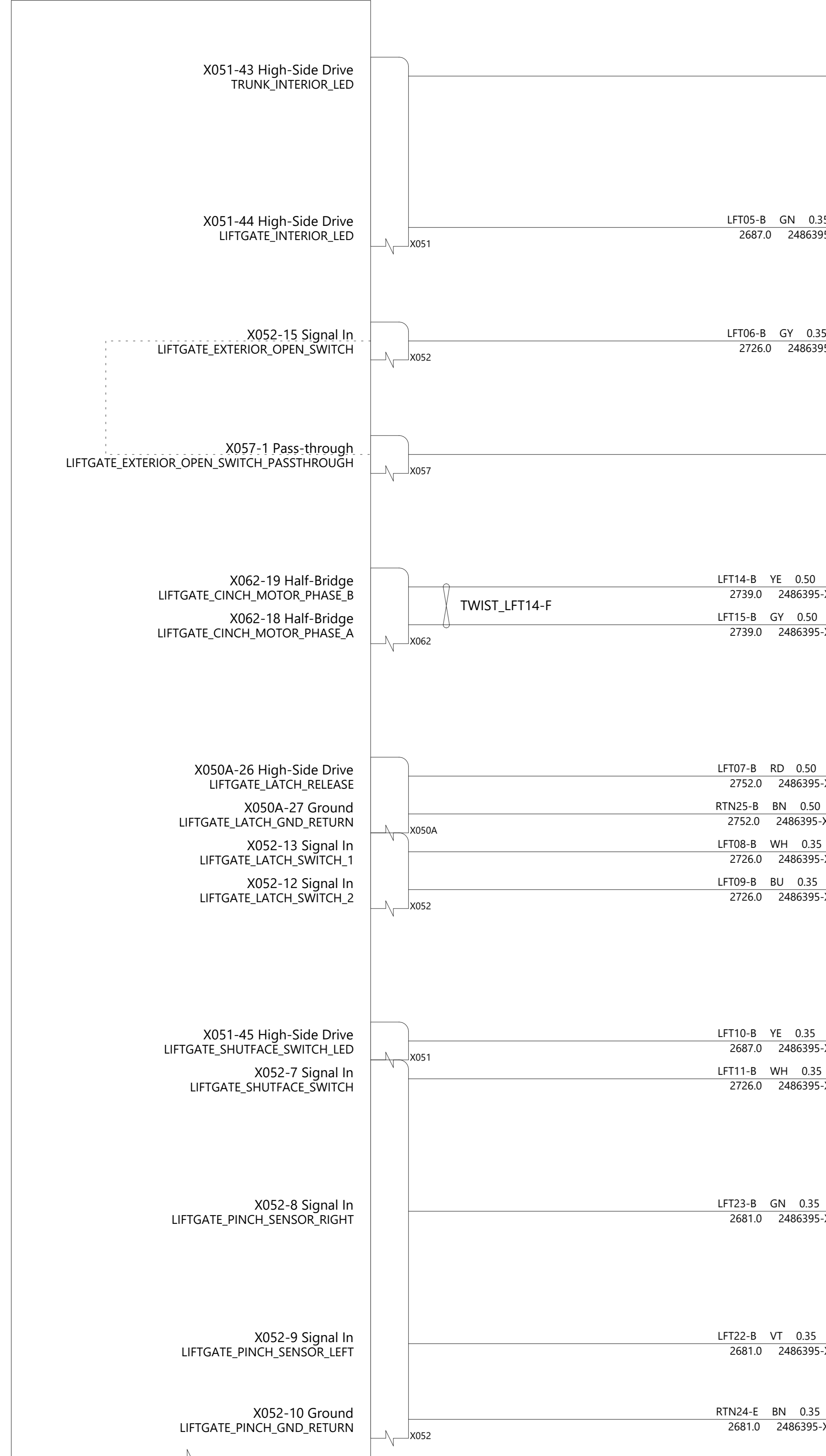

**Trunk Interior LED RR  
B X291**

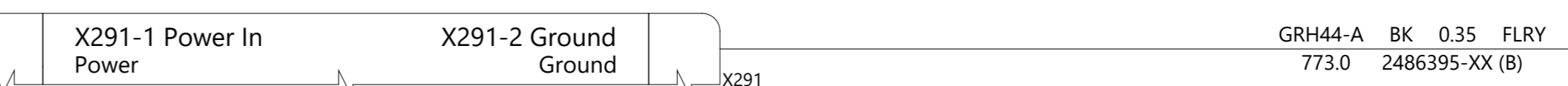

**Liftgate Interior LED  
T X292**



**Liftgate Exterior Open Switch  
T X387**

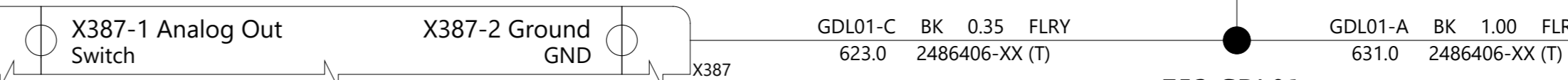

**Body Controller Battery  
W X025 X022 X023 X024 X026**



**Liftgate Cinching Latch  
T X396**

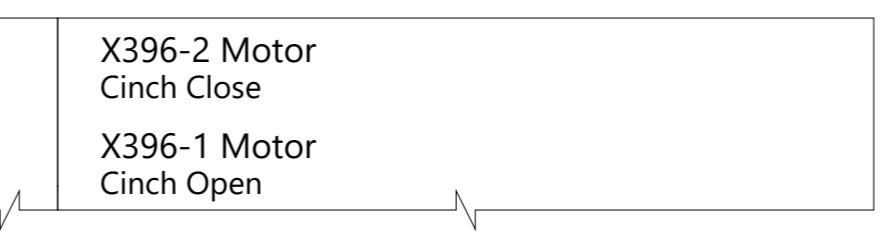

**Liftgate Latch  
T X385**

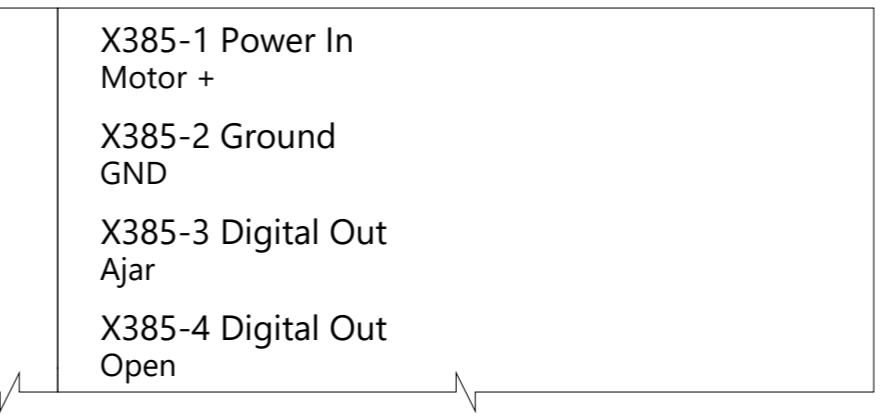

**Liftgate Shutface Close Switch  
T X394**

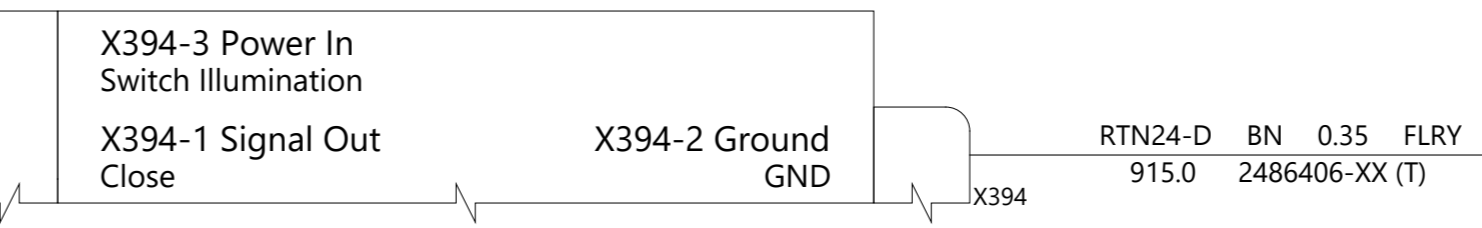

**Liftgate Anti Pinch Sensor Right  
T X390**



**Liftgate Anti Pinch Sensor Left  
T X389**

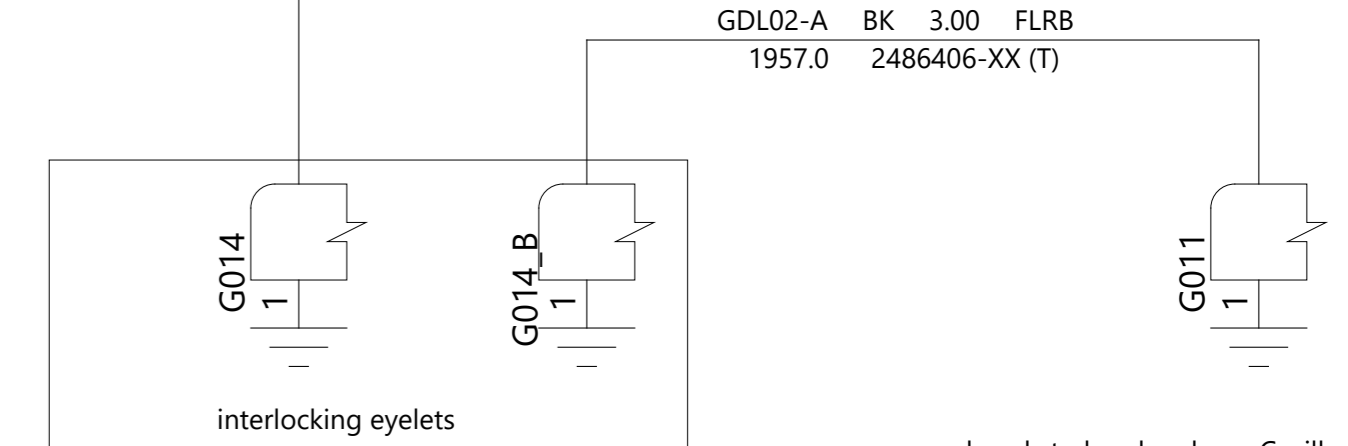

THE INFORMATION CONTAINED HEREIN IS DEEMED TO BE CONFIDENTIAL, PROPRIETARY, AND A TRADE SECRET OF TESLA MOTORS. THIS INFORMATION MAY NOT BE USED, REPRODUCED, OR DISCLOSED AS THE DIRECT OR INDIRECT BASIS FOR THE DEVELOPMENT, MANUFACTURE, OR SALE OF PROCESSES OR PRODUCTS WITHOUT THE EXPRESSED WRITTEN CONSENT OF TESLA MOTORS.

DRAWN	CHECKED	APPROVED
MATERIAL AS SPECIFIED	FINISHING AS SPECIFIED	SCALE NONE
PART NAME Liftgate Actuators/Sensors		
PART NUMBER	REV	SHEET
	1	41 OF 61
		SIZE A0

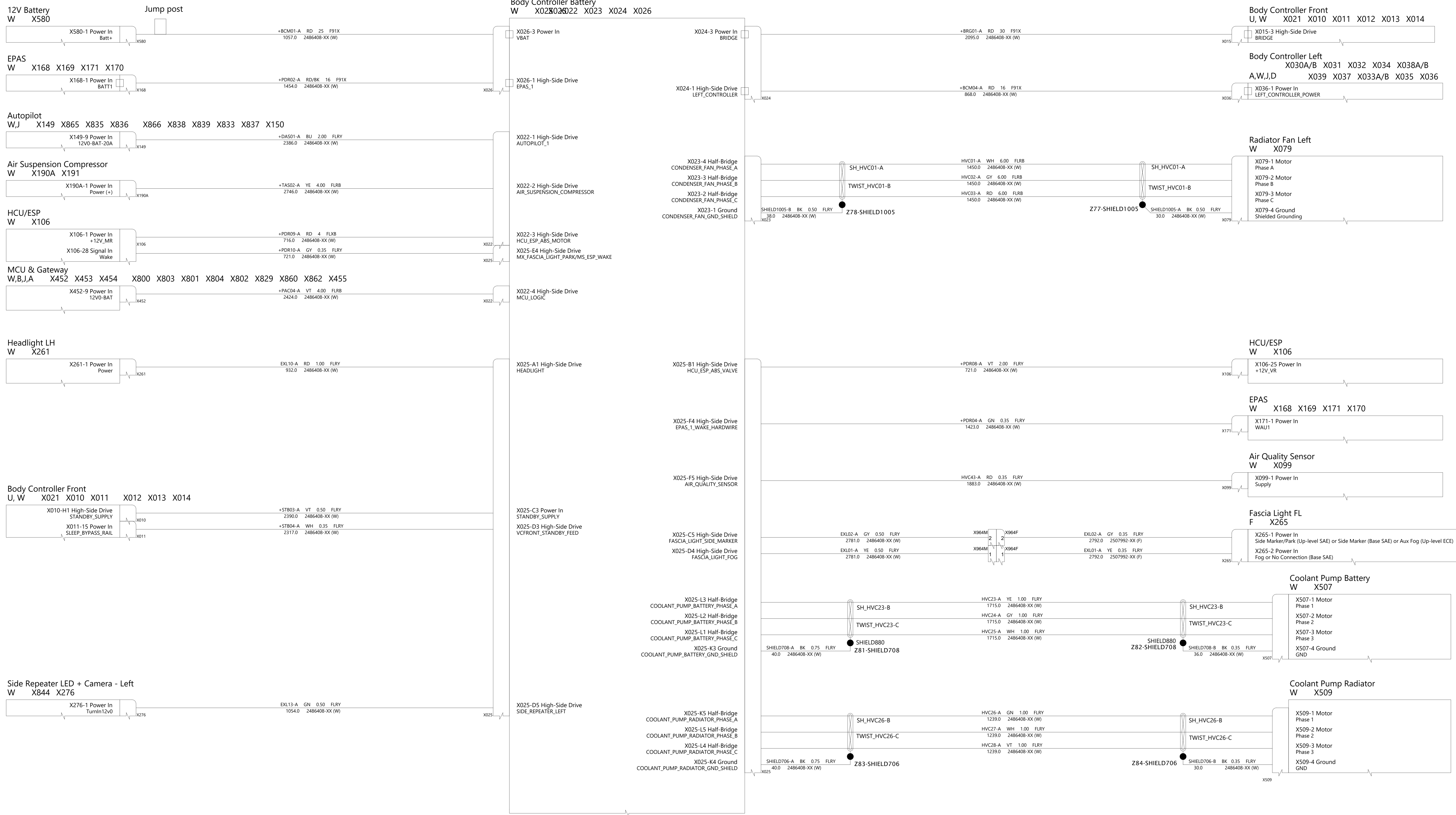

**TESLA**

THE INFORMATION CONTAINED HEREIN IS DEEMED TO BE CONFIDENTIAL, PROPRIETARY, AND A TRADE SECRET OF TESLA MOTORS. THIS INFORMATION MAY NOT BE USED, REPRODUCED, OR DISCLOSED AS THE DIRECT OR INDIRECT BASIS FOR THE DEVELOPMENT, MANUFACTURE, OR SALE OF PROCESSES OR PRODUCTS WITHOUT THE EXPRESSED WRITTEN CONSENT OF TESLA MOTORS.

DRAWN	CHECKED	APPROVED

MATERIAL AS SPECIFIED	FINISHING AS SPECIFIED	SCALE NONE

PART NAME  
**Power Distribution, Battery Controller**

PART NUMBER	REV	SHEET	SIZE
	1	42 OF 61	A0

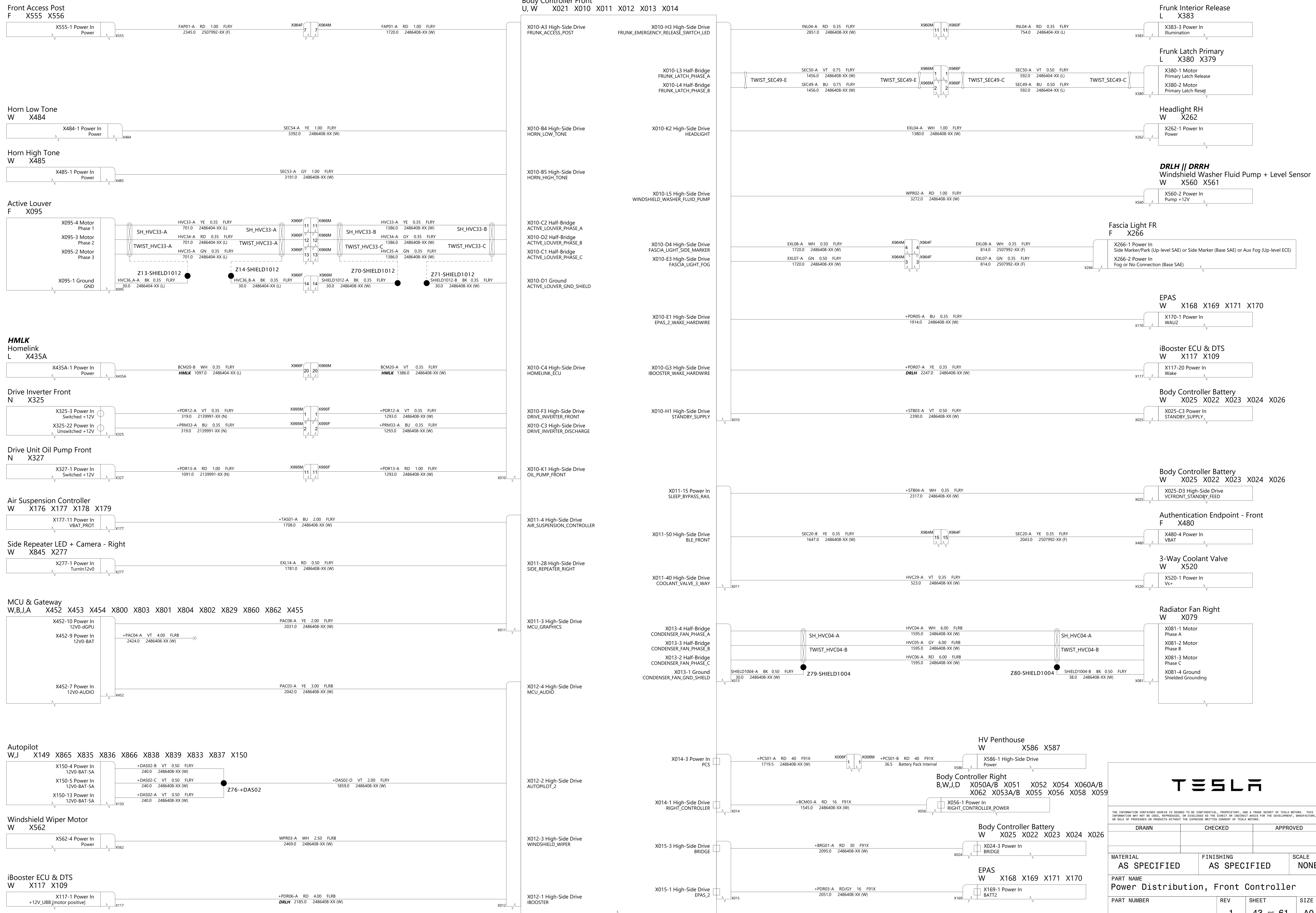

<b>TESLA</b>			
THE INFORMATION CONTAINED HEREIN IS DEEMED TO BE CONFIDENTIAL, PROPRIETARY, AND A TRADE SECRET OF TESLA MOTORS. THIS INFORMATION MAY NOT BE USED, REPRODUCED, OR DISCLOSED AS THE DIRECT OR INDIRECT BASIS FOR THE DEVELOPMENT, MANUFACTURE, OR SALE OF PROCESSES OR PRODUCTS WITHOUT THE EXPRESSED WRITTEN CONSENT OF TESLA MOTORS.			
DRAWN	CHECKED	APPROVED	
MATERIAL AS SPECIFIED	FINISHING AS SPECIFIED	SCALE NONE	
PART NAME <b>Power Distribution, Front Controller</b>			
PART NUMBER	REV	SHEET	SIZE
	1	43 OF 61	A0

**DRLH || DRRH**  
Accelerator Pedal  
A X252

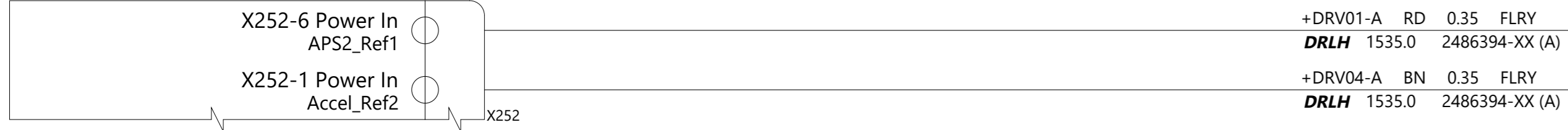

Center Console Light Pipe FR  
C X1123

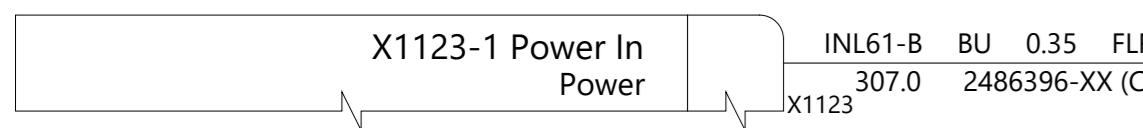

Center Console Light Pipe FL  
C X1122

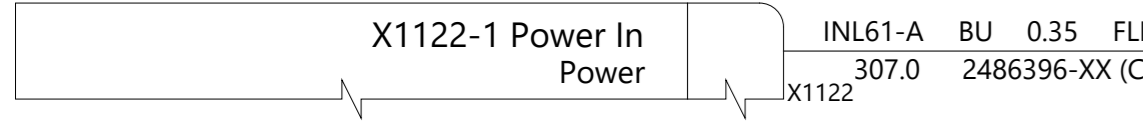

Center Console Light Pipe Rear  
C X1120

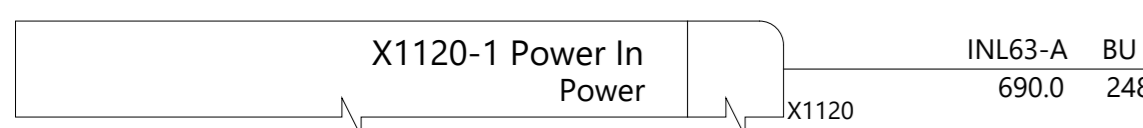

Center Console Center Footwell  
C X1124



USB Ports Front  
C X1131 X881

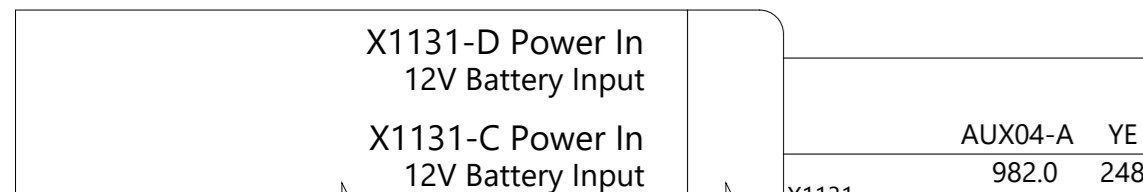

USB Ports Rear  
C X1132

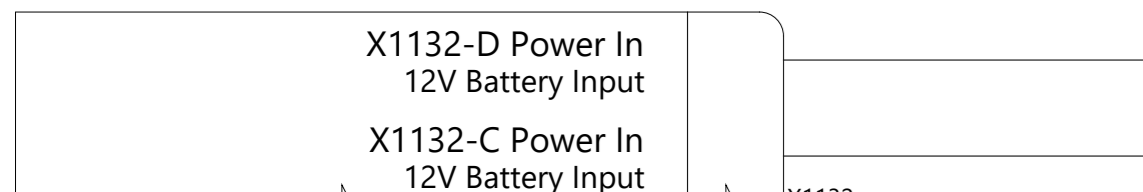

Inductive Charger Front  
C X1133

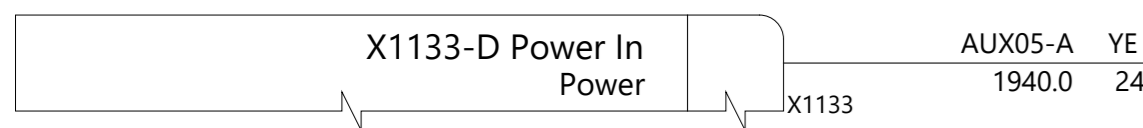

12V Power Socket  
C X1130

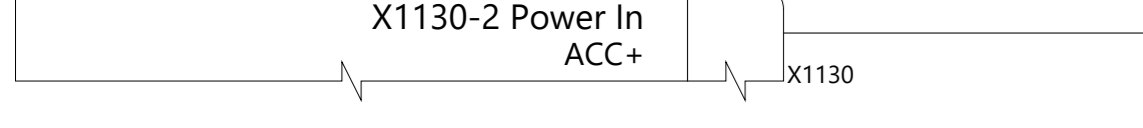

Map Light RL  
K X286

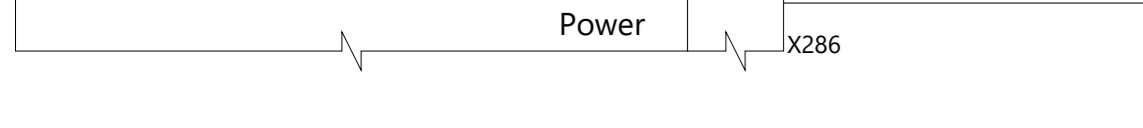

Vanity LED + Switch Left  
K X296

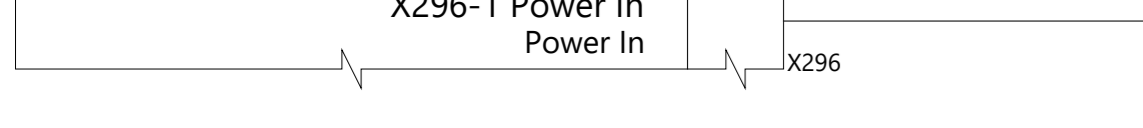

Hazard + PRND Switch  
C X1138

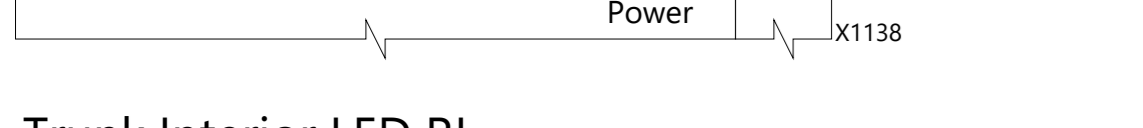

Trunk Interior LED RL  
A X290



Body Controller Left  
A,W,J,D X031 X032 X034 X038A/B X039 X037 X033A/B X035 X036

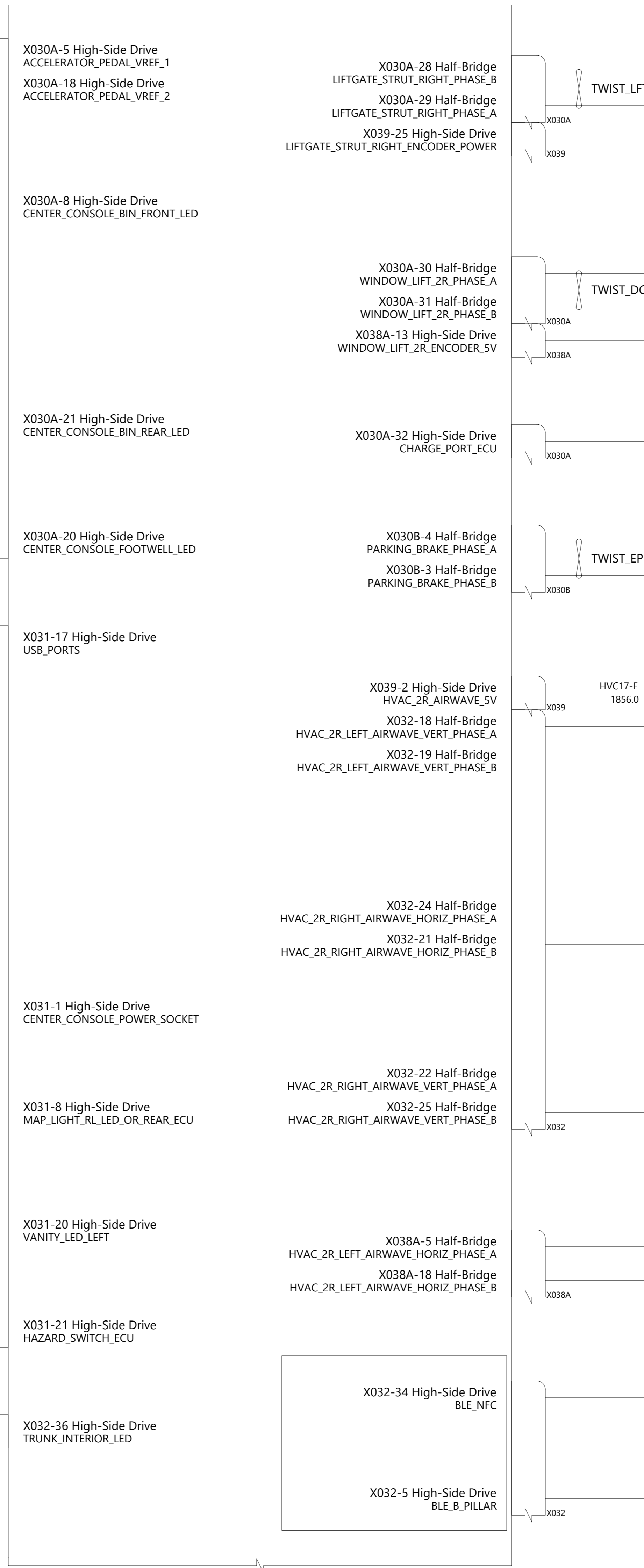

Power Liftgate Motor Right  
B X391

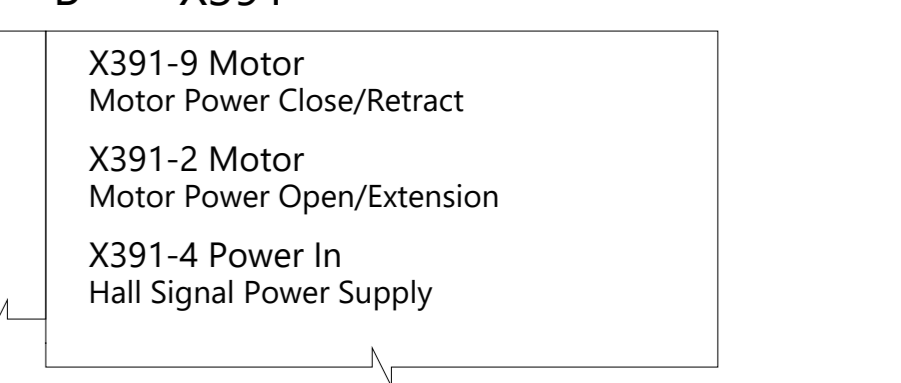

Window Motor RL  
R X366

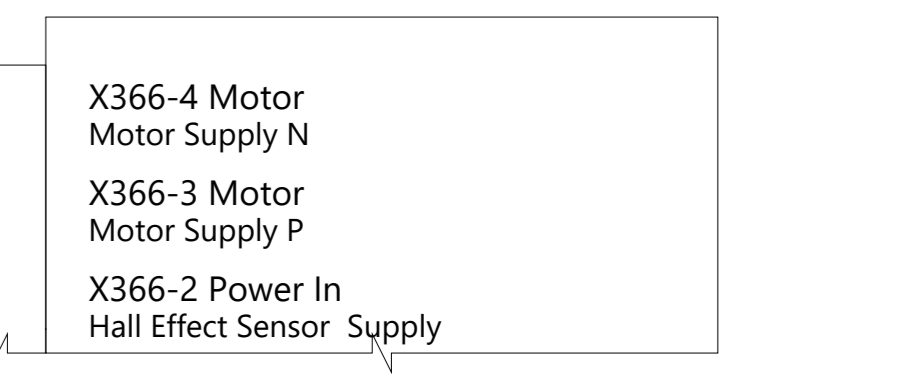

Charge Port ECU  
A X049 X048 X047



Park Brake Caliper LH  
XL X103A

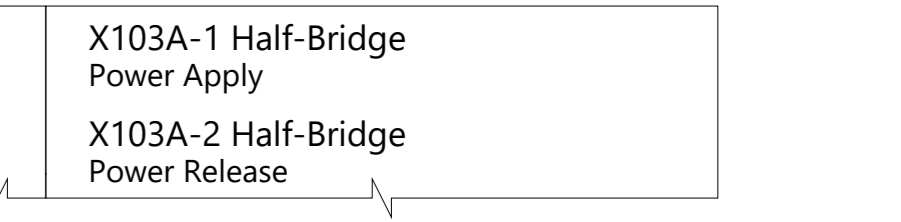

Vane Actuator - 2nd Row Left Vertical  
C X1140

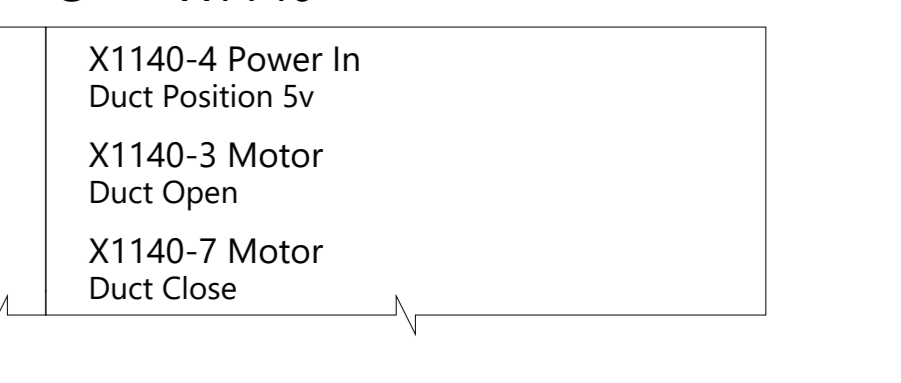

Vane Actuator - 2nd Row Right Horizontal  
C X1146

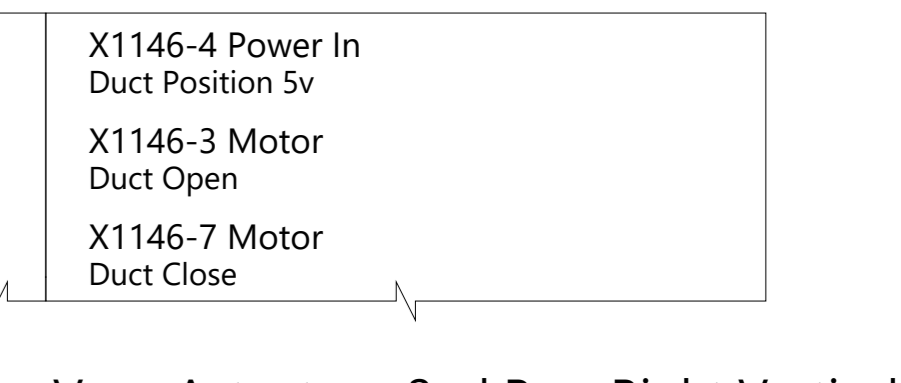

Vane Actuator - 2nd Row Right Vertical  
C X1145

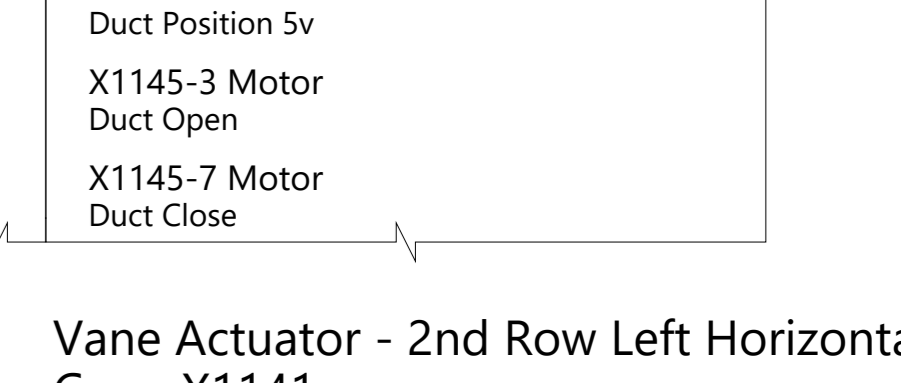

Vane Actuator - 2nd Row Left Horizontal  
C X1141

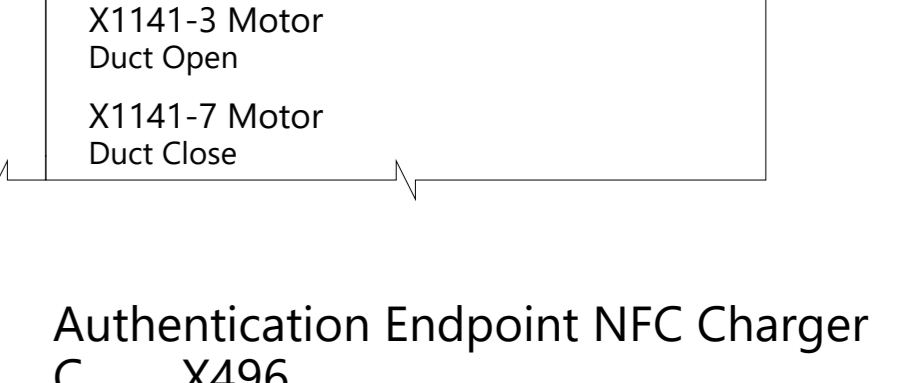

Authentication Endpoint NFC Charger  
C X496



Authentication Endpoint B-Pillar LH  
A X478



THE INFORMATION CONTAINED HEREIN IS DEEMED TO BE CONFIDENTIAL, PROPRIETARY, AND A TRADE SECRET OF TESLA MOTORS. THIS INFORMATION MAY NOT BE USED, REPRODUCED, OR DISCLOSED AS THE DIRECT OR INDIRECT BASIS FOR THE DEVELOPMENT, MANUFACTURE, OR SALE OF PROCESSES OR PRODUCTS WITHOUT THE EXPRESSED WRITTEN CONSENT OF TESLA MOTORS.

DRAWN	CHECKED	APPROVED
MATERIAL AS SPECIFIED	FINISHING AS SPECIFIED	SCALE NONE
PART NAME Power Distribution, Left Controller 1/3		
PART NUMBER	REV	SHEET
	1	44 OF 61
		SIZE A0

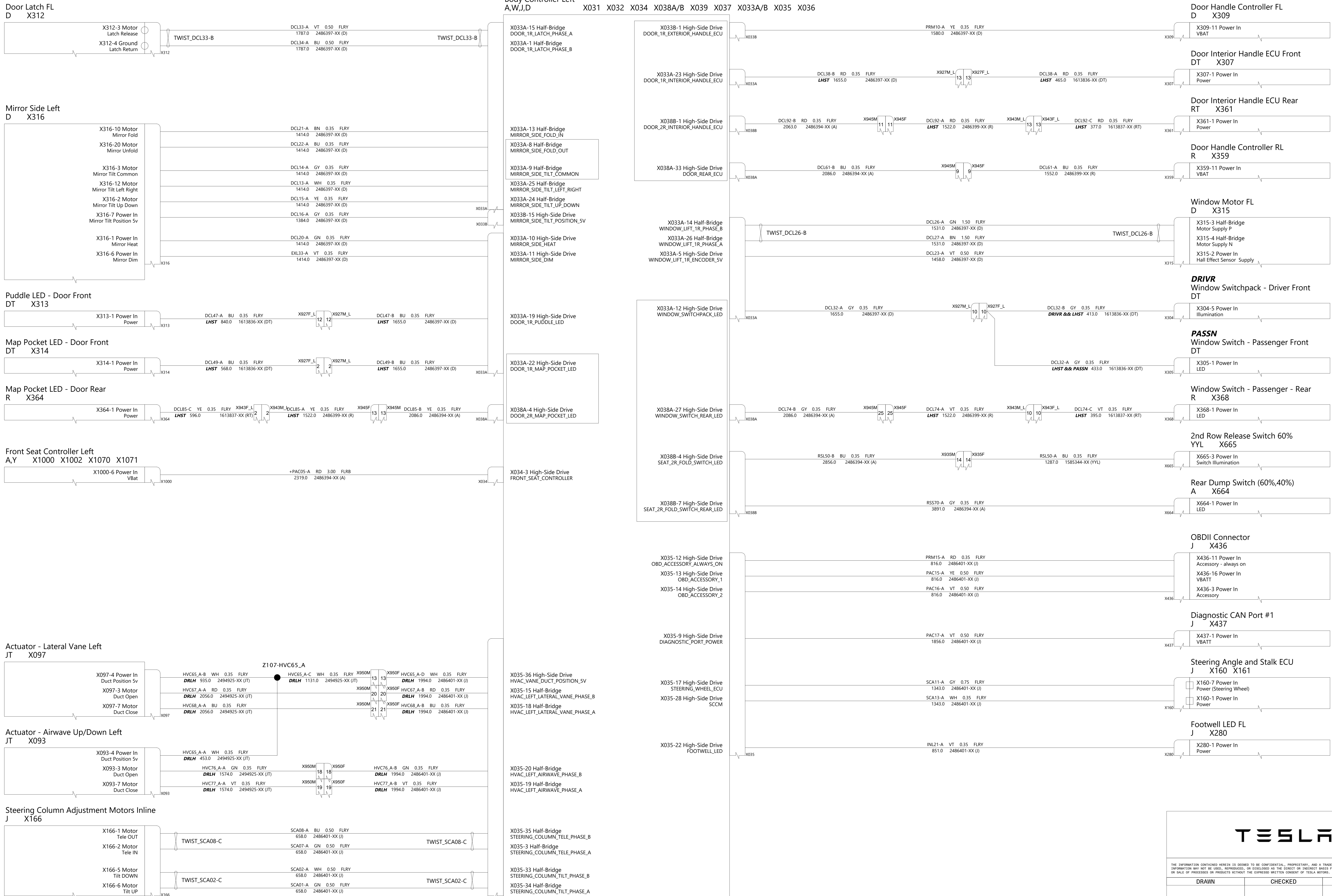

THE INFORMATION CONTAINED HEREIN IS DEEMED TO BE CONFIDENTIAL, PROPRIETARY, AND A TRADE SECRET OF TESLA MOTORS. THIS INFORMATION MAY NOT BE USED, REPRODUCED, OR DISCLOSED AS THE DIRECT OR INDIRECT BASIS FOR THE DEVELOPMENT, MANUFACTURE, OR SALE OF PROCESSES OR PRODUCTS WITHOUT THE EXPRESSED WRITTEN CONSENT OF TESLA MOTORS.

DRAWN	CHECKED	APPROVED
MATERIAL AS SPECIFIED	FINISHING AS SPECIFIED	SCALE NONE
PART NAME Power Distribution, Left Controller 2/3		
PART NUMBER	REV	SHEET
	1	45 OF 61
		SIZE A0

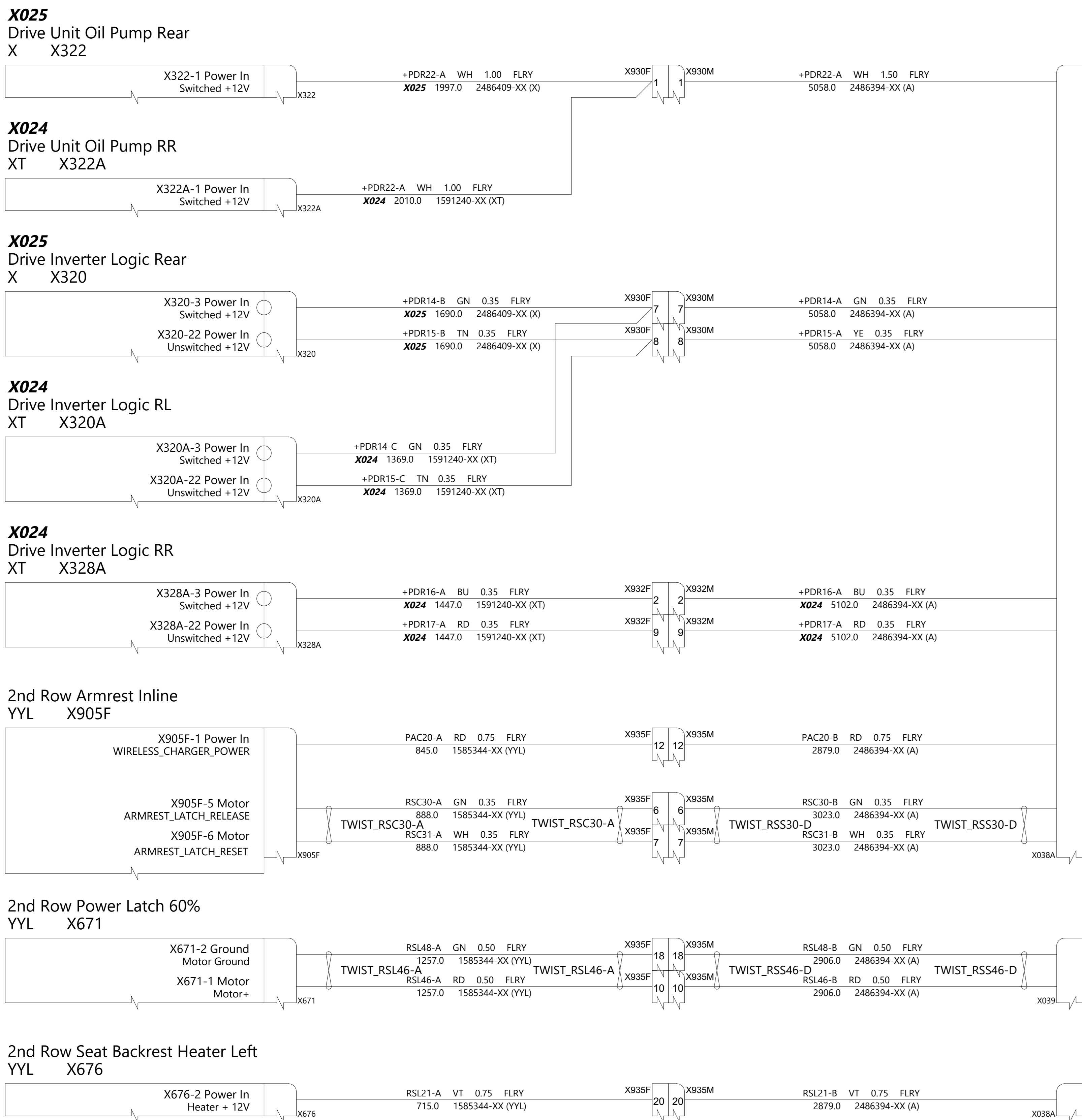

**Body Controller Left**  
A,W,I,D X031 X032 X034 X038A/B X039 X037 X033A/B X035 X036

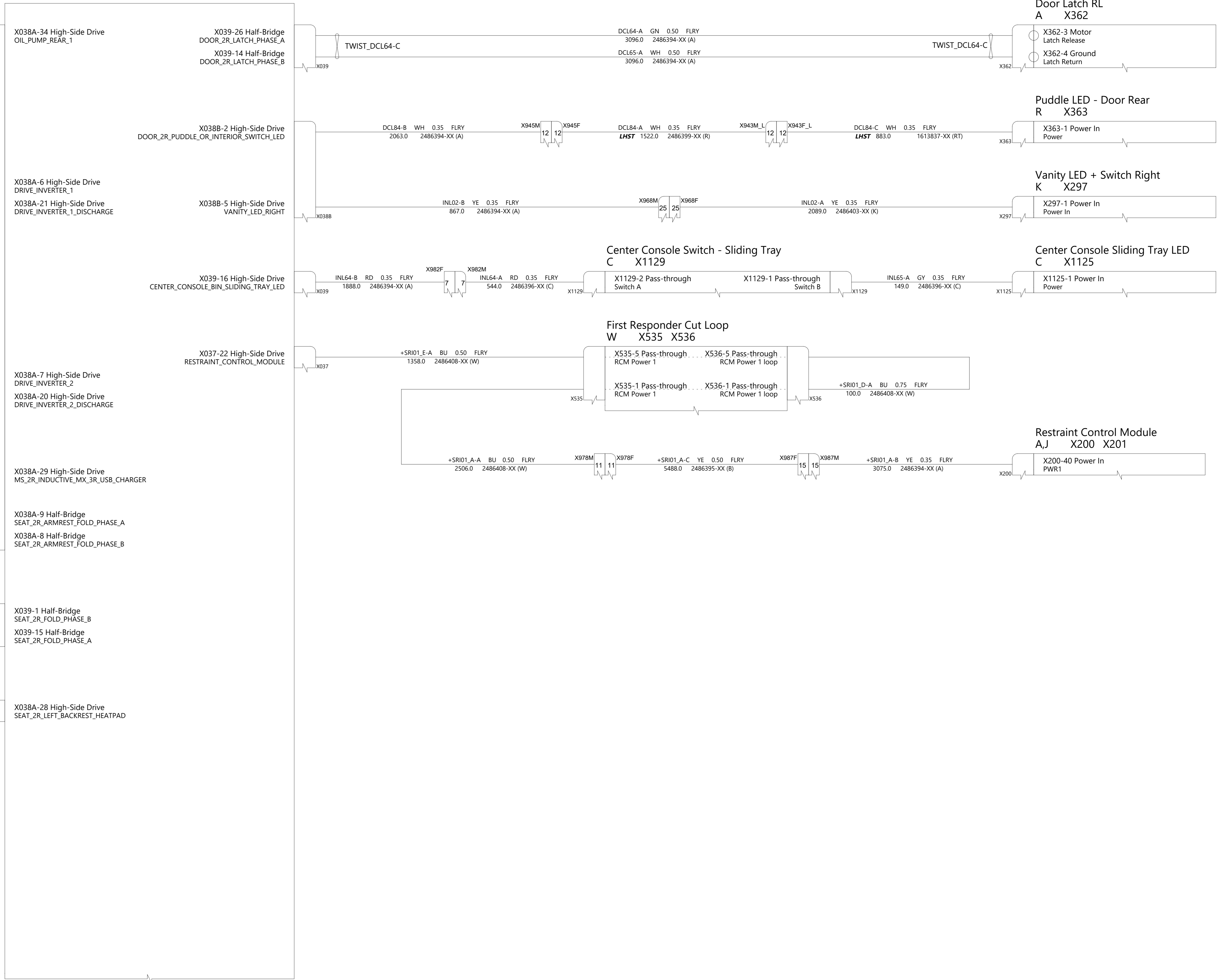

THE INFORMATION CONTAINED HEREIN IS DEEMED TO BE CONFIDENTIAL, PROPRIETARY, AND A TRADE SECRET OF TESLA MOTORS. THIS INFORMATION MAY NOT BE USED, REPRODUCED, OR DISCLOSED AS THE DIRECT OR INDIRECT BASIS FOR THE DEVELOPMENT, MANUFACTURE, OR SALE OF PROCESSES OR PRODUCTS WITHOUT THE EXPRESSED WRITTEN CONSENT OF TESLA MOTORS.

DRAWN	CHECKED	APPROVED
MATERIAL AS SPECIFIED	FINISHING AS SPECIFIED	SCALE NONE
PART NAME Power Distribution, Left Controller 3/3		
PART NUMBER	REV	SHEET
	1	46 of 61
		SIZE A0

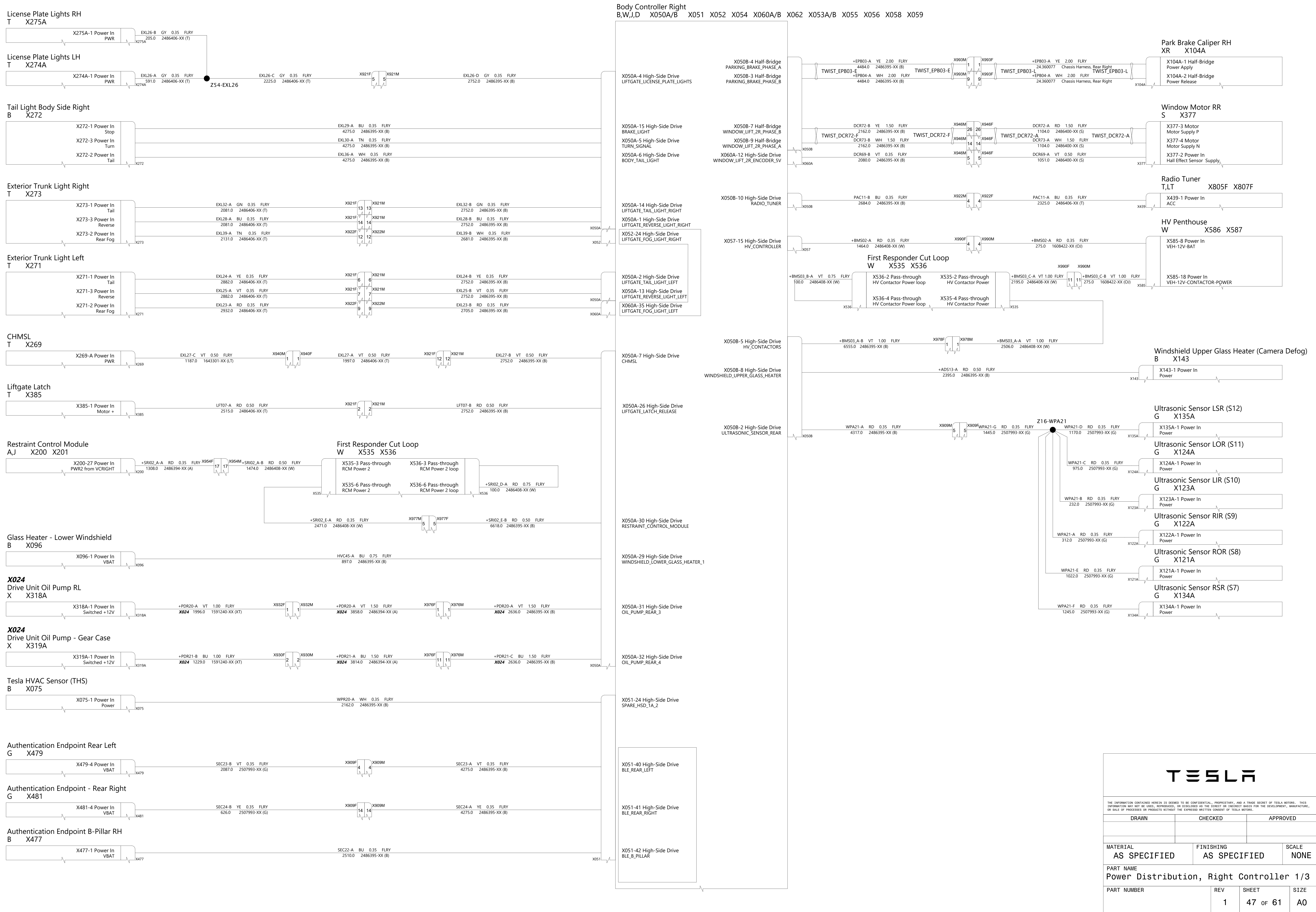

<b>TESLA</b>			
THE INFORMATION CONTAINED HEREIN IS DEEMED TO BE CONFIDENTIAL, PROPRIETARY, AND A TRADE SECRET OF TESLA MOTORS. THIS INFORMATION MAY NOT BE USED, REPRODUCED, OR DISCLOSED AS THE DIRECT OR INDIRECT BASIS FOR THE DEVELOPMENT, MANUFACTURE, OR SALE OF PROCESSES OR PRODUCTS WITHOUT THE EXPRESSED WRITTEN CONSENT OF TESLA MOTORS.			
DRAWN	CHECKED	APPROVED	
MATERIAL AS SPECIFIED	FINISHING AS SPECIFIED	SCALE NONE	
PART NAME <b>Power Distribution, Right Controller 1/3</b>			
PART NUMBER	REV	SHEET	SIZE
	1	47 OF 61	A0

Body Controller Right  
B,W,J,D X050A/B X051 X052 X054 X060A/B X062 X053A/B X055 X056 X058 X059

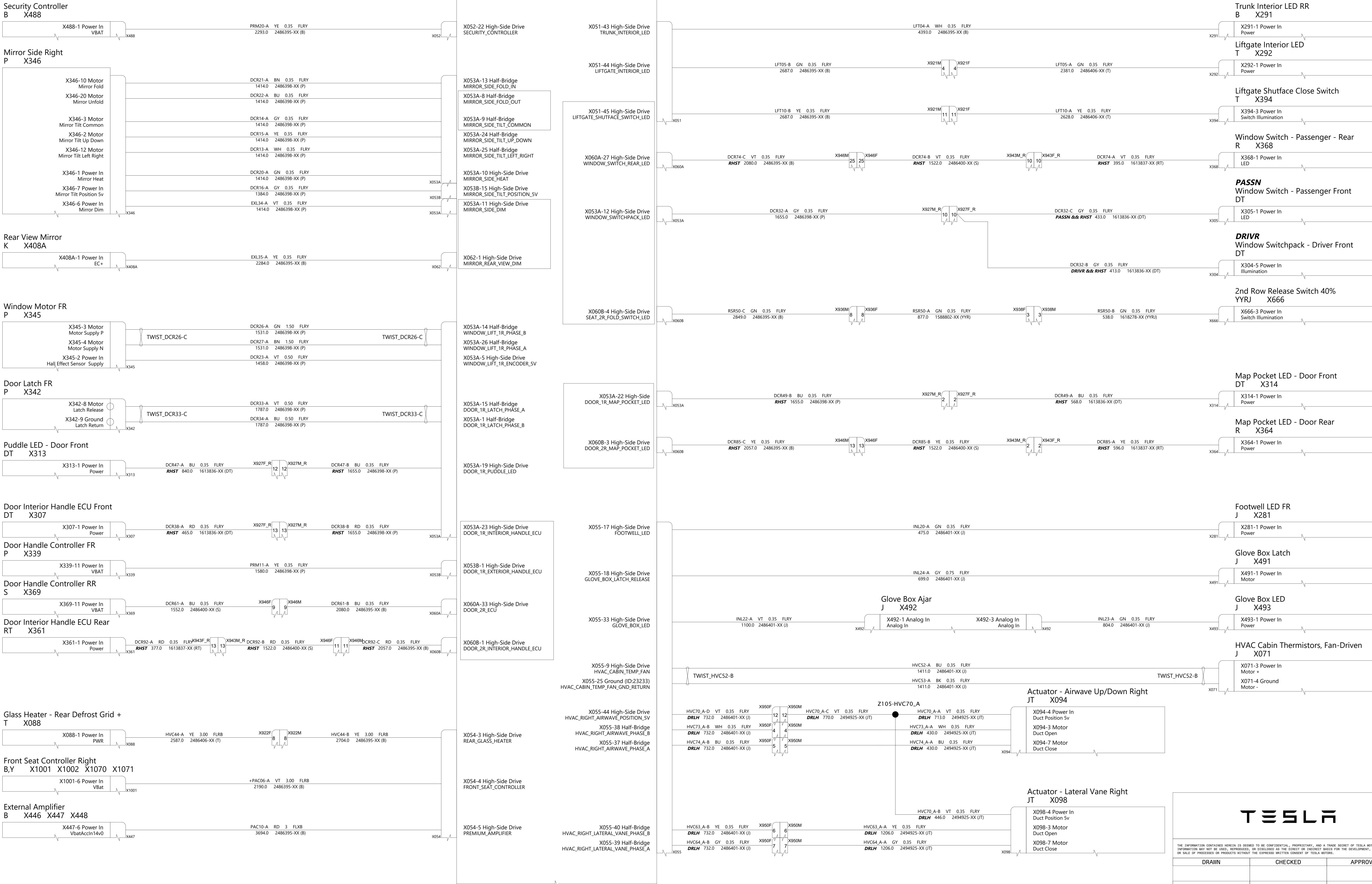

<b>TESLA</b>			
THE INFORMATION CONTAINED HEREIN IS DEEMED TO BE CONFIDENTIAL, PROPRIETARY, AND A TRADE SECRET OF TESLA MOTORS. THIS INFORMATION MAY NOT BE USED, REPRODUCED, OR DISCLOSED AS THE DIRECT OR INDIRECT BASIS FOR THE DEVELOPMENT, MANUFACTURE, OR SALE OF PROCEDES OR PRODUCTS WITHOUT THE EXPRESSED WRITTEN CONSENT OF TESLA MOTORS.			
DRAWN	CHECKED	APPROVED	
MATERIAL AS SPECIFIED	FINISHING AS SPECIFIED	SCALE NONE	
PART NAME Power Distribution, Right Controller 2/3			
PART NUMBER	REV	SHEET	SIZE
	1	48 OF 61	A0



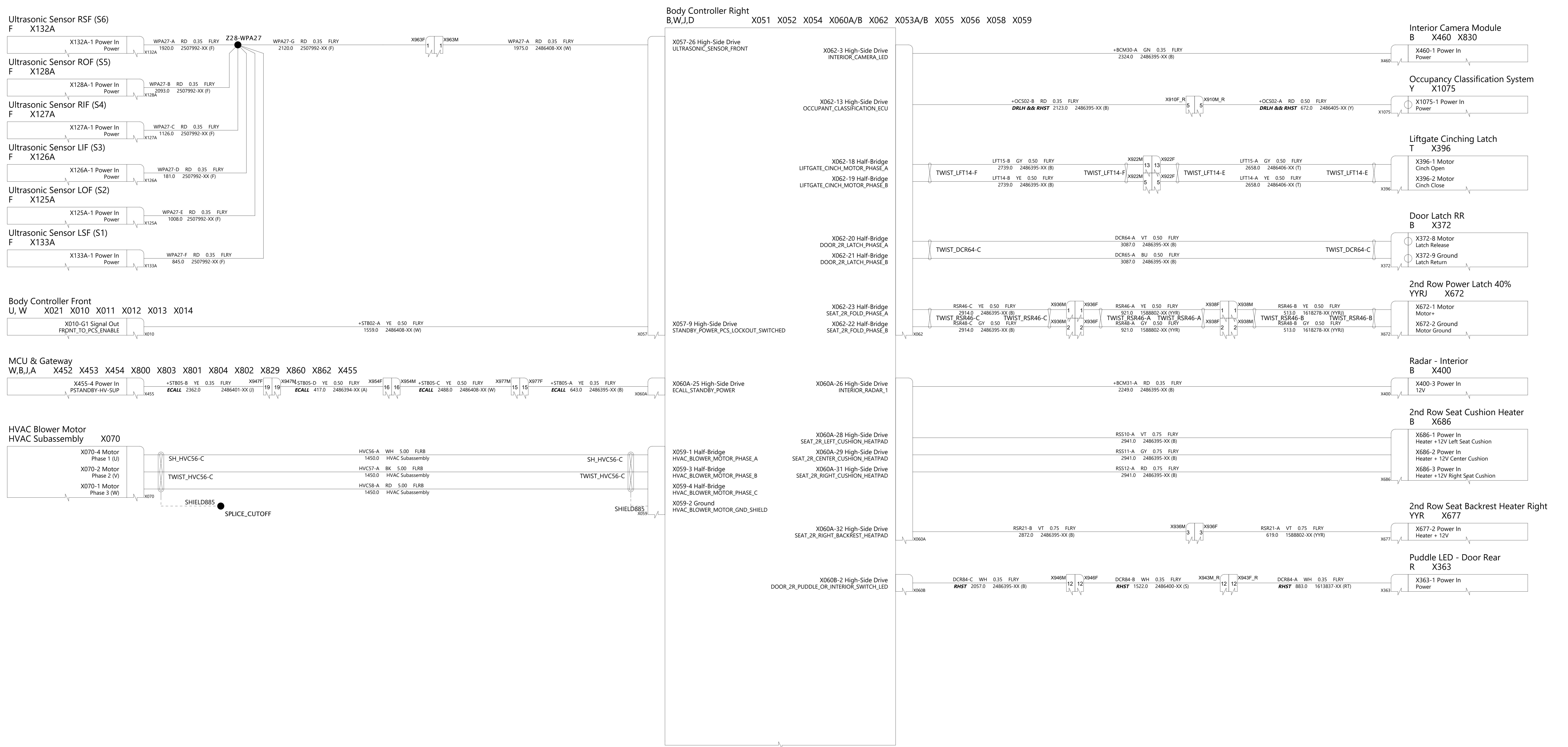

THE INFORMATION CONTAINED HEREIN IS DEEMED TO BE CONFIDENTIAL, PROPRIETARY, AND A TRADE SECRET OF TESLA MOTORS. THIS INFORMATION MAY NOT BE USED, REPRODUCED, OR DISCLOSED AS THE DIRECT OR INDIRECT BASIS FOR THE DEVELOPMENT, MANUFACTURE, OR SALE OF PROCESSES OR PRODUCTS WITHOUT THE EXPRESSED WRITTEN CONSENT OF TESLA MOTORS.

DRAWN	CHECKED	APPROVED
MATERIAL AS SPECIFIED	FINISHING AS SPECIFIED	SCALE NONE
PART NAME Power Distribution, Right Controller 3/3		
PART NUMBER	REV	SHEET
	1	49 OF 61
		SIZE A0

Restraint Control Module  
A,J X200 X201

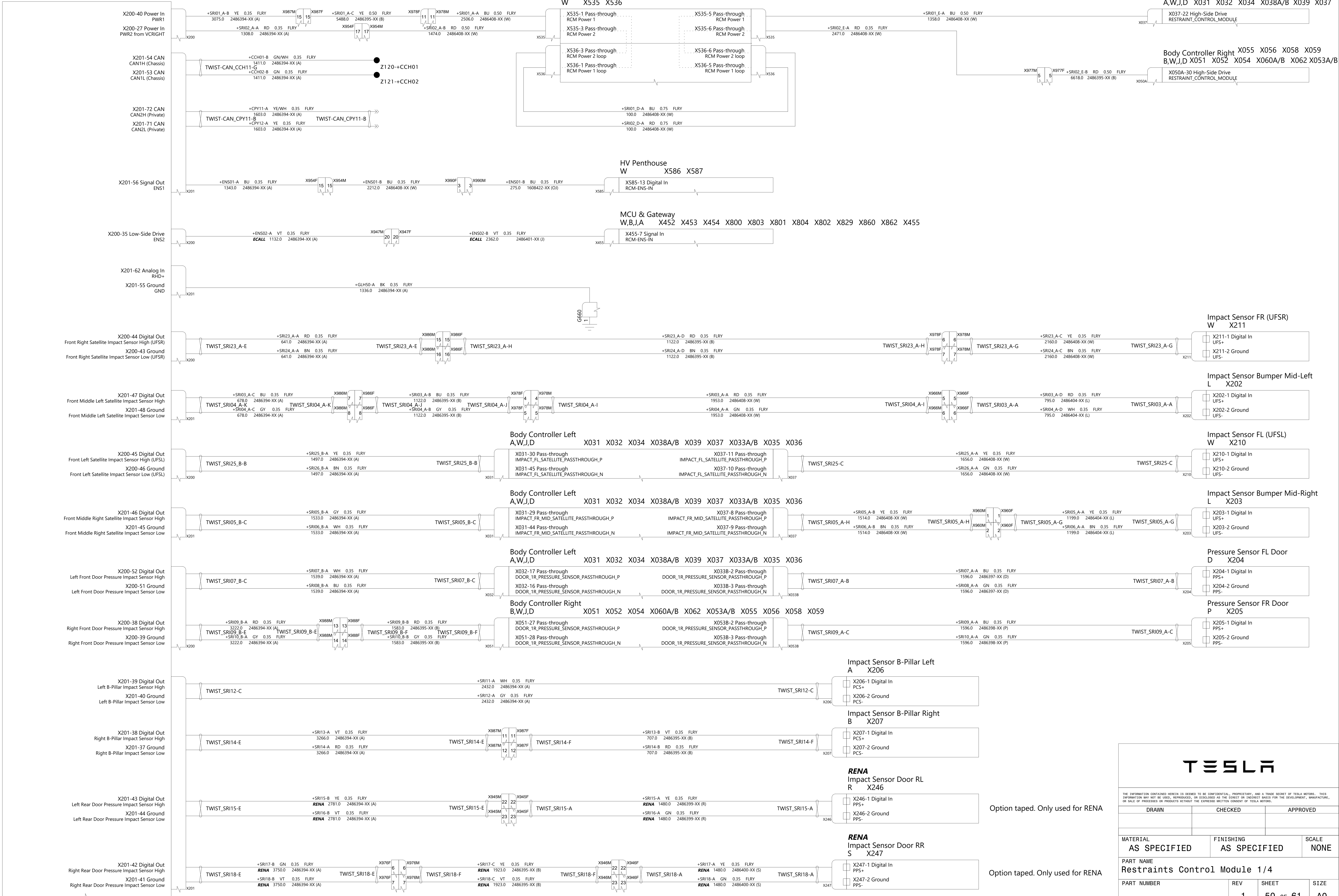

THE INFORMATION CONTAINED HEREIN IS DEEMED TO BE CONFIDENTIAL, PROPRIETARY, AND A TRADE SECRET OF TESLA MOTORS. THIS INFORMATION MAY NOT BE USED, REPRODUCED, OR DISCLOSED AS THE DIRECT OR INDIRECT BASIS FOR THE DEVELOPMENT, MANUFACTURE, OR SALE OF PROCESSES OR PRODUCTS WITHOUT THE EXPRESSED WRITTEN CONSENT OF TESLA MOTORS.

DRAWN	CHECKED	APPROVED
MATERIAL AS SPECIFIED	FINISHING AS SPECIFIED	SCALE NONE
PART NAME Restraints Control Module 1/4		
PART NUMBER	REV	SHEET
	1	50 of 61
		SIZE A0

Option taped. Only used for RENA

Option taped. Only used for RENA

Restraint Control Module  
A,J X200 X201

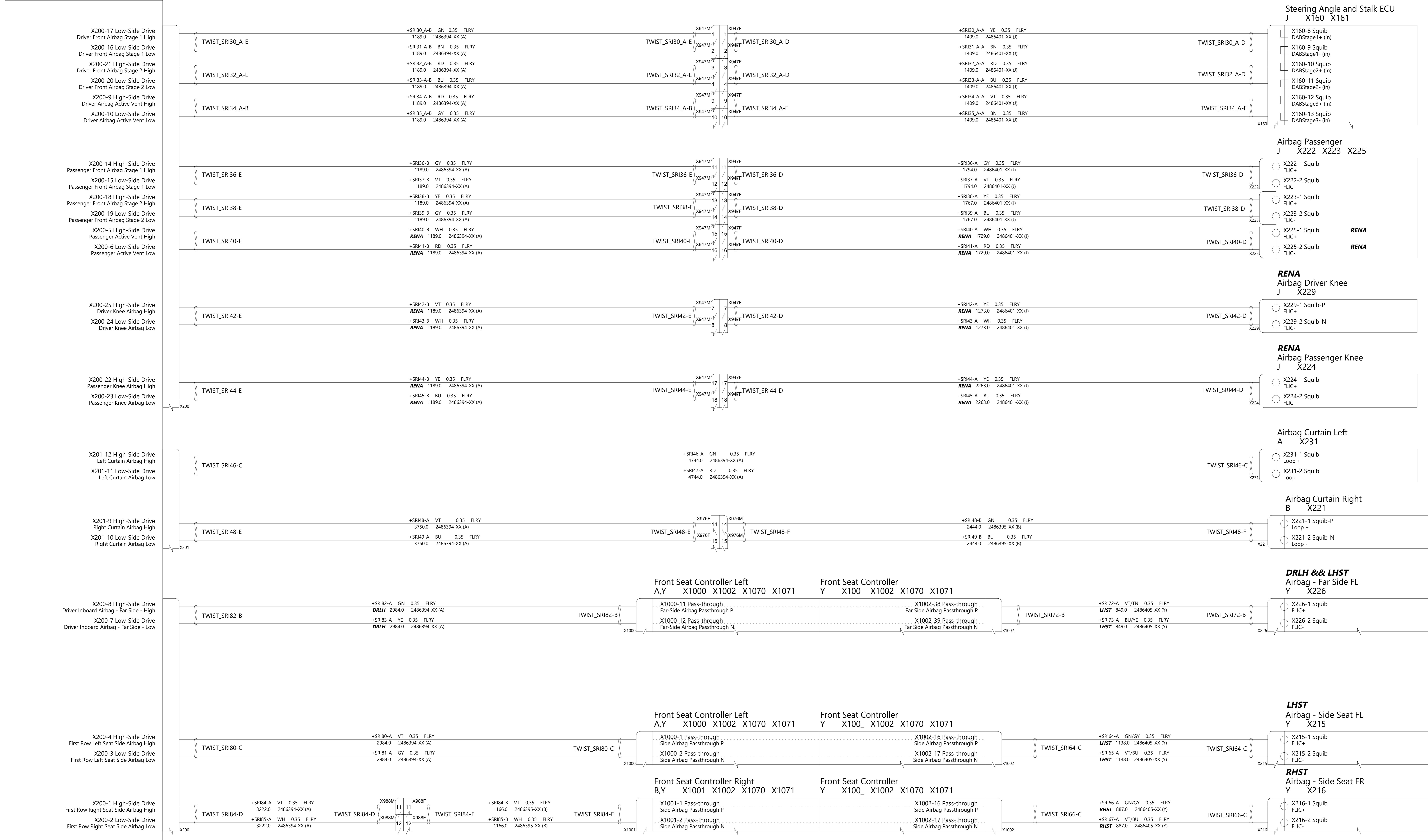

THE INFORMATION CONTAINED HEREIN IS DEEMED TO BE CONFIDENTIAL, PROPRIETARY, AND A TRADE SECRET OF TESLA MOTORS. THIS INFORMATION MAY NOT BE USED, REPRODUCED, OR DISCLOSED AS THE DIRECT OR INDIRECT BASIS FOR THE DEVELOPMENT, MANUFACTURE, OR SALE OF PROCESSES OR PRODUCTS WITHOUT THE EXPRESSED WRITTEN CONSENT OF TESLA MOTORS.

DRAWN	CHECKED	APPROVED
MATERIAL AS SPECIFIED	FINISHING AS SPECIFIED	SCALE NONE
PART NAME Restraints Control Module 2/4		
PART NUMBER	REV	SHEET
	1	54 OF 64
		SIZE A0

Restraint Control Module  
A,J X200 X201

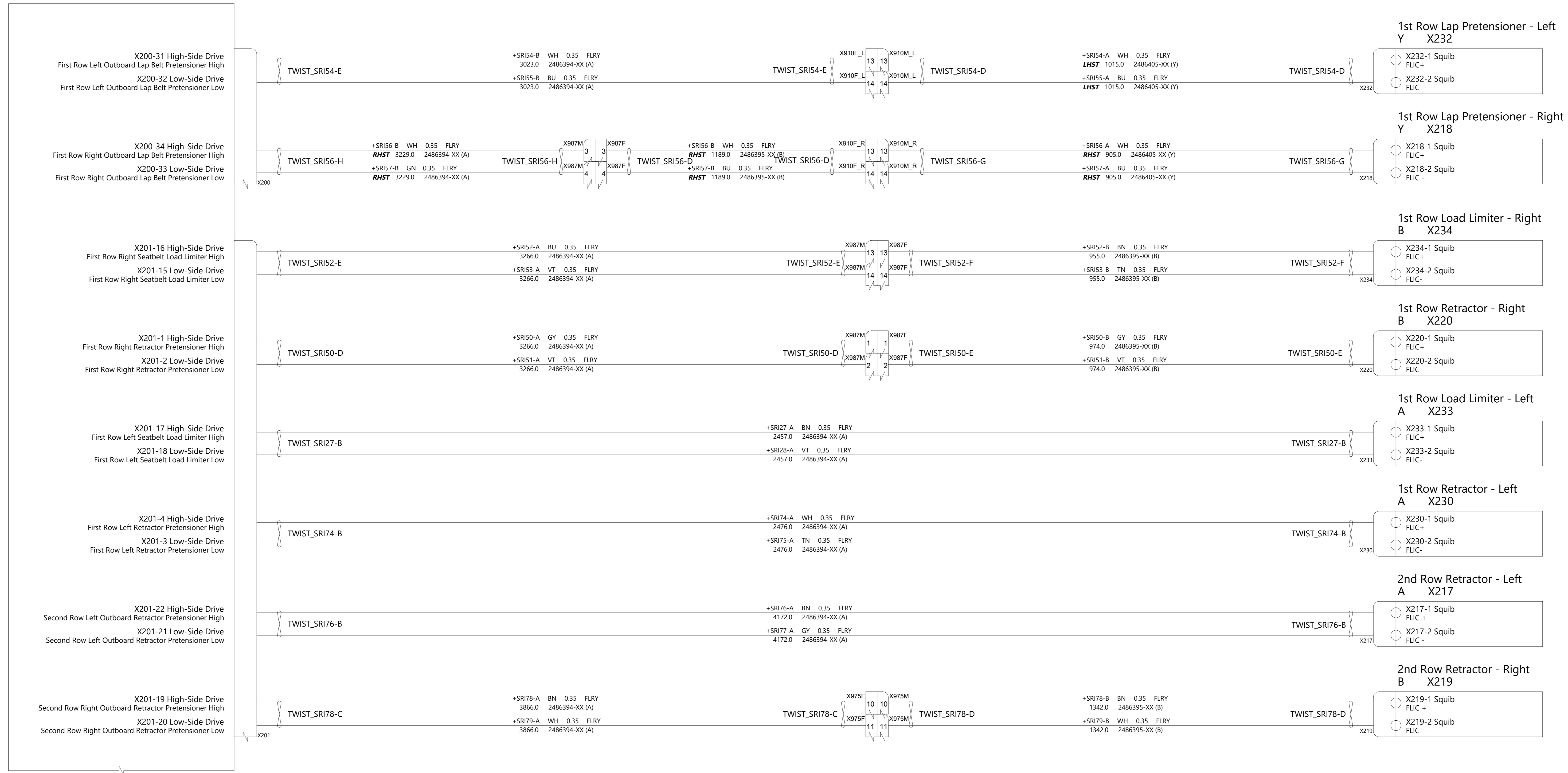

THE INFORMATION CONTAINED HEREIN IS DEEMED TO BE CONFIDENTIAL, PROPRIETARY, AND A TRADE SECRET OF TESLA MOTORS. THIS INFORMATION MAY NOT BE USED, REPRODUCED, OR DISCLOSED AS THE DIRECT OR INDIRECT BASIS FOR THE DEVELOPMENT, MANUFACTURE, OR SALE OF PROCESSES OR PRODUCTS WITHOUT THE EXPRESSED WRITTEN CONSENT OF TESLA MOTORS.

DRAWN	CHECKED	APPROVED
MATERIAL AS SPECIFIED	FINISHING AS SPECIFIED	SCALE NONE
PART NAME Restraints Control Module 3/4		
PART NUMBER	REV	SHEET
	1	52 of 61
		SCALE A0

Restraint Control Module  
A,J X200 X201

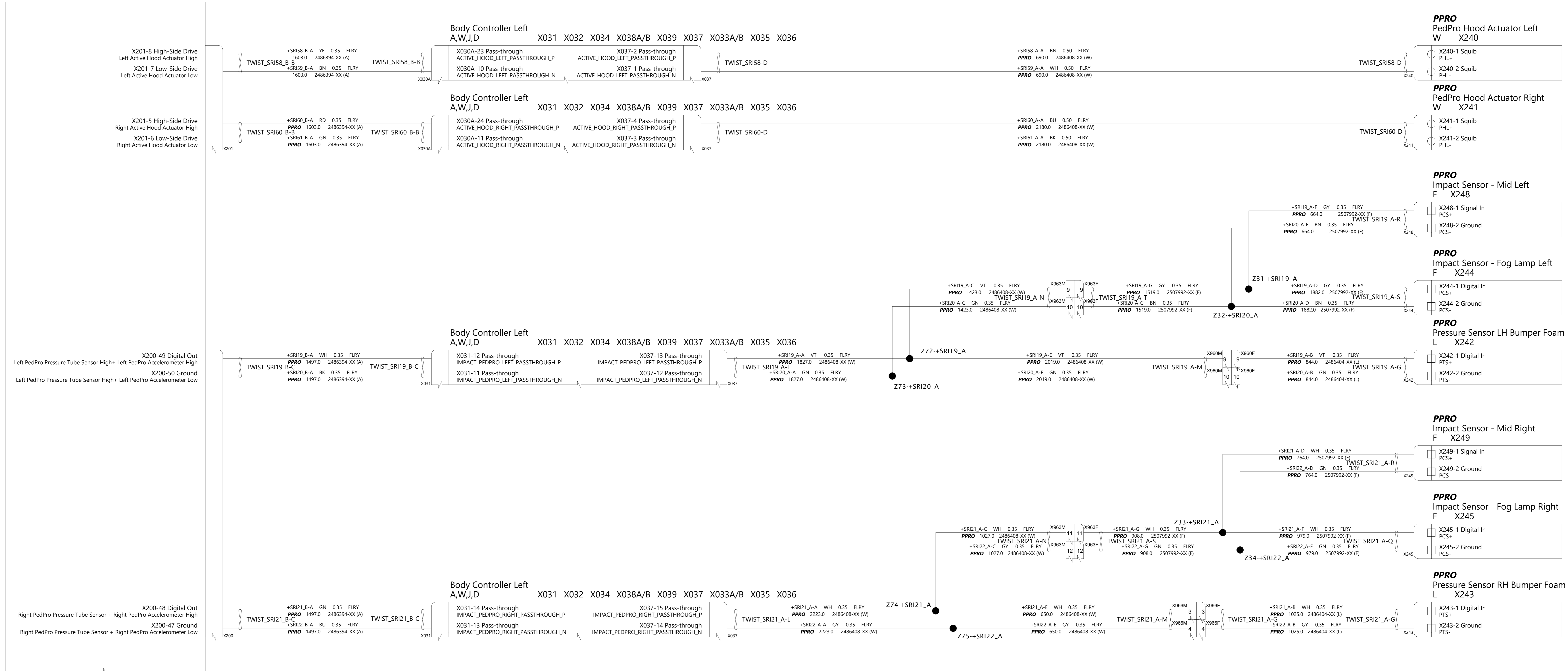

THE INFORMATION CONTAINED HEREIN IS DEEMED TO BE CONFIDENTIAL, PROPRIETARY, AND A TRADE SECRET OF TESLA MOTORS. THIS INFORMATION MAY NOT BE USED, REPRODUCED, OR DISCLOSED AS THE DIRECT OR INDIRECT BASIS FOR THE DEVELOPMENT, MANUFACTURE, OR SALE OF PROCESSES OR PRODUCTS WITHOUT THE EXPRESSED WRITTEN CONSENT OF TESLA MOTORS.

DRAWN	CHECKED	APPROVED
-------	---------	----------

MATERIAL AS SPECIFIED	FINISHING AS SPECIFIED	SCALE NONE
--------------------------	---------------------------	---------------

PART NAME  
Restraints Control Module 4/4

PART NUMBER	REV	SHEET	SIZE
	1	53 OF 61	A0

**Radio Tuner  
T,LT**  
X805F X807F

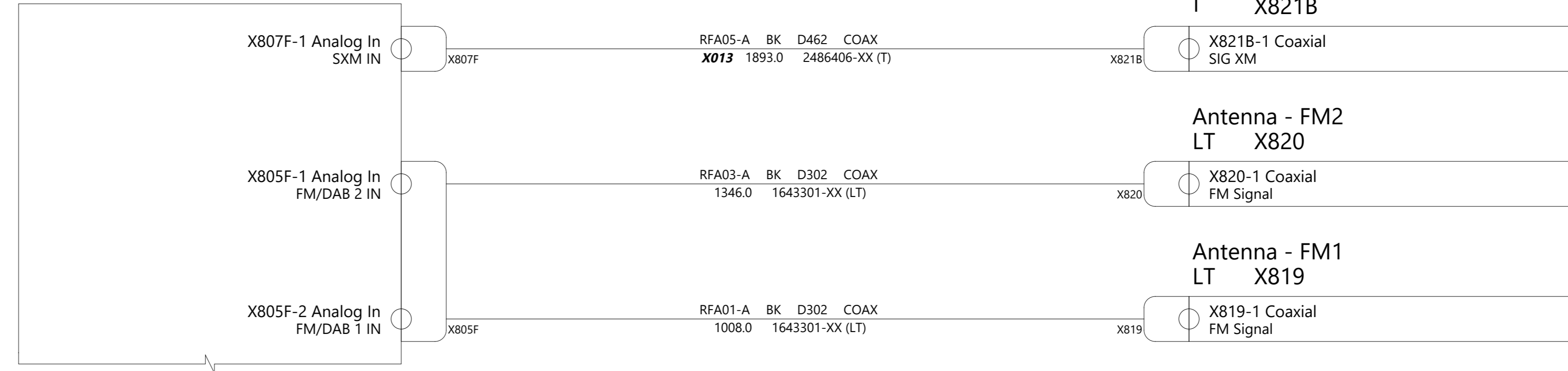

**X013  
Antenna - XM  
T X821B**

**Antenna - FM2  
LT X820**

**Antenna - FM1  
LT X819**

**Antenna - Front Header LTE & WiFi - Left  
B X816 X806**

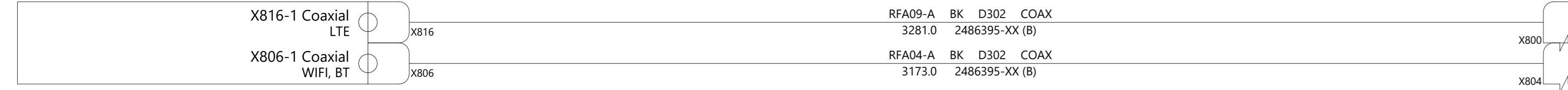

**Antenna - Front Header LTE & WiFi - Right  
B X817 X818**

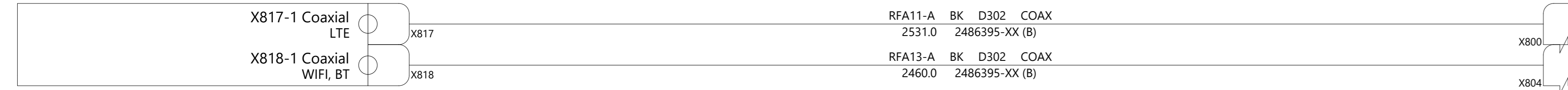

**MCU & Gateway  
W,B,J,A X452 X453 X454 X800 X803 X801 X804 X802 X829 X860 X862 X455**

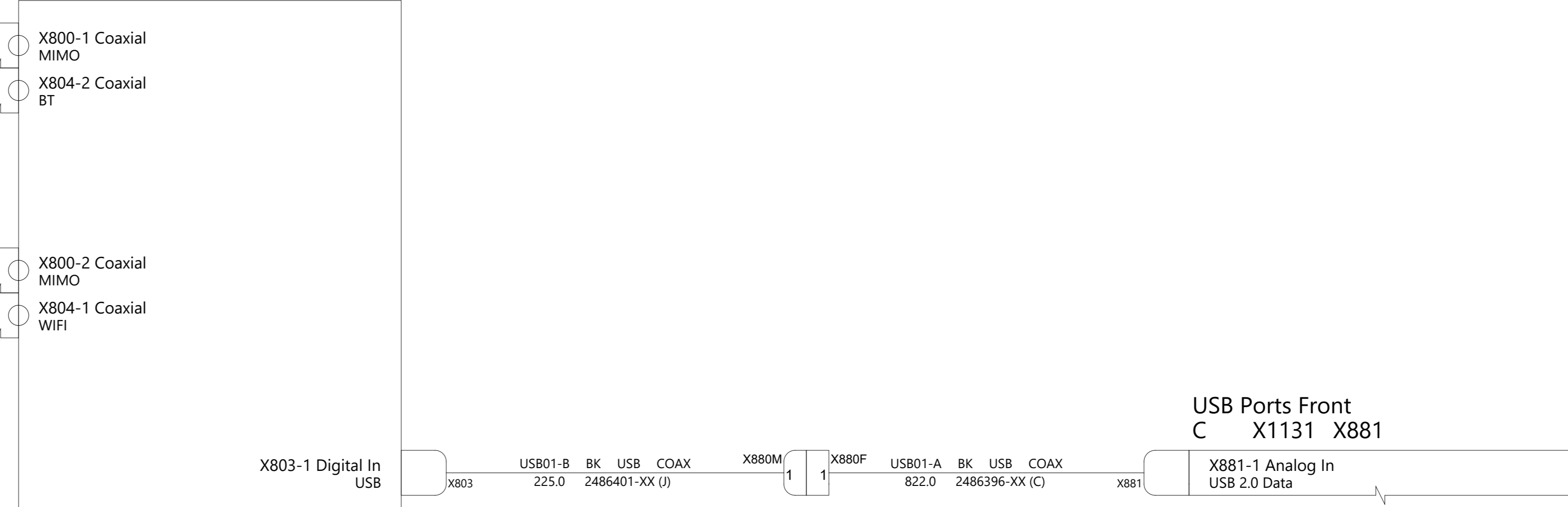

**USB Ports Front  
C X1131 X881**

**Autopilot  
W,J X149 X865 X835 X836 X866 X838 X839 X833 X837 X150**

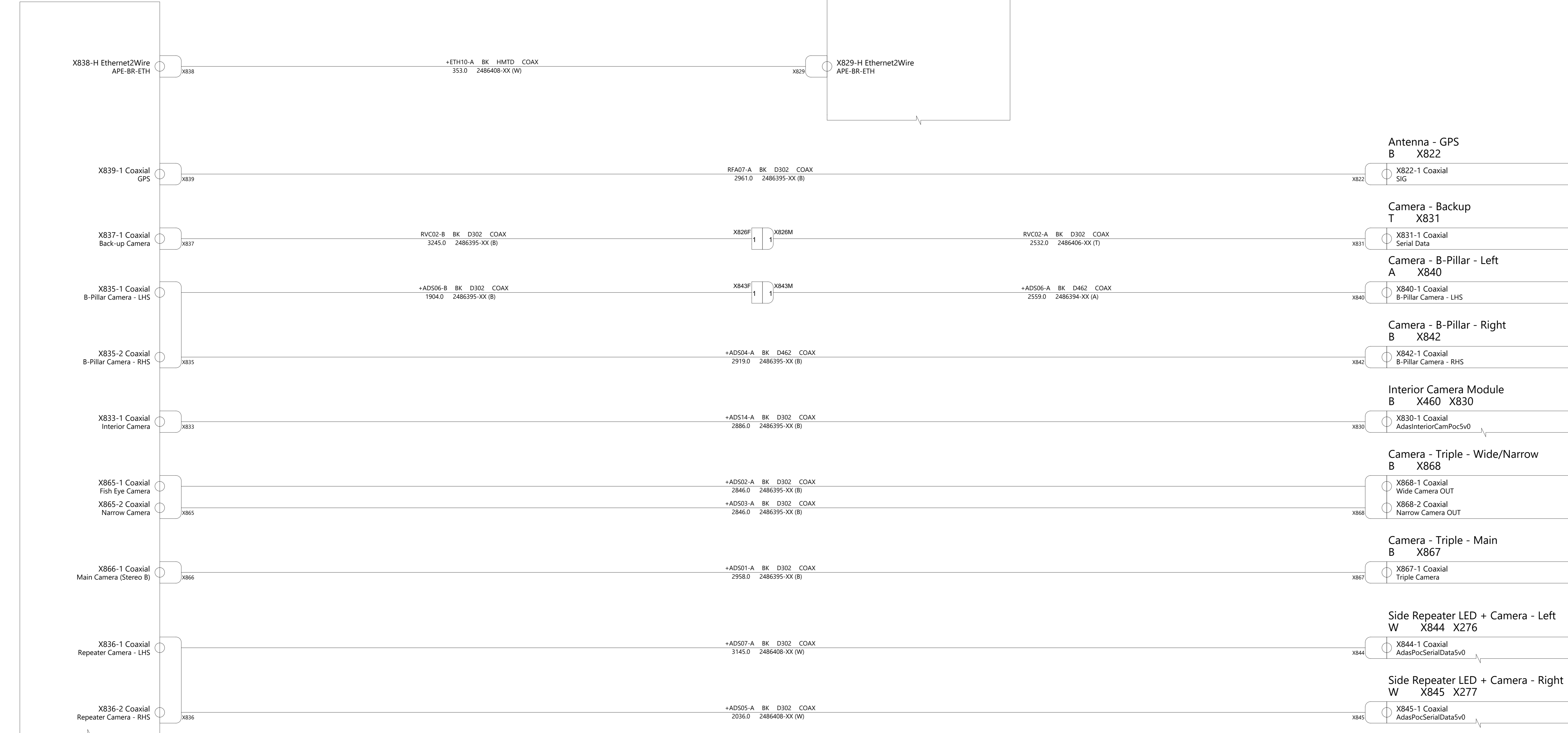

**Antenna - GPS  
B X822**

**Camera - Backup  
T X831**

**Camera - B-Pillar - Left  
A X840**

**Camera - B-Pillar - Right  
B X842**

**Interior Camera Module  
B X460 X830**

**Camera - Triple - Wide/Narrow  
B X868**

**Camera - Triple - Main  
B X867**

**Side Repeater LED + Camera - Left  
W X844 X276**

**Side Repeater LED + Camera - Right  
W X845 X277**



THE INFORMATION CONTAINED HEREIN IS DEEMED TO BE CONFIDENTIAL, PROPRIETARY, AND A TRADE SECRET OF TESLA MOTORS. THIS INFORMATION MAY NOT BE USED, REPRODUCED, OR DISCLOSED AS THE DIRECT OR INDIRECT BASIS FOR THE DEVELOPMENT, MANUFACTURE, OR SALE OF PROCESSES OR PRODUCTS WITHOUT THE EXPRESSED WRITTEN CONSENT OF TESLA MOTORS.

DRAWN	CHECKED	APPROVED
-------	---------	----------

MATERIAL AS SPECIFIED	FINISHING AS SPECIFIED	SCALE NONE
--------------------------	---------------------------	---------------

PART NAME  
RF Cables 1/2

PART NUMBER	REV	SHEET	SIZE
	1	54 OF 61	A0

MCU & Gateway  
W,B,J,A X452 X453 X454 X800 X803 X801 X804 X802 X829 X860 X862 X455

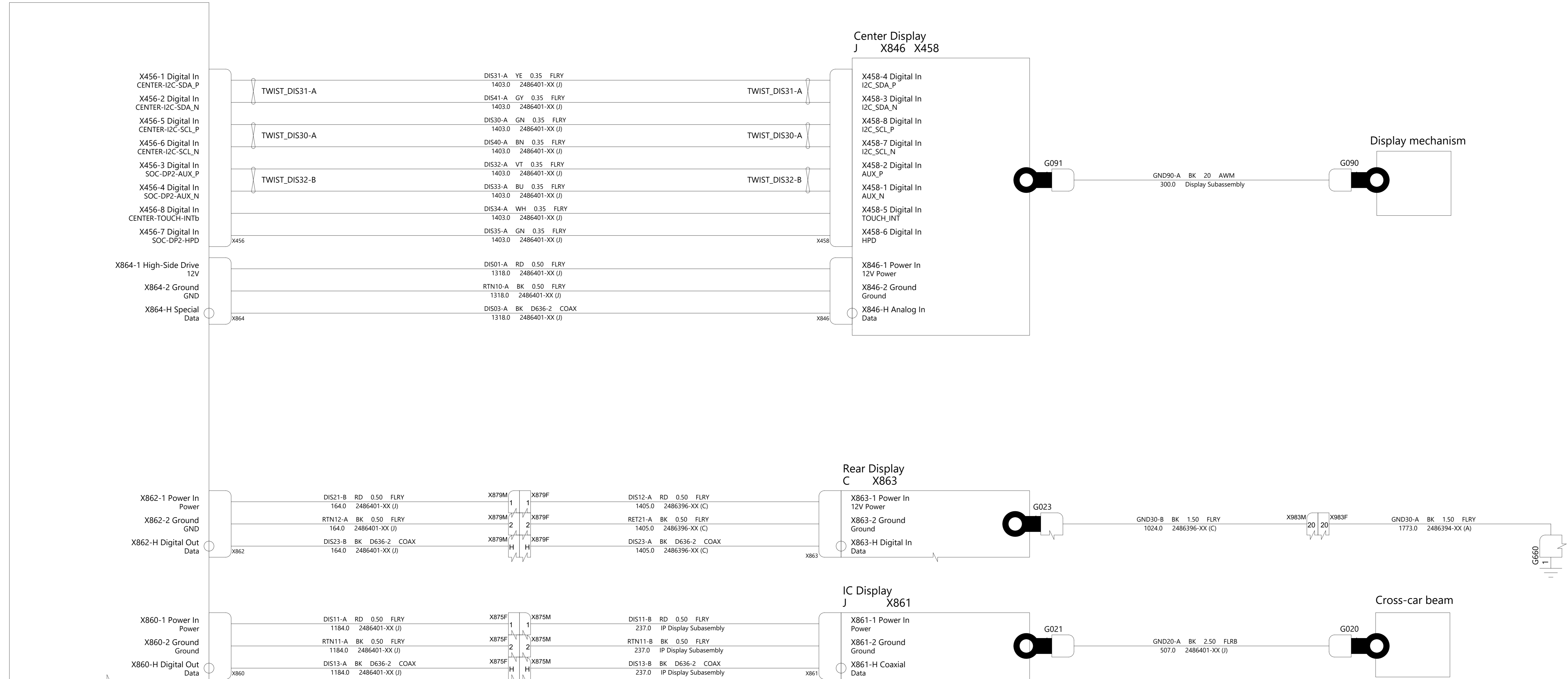

**TESLA**

THE INFORMATION CONTAINED HEREIN IS DEEMED TO BE CONFIDENTIAL, PROPRIETARY, AND A TRADE SECRET OF TESLA MOTORS. THIS INFORMATION MAY NOT BE USED, REPRODUCED, OR DISCLOSED AS THE DIRECT OR INDIRECT BASIS FOR THE DEVELOPMENT, MANUFACTURE, OR SALE OF PROCESSES OR PRODUCTS WITHOUT THE EXPRESSED WRITTEN CONSENT OF TESLA MOTORS.

DRAWN	CHECKED	APPROVED

MATERIAL AS SPECIFIED	FINISHING AS SPECIFIED	SCALE NONE
--------------------------	---------------------------	---------------

PART NAME  
RF Cables 2/2

PART NUMBER	REV	SHEET	SIZE
	1	55 of 61	A0

**Body Controller Left**  
A,W,J,D X031 X032 X034 X038A/B X039 X037 X033A/B X035 X036

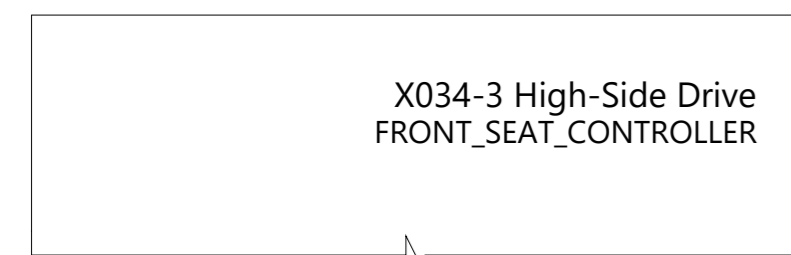

+PAC05-A RD 3.00 FLRB  
2319.0 2486394-XX (A)

**Front Seat Controller Left**  
A,Y X1000 X1002 X1070 X1071

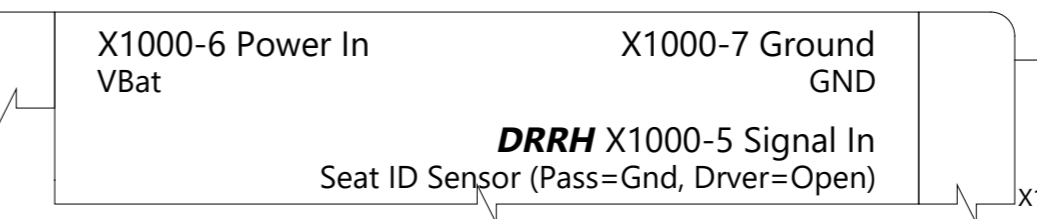

+GLH22-A BK 3.00 FLRB  
2119.0 2486394-XX (A)

**Body Controller Right**  
B,W,J,D X051 X052 X054 X060A/B X062 X053A/B X055 X056 X058 X059

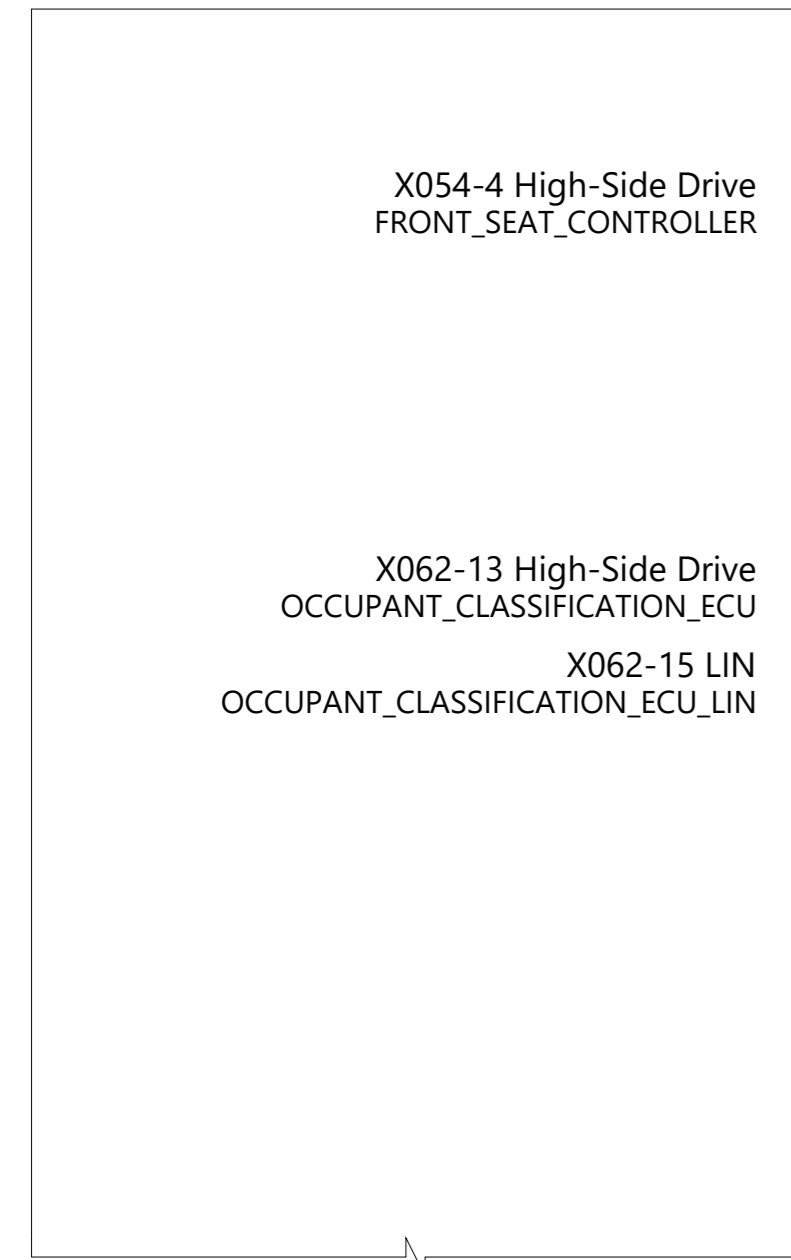

+PAC06-A VT 3.00 FLRB  
2190.0 2486395-XX (B)

**Front Seat Controller Right**  
B,Y X1001 X1002 X1070 X1071

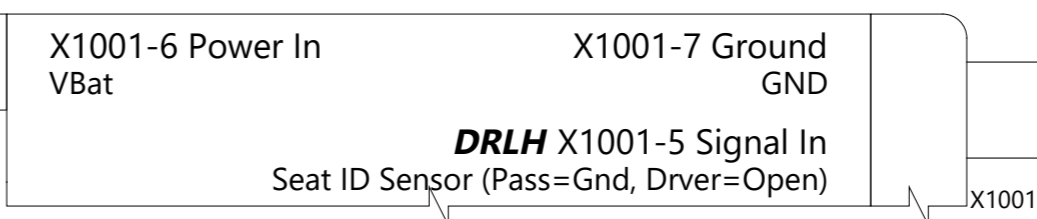

+GRH20-A BK 3.00 FLRB  
1989.0 2486395-XX (B)

+GRH21-A BK 3.00 FLRB  
DRLH 1989.0 2486395-XX (B)

**Occupancy Classification System**  
Y X1075

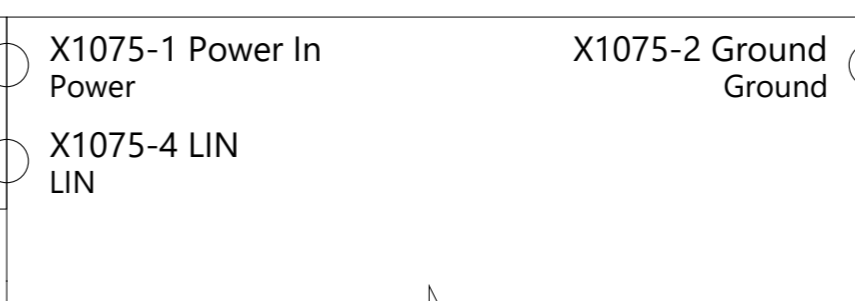

+OCS02-A RD 0.50 FLRY  
DRLH & RHST 672.0 2486405-XX (Y)

+CLN16-A GN 0.50 FLRY  
DRLH & RHST 672.0 2486405-XX (Y)

+OCS02-B RD 0.35 FLRY  
DRLH & RHST 2123.0 2486395-XX (B)

+CLN16-B GN 0.35 FLRY  
DRLH & RHST 2123.0 2486395-XX (B)

+GRH56-A BK 0.50 FLRY  
RHST 672.0 2486405-XX (Y)

+GRH56-B BK 0.35 FLRY  
DRLH 2018.0 2486395-XX (B)

**Front Seat Controller**  
Y X100\_ X1002 X1070 X1071

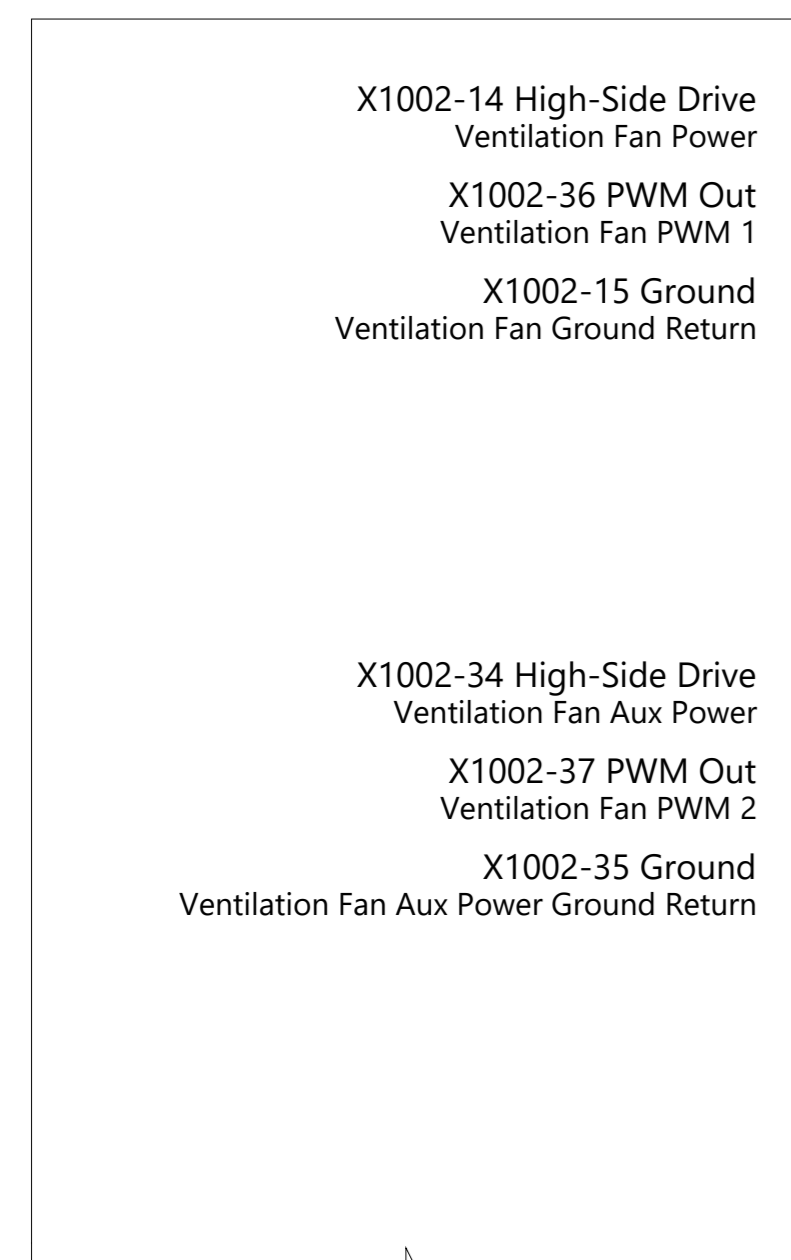

SCE50-A YE 0.35 FLRY  
1153.0 2486405-XX (Y)

SCE51-A GN 0.35 FLRY  
1153.0 2486405-XX (Y)

RTN69-A BN 0.35 FLRY  
1153.0 2486405-XX (Y)

SCE53-A YE 0.35 FLRY  
582.0 2486405-XX (Y)

SCE52-A VT 0.35 FLRY  
582.0 2486405-XX (Y)

RTN68-A BN 0.35 FLRY  
582.0 2486405-XX (Y)

**Front Seat Backrest Ventilation**  
Y X1028

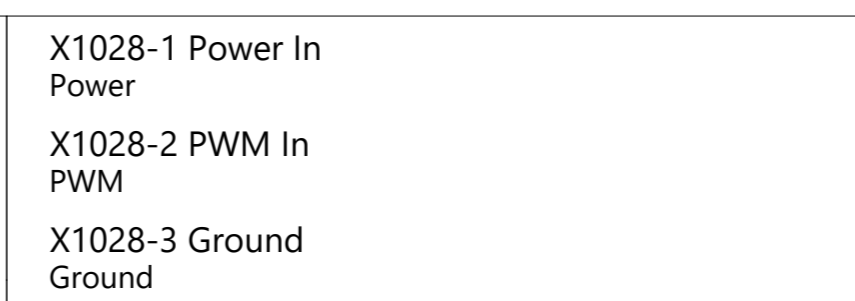

**Front Seat Cushion Ventilation**  
Y X1029

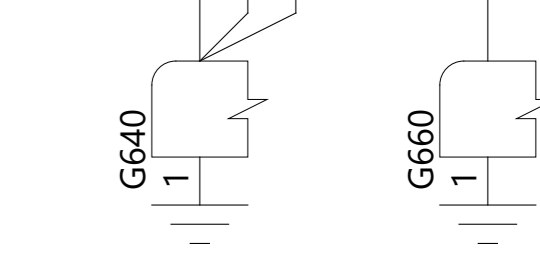

THE INFORMATION CONTAINED HEREIN IS DEEMED TO BE CONFIDENTIAL, PROPRIETARY, AND A TRADE SECRET OF TESLA MOTORS. THIS INFORMATION MAY NOT BE USED, REPRODUCED, OR DISCLOSED AS THE DIRECT OR INDIRECT BASIS FOR THE DEVELOPMENT, MANUFACTURE, OR SALE OF PROCESSES OR PRODUCTS WITHOUT THE EXPRESSED WRITTEN CONSENT OF TESLA MOTORS.

DRAWN	CHECKED	APPROVED
MATERIAL AS SPECIFIED		SCALE NONE
PART NAME Seat Front 1/2		
PART NUMBER	REV	SHEET
	1	56 of 61
		SIZE A0



# SAME SEAT SCHEMATICS FOR BOTH FRONT LEFT AND RIGHT SEATS

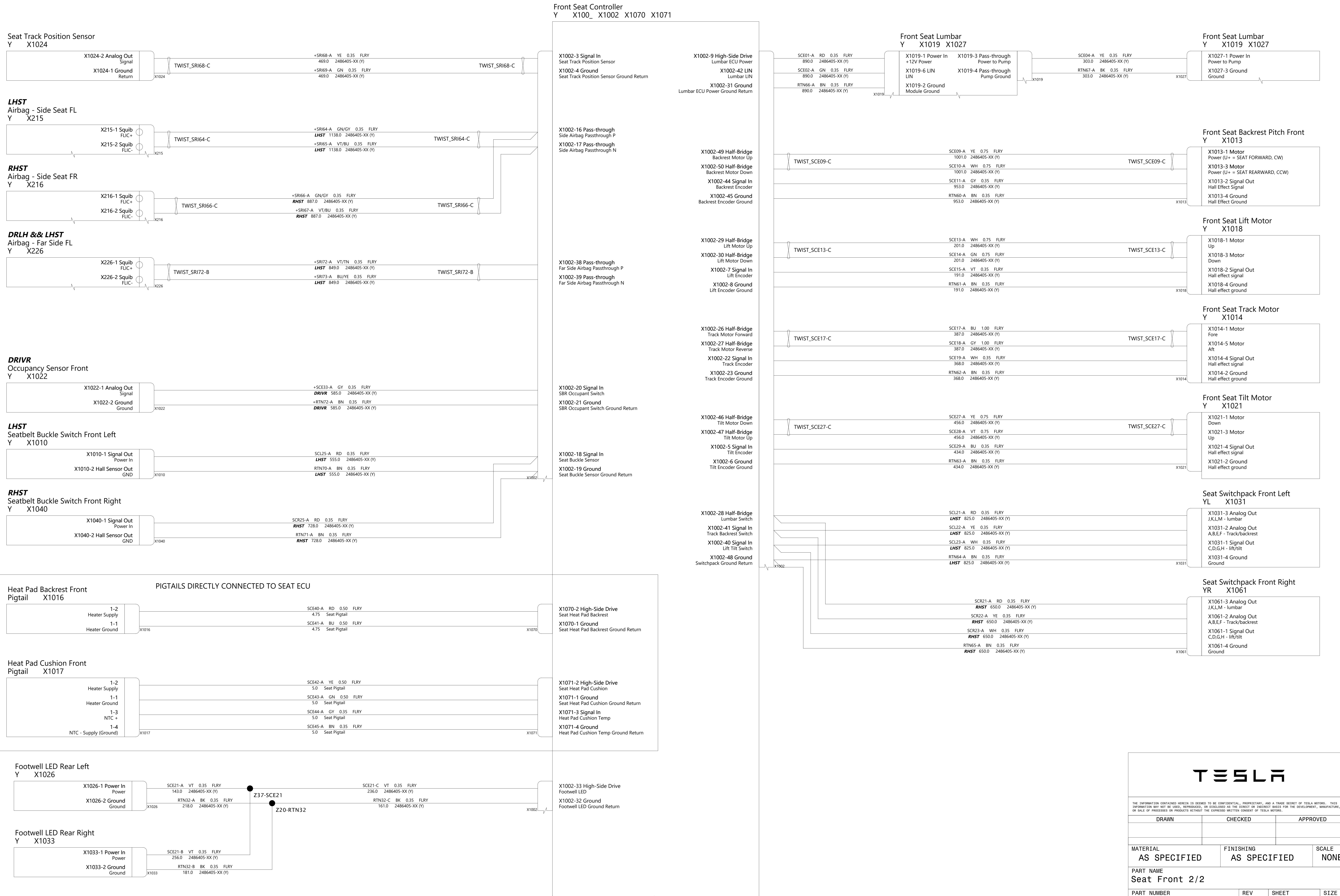

DRAWN				CHECKED		APPROVED	
MATERIAL AS SPECIFIED		FINISHING AS SPECIFIED		SCALE NONE			
PART NAME <b>Seat Front 2/2</b>							
PART NUMBER		REV	SHEET	SCALE			
		1	57 of 61	A0			

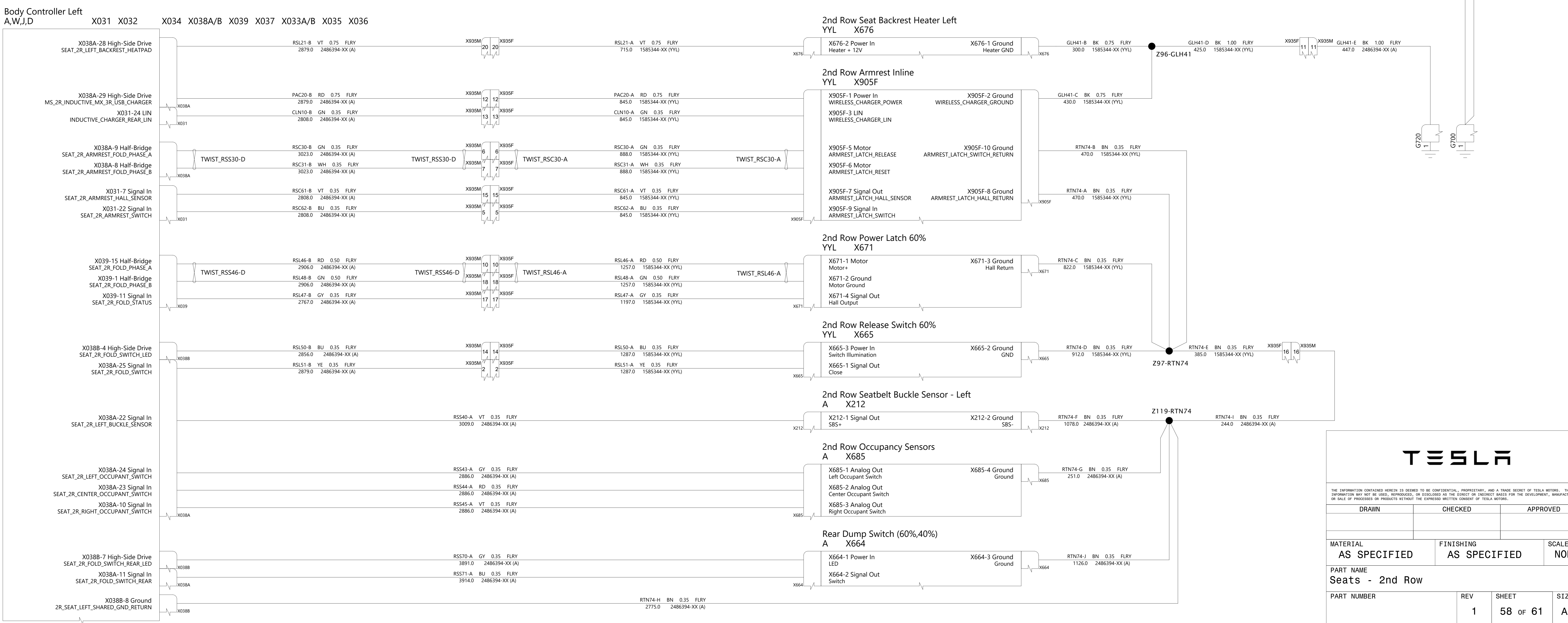
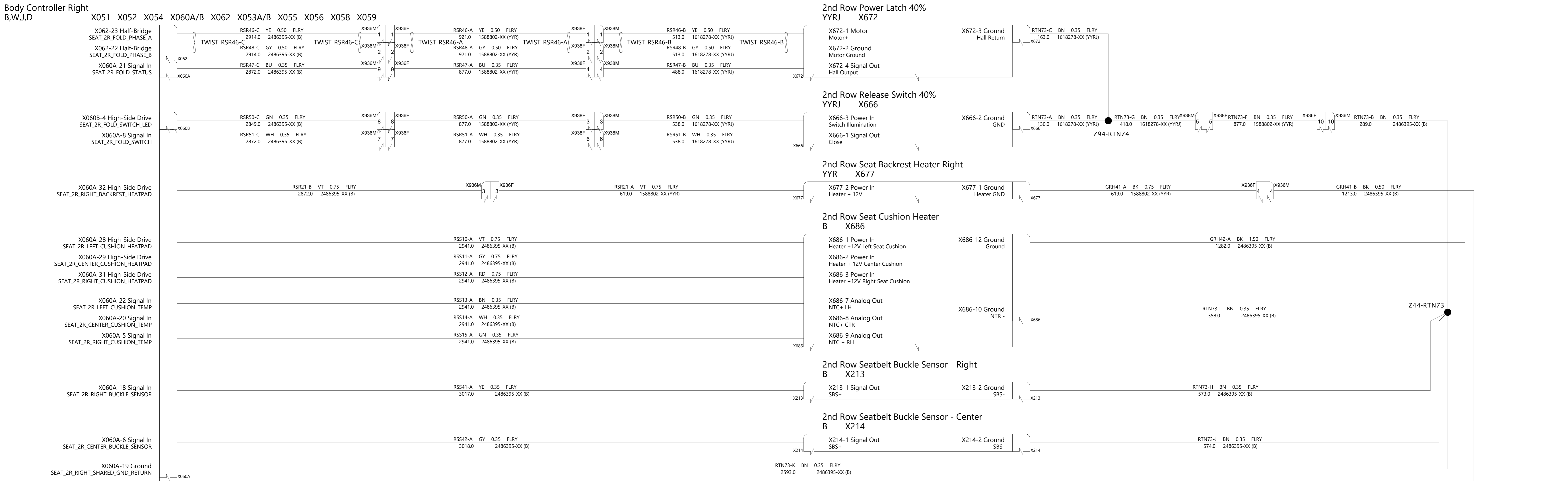

<b>TESLA</b>			
THE INFORMATION CONTAINED HEREIN IS DEEMED TO BE CONFIDENTIAL, PROPRIETARY, AND A TRADE SECRET OF TESLA MOTORS. THIS INFORMATION MAY NOT BE USED, REPRODUCED, OR DISCLOSED AS THE DIRECT OR INDIRECT BASIS FOR THE DEVELOPMENT, MANUFACTURE, OR SALE OF PROCESSES OR PRODUCTS WITHOUT THE EXPRESSED WRITTEN CONSENT OF TESLA MOTORS.			
DRAWN	CHECKED	APPROVED	
MATERIAL AS SPECIFIED	FINISHING AS SPECIFIED	SCALE NONE	
PART NAME <b>Seats - 2nd Row</b>			
PART NUMBER	REV	SHEET	SIZE
	1	58 of 61	A0

Security Controller  
B X488

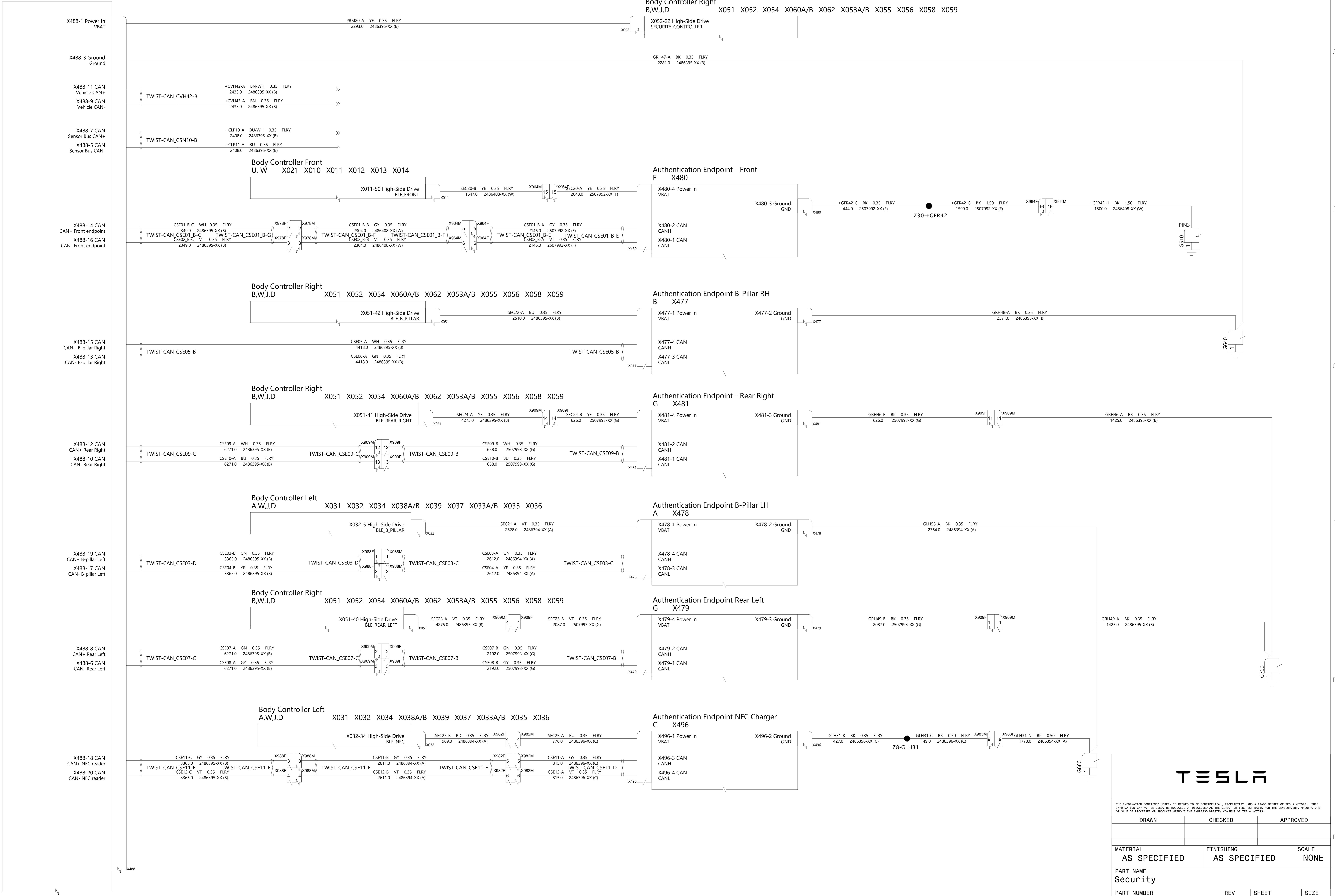

THE INFORMATION CONTAINED HEREIN IS DEEMED TO BE CONFIDENTIAL, PROPRIETARY, AND A TRADE SECRET OF TESLA MOTORS. THIS INFORMATION MAY NOT BE USED, REPRODUCED, OR DISCLOSED AS THE DIRECT OR INDIRECT BASIS FOR THE DEVELOPMENT, MANUFACTURE, OR SALE OF PROCESSES OR PRODUCTS WITHOUT THE EXPRESSED WRITTEN CONSENT OF TESLA MOTORS.

DRAWN	CHECKED	APPROVED
MATERIAL AS SPECIFIED	FINISHING AS SPECIFIED	SCALE NONE
PART NAME Security		
PART NUMBER	REV	SHEET
	1	59 of 61
		SIZE A0

Body Controller Right  
B,W,J,D X051 X052 X054 X060A/B X062 X053A/B X055 X056 X058 X059

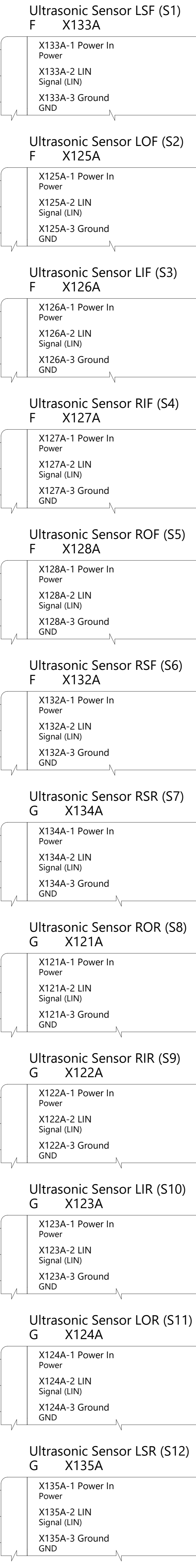

THE INFORMATION CONTAINED HEREIN IS DEEMED TO BE CONFIDENTIAL, PROPRIETARY, AND A TRADE SECRET OF TESLA MOTORS. THIS INFORMATION MAY NOT BE USED, REPRODUCED, OR DISCLOSED AS THE DIRECT OR INDIRECT BASIS FOR THE DEVELOPMENT, MANUFACTURE, OR SALE OF PROCESSES OR PRODUCTS WITHOUT THE EXPRESSED WRITTEN CONSENT OF TESLA MOTORS.

DRAWN	CHECKED	APPROVED
MATERIAL AS SPECIFIED	FINISHING AS SPECIFIED	SCALE NONE
PART NAME <b>Ultrasonics</b>		
PART NUMBER	REV	SHEET
	1	61 OF 61
SIZE		
A0		